



Features

- ISM 2.4 GHz Operating Frequency
- Fully Compliant with 2.4G /ZigBee Specifications
- Wireless Transmission Range up to 700 m
- GUI Configuration Software (Windows Version)
- 8 Differential Analog Input Channels (TC, mV, V)
- Individual Channel Configuration
- Open Thermocouple Detection
- Overvoltage Protection up to 240 Vrms
- DIN-Rail Mounting



Introduction

The ZT-2018 a wireless 16-bit, 8-channel differential analog input module with an extremely high quality protection mechanism where overvoltage protection is up to 240 Vrms. Input type includes current, voltage as well as thermocouple. and is much more suitable for harsh environments. Moreover, a newly-added feature that enables open thermocouple detection makes the ZT-2018 more attractive than ever. The ZT-2018 is also qualified for 4 kV ESD protection and 3000 VDC intra-module isolation. Users can easily configure the module address, protocol, checksum, ZT-PID, ZT-channel and type code settings using a combination of rotary and DIP switches.

System Specifications

Communication Interface	
Wireless Standards	ZigBee 2007 Pro
Transmission power	11 dBm (FCC Certified) (Max 19 dBm)
2.4 GHz Antenna	5 dBi Omni directional
Transmission Range (LoS)	700 m (Typical)
Certification	CE/FCC,FCC ID
Max. Slaves in a zigbee network	255
ZB-100R/ZB-100T Supported	-
Protocols	Supports DCON and Modbus RTU Protocols
Hot Swap	Rotary and DIP switch
LED Indicators	
Power	1 LED, red
ZigBee Communication	1 LED, green
Power	
Power Consumption	1.2 W Max.
Mechanical	
Flammability	Fire Retardant Materials (UL94-V0 Level)
Dimensions (W x L x H)	33 mm x 87 mm x 107 mm
Installation	DIN-Rail
Environment	
Operating Temperature	-25 °C ~ +75 °C
Storage Temperature	-30 °C ~ +80 °C
Relative Humidity	10 ~ 90% RH, Non-condensing

Thermocouple Type

Type Code	Temperature Range	Type Code	Temperature Range
J	-210 ~ +760°C	B	0 ~ +1820°C
K	-270 ~ +1372°C	N	-270 ~ +1300°C
T	-270 ~ +400°C	C	0 ~ +2320°C
E	-270 ~ +1000°C	L	-200 ~ +800°C
R	0 ~ +1768°C	M	-200 ~ +100°C
S	0 ~ +1768°C	L2 (DIN43710)	-200 ~ +900°C

Applications

Building Automation, Factory Automation, Machine Automation, Remote Maintenance, Remote Diagnosis, Testing Equipment.

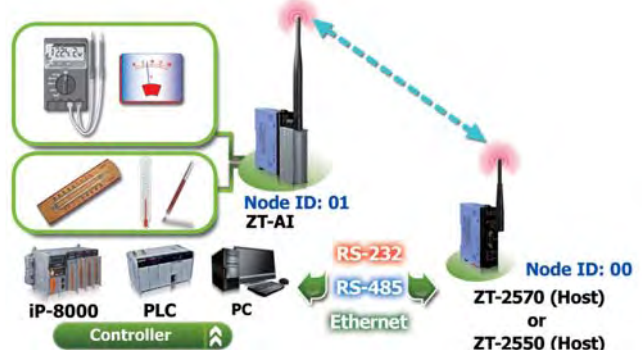

I/O Specifications

Analog Input	
Input Channels	8 Differential
Input Types	+/-15 mV, +/-50 mV, +/-100 mV, +/-500 mV, +/-1V, +/-2.5V, +/-20 mA, 0 ~ 20 mA or 4 ~ 20 mA Thermocouple (J, K, T, E, R, S, B, N, C, L, M, LDIN43710) (Requires Optional External 125 Ω Resistor for current input).
Resolution	16-bit
Sampling Rate	10 Samples/Sec. (Total)
Accuracy	+/-0.1% of FSR
-3dB Bandwidth	15.7 Hz
Zero Drift	+/-10 μV/°C
Span Drift	+/-25 ppm/°C
Common Mode Rejection	86 dB min.
Normal Mode Rejection	100 dB
Input Impedance	>400 kΩ
Open Thermocouple Detection	Yes
Overvoltage Protection	240 Vrms
Intra-module Isolation, Field-to-Logic	3000 Vdc
ESD Protection	+/-4 kV contact for each channel



Wiring

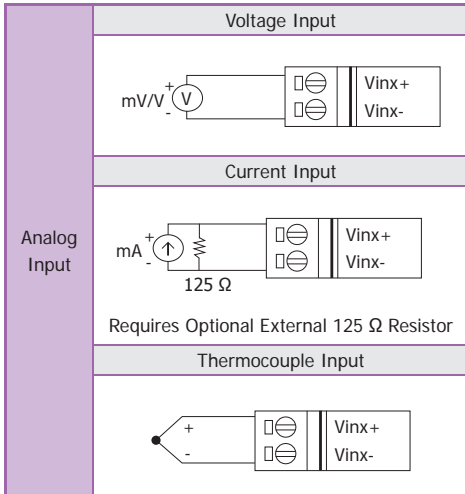

Appearance

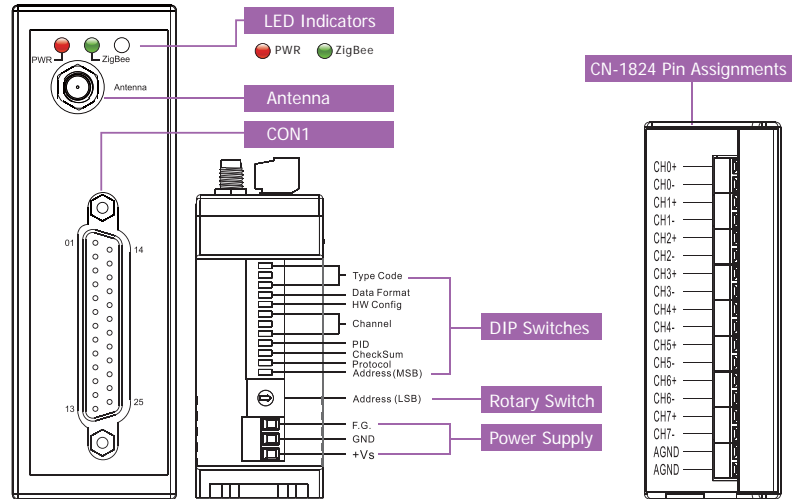

Dimensions (Units: mm)

ZT-2018

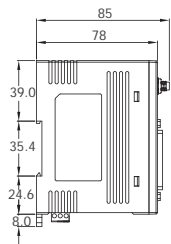

Left Side View

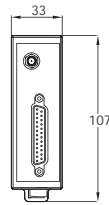

Front View

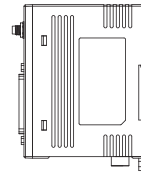

Right Side View

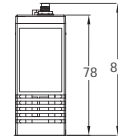

Top View



Rear View

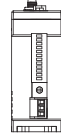

Bottom View

ZT-2018 + CN1824

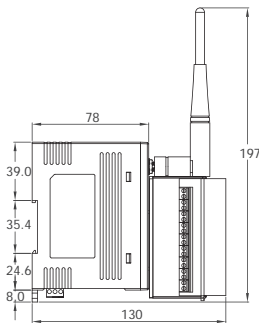

Left Side View

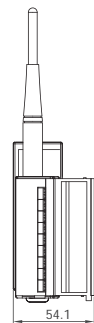

Front View

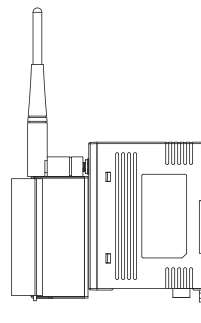

Right Side View

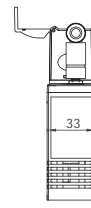

Top View

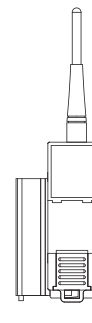

Rear View

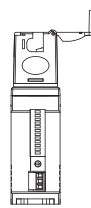

Bottom View

Ordering Information

ZT-2018 CR

Wireless 8-channel Analog Input Module with High Voltage Protection (RoHS) (Long Range)

Important Note: Zigbee Data Acquisition modules need a Zigbee host converter to coordinate the data transmission route. Please remember to order a ZT-2550, ZT-2570 ZigBee host converter when you purchase Zigbee Data Acquisition products.

Accessories

MDR-20-24	24 VDC/1.0 A, 24 W Power Supply with DIN-Rail Mounting
ZT-2510 CR	ZigBee Repeater (RoHS)
ZT-2550 CR	RS-485/RS-232 to High Power Amplifier ZigBee Converter (Host) (RoHS)
ZT-2570 CR	Ethernet/RS-485/RS-232 to High Power Amplifier ZigBee Converter (Host) (RoHS)



PLCs



Adquisición



Instrumentos



Registradores



Potencia



HMIs



Switches



Movimiento



Sensores



Convertidores



Teclados



SCADA



Telemetría

¡Tu sitio de automatización!