

Digital Oscilloscope
 Waveform Generator
 DC Power Supply
 Digital Multimeter
 Spectrum Analyzer
 Handheld Oscilloscope
 Probes & Accessories

SIGLENT TECHNOLOGIES
PRODUCT CATALOG



SIGLENT TECHNOLOGIES Co., Ltd.

-The Best Value in Electronic Test & Measurement.

SIGLENT has been providing test & measurement solutions for almost 14 years from its headquarter in Shenzhen, China. There are more than 300 employees, one third of whom are high-educated R&D engineers.

SIGLENT has many patent technologies. We are dedicated to develop sophisticated and high quality digital oscilloscopes, waveform generators, handheld digital oscilloscopes, spectrum analyzers and DC power supplies, digital multimeters. We strive to deliver the highest quality of customer service and satisfaction to our customers.



SIGLENT provides the following instruments:

- Super Phosphor Oscilloscope
- Digital Oscilloscope
- Waveform Generator
- DC Power Supply
- Digital Multimeter
- Spectrum Analyzer
- Handheld Oscilloscope
- Probes & Accessories





SDS2000X Super Phosphor Oscilloscope

Key Features

- 70 MHz, 100 MHz, 200 MHz, 300 MHz models
- Real-time sampling rate up to 2 GSa/s
- New generation of SPO technology
 - Waveform capture rate up to 140,000 wfm/s (normal mode), and 500,000 wfm/s (sequence mode)
 - Supports 256-level intensity grading and color temperature display
 - Record length up to 140 Mpts
 - Digital trigger system
- Intelligent trigger: Edge, Slope, Pulse, Window, Runt, Interval, Dropout, Pattern and Video (HDTV supported)
- Serial bus triggering and decoder, supports protocols IIC, SPI, UART, RS232, CAN and LIN
- Low background noise, supports 1 mV/div to 10 V/div voltage scales
- 10 types of one-button shortcuts, including Auto Setup, Default, Cursors, Measure, Roll, History, Display/Persist, Clear Sweeps, Zoom and Print
- Segmented acquisition (Sequence) mode, dividing the maximum record length into multiple segments (up to 80,000), according to trigger conditions set by the user, with a very small dead time segment to capture the qualifying event
- History waveform record (History) function, the maximum recorded waveform length is 80,000 frames
- Automatic measurement function on 37 parameters, supports statistics, Gating measurement, Math measurement, History measurement and Ref measurement
- Math function (FFT, addition, subtraction, multiplication, division, integration, differential, square root)
- High Speed hardware based Pass/ Fail function
- 16 Digital channels (MSO), Maximum waveform capture rate up to 500 MSa/s, Record length up to 140 Mpt/CH
- 25 MHz function/arbitrary waveform generator, built-in 10 types of waveforms
- Large 8 inch TFT-LCD display with 800 * 480 resolution
- Abundant interfaces: USB Host, USB Device (USBTMC), LAN (VXI-11), Pass/Fail, Trigger Out
- Supports SCPI remote control commands
- Supports Multi-language display and embedded online help

Digital Oscilloscope

Characteristics

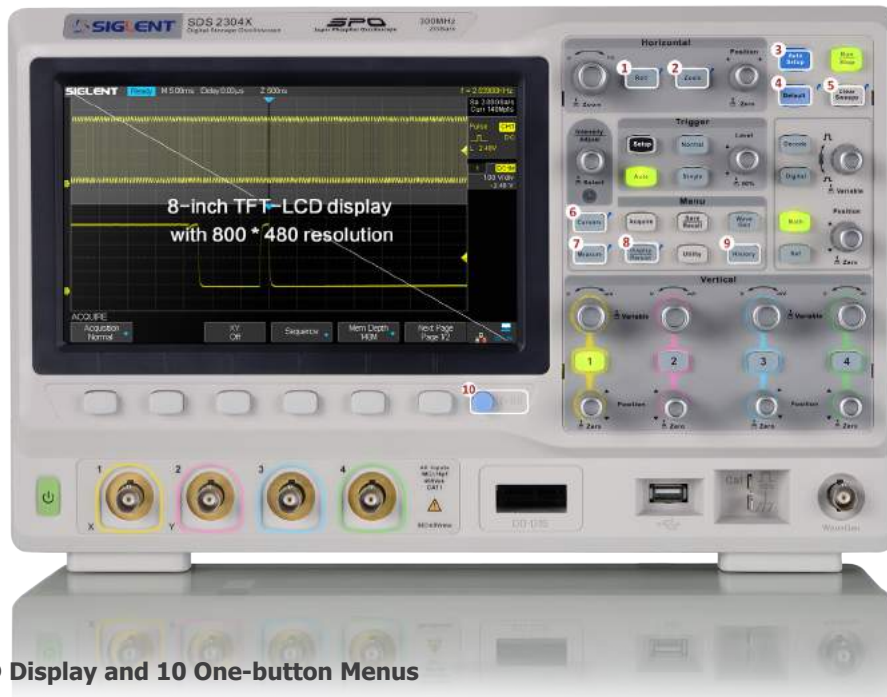

• 8 inch TFT-LCD Display and 10 One-button Menus

- 8-inch TFT-LCD display with 800 * 480 resolution
- Most commonly used functions are accessible using 10 different one-button operation keys: Auto Setup, Default, Cursors, Measure, Roll, History, Display/Persist, Clear Sweeps, Zoom and Print.
- Supports auto detection of 10X probe with read-out port (200 MHz and 300 MHz versions only)

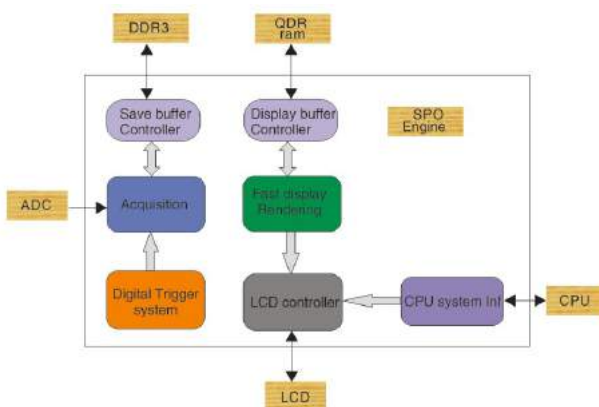

SPO Super Phosphor Oscilloscope

- Waveform capture rate up to 140,000 wfm/s (normal mode), and 500,000 wfm/s (sequence mode)
- Supports 256-level intensity grading and color temperature display
- Record length up to 140 Mpts
- Digital trigger system

• Waveform Capture Rate up to 500,000 wfm/s

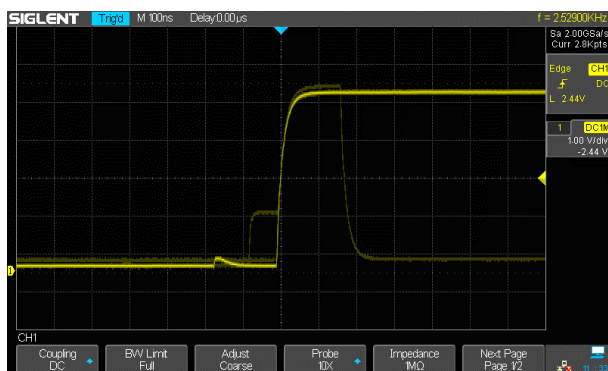

With a waveform capture rate of up to 500,000 wfm/s (sequence mode), the oscilloscope can easily capture the unusual or low-probability events

• Record Length of up to 140 Mpts



Using hardware-based Zoom technique and record length of up to 140 Mpts, users are able to use a higher sampling rate to capture more of the signal, and then quickly zoom in to focus on the area of interest

• 256-level Intensity Grading and Color Temperature Display

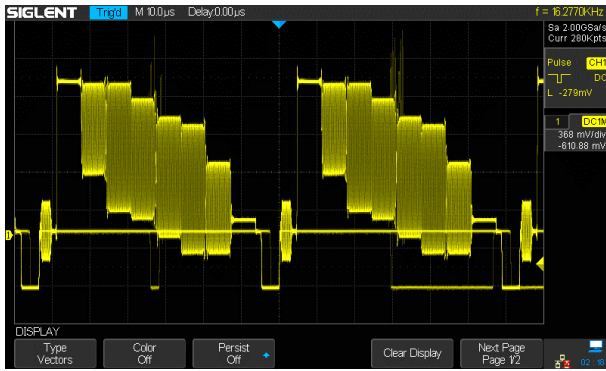

256-level intensity grading display on waveform

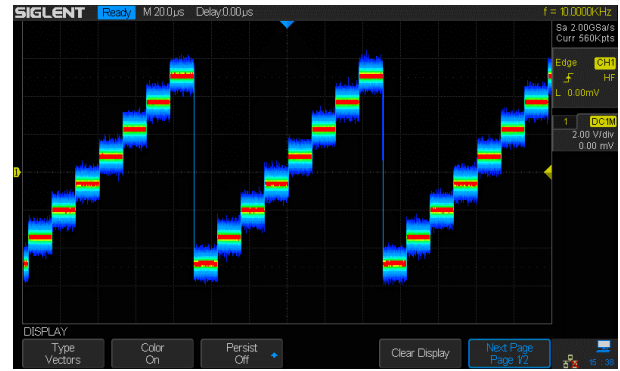

Color temperature display

• Abundant Trigger Functions

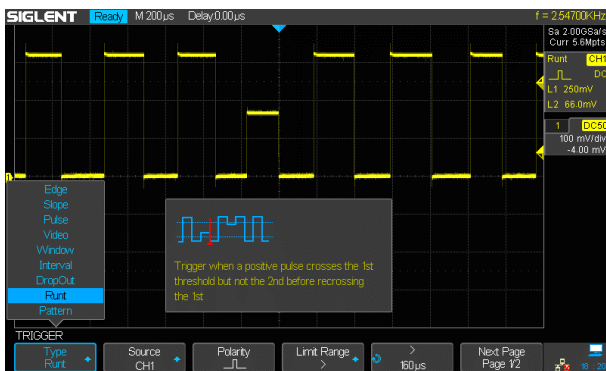

Edge, Slope, Pulse, Video, Windows, Runt, Interval, Dropout, Pattern, IIC, SPI, UART/RS232, LIN and CAN

• History Mode

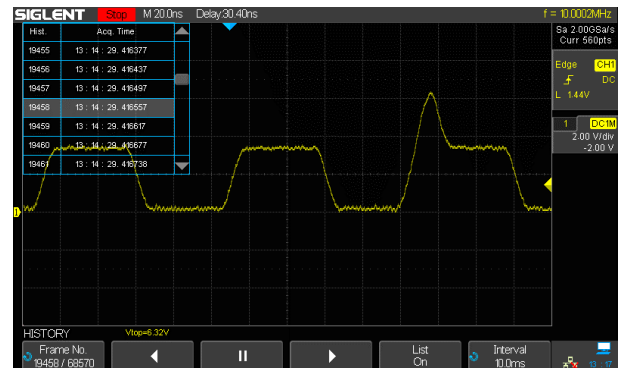

History function can record up to 80,000 frames of waveforms. The recording is executed automatically, so that the customer can play back the history waveforms at any time to observe unusual events, and locate the source quickly through the cursors or measurements. Located on the keyboard Panel, this function is easily accessible

• Sequence Mode

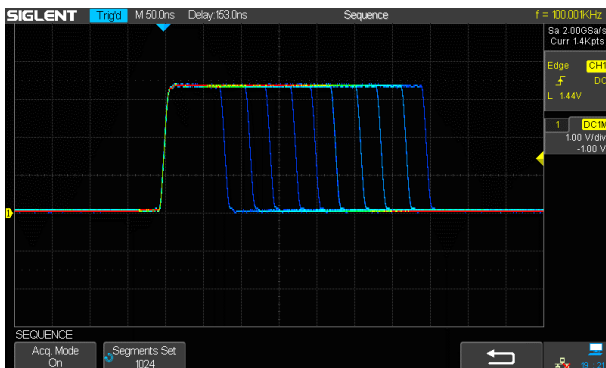

Segmented memory collection will store the waveform into multiple (up to 80,000) memory segments and each segment will store a triggered waveform, as well the dead time information. The dead time between segments could be as small as 2 μ s. All the segments can be play back using History function.

• Comprehensive Statistical Functions

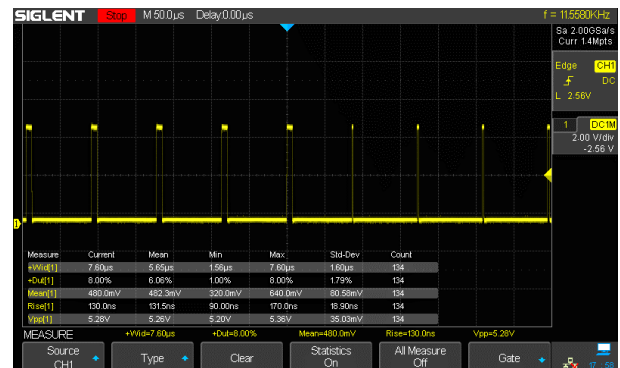

Parametric statistical functions to display 5 parameters of any measurements: current, mean, minimum value, maximum value, and standard deviation. The measurement count is also displayed. The maximum number of measurements that can be run and simultaneously analyzed statistically is five. Supports Gating measurements, Math measurement, History measurement and Ref measurement

Digital Oscilloscope

• Advanced Math Function

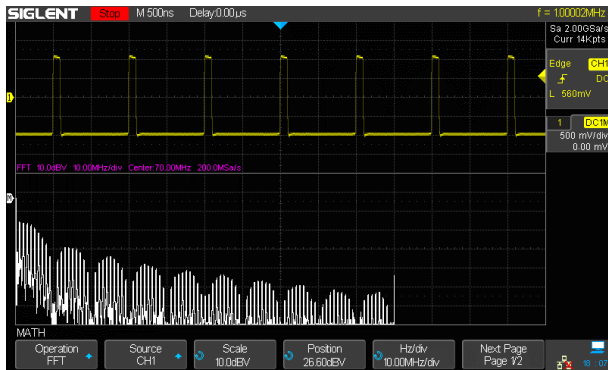

In addition to the traditional (+, -, X, /) operations, FFT, integration, differential, and square root operations are supported. The integration operation supports gating, which uses cursors to define the domain of integration

• 16 Digital Channels / MSO (Optional)

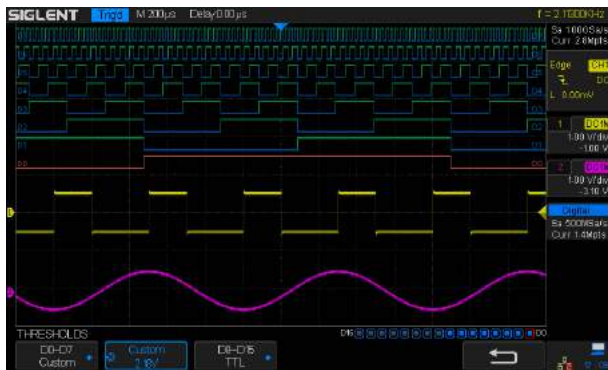

4 analog channels plus 16 digital channels enables users to acquire and trigger on the waveforms then analyze the pattern, simultaneously with one instrument.

• Built-in 25 MHz Function/Arbitrary Waveform Generator (Optional)

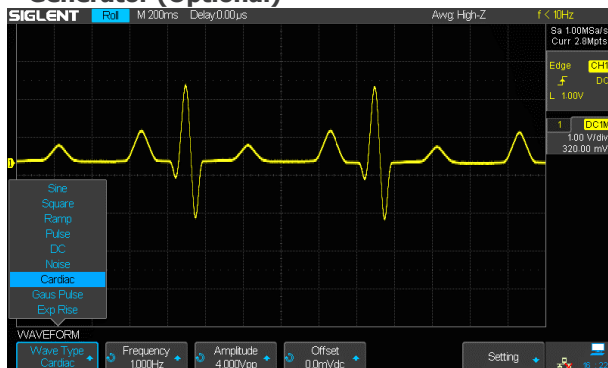

10 built-in waveforms plus 4 ARBs. The arbitrary waveforms can be accessed and edited by the EasyWave PC software

• Eres Mode

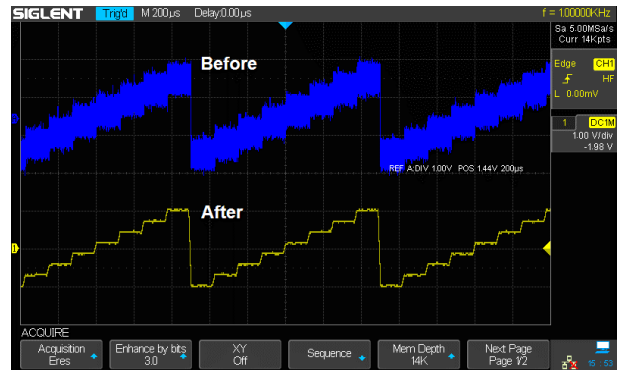

Eres mode can improve the SNR effectively, without the dependence on the periodicity of signal and stable triggering

• Serial Bus Decoding Function (Optional)

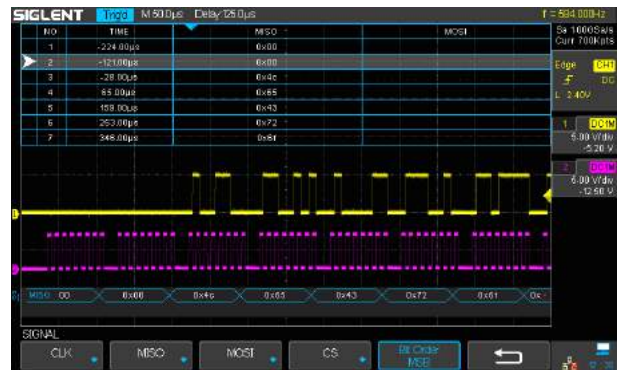

Displays the decoding through the events list. Bus protocol information can be quickly and intuitively displayed in table form

• Complete Connectivity



USB Host, USB Device (USBTMC), LAN(VXI-11), Pass/Fail and Trigger Out

Specifications

Model	SDS2072X (2CH) SDS2074X (4CH)	SDS2102X (2CH) SDS2104X (4CH)	SDS2202X (2CH) SDS2204X (4CH)	SDS2302X (2CH) SDS2304X (4CH)
Bandwidth	70 MHz	100 MHz	200 MHz	300 MHz
Sampling Rate (Max.)	2 GSa/s			
Channels	2 + EXT 4 + EXT			
Memory Depth (Max.)	140 Mpts (Single-Channel), 70 Mpts (Dual-Channel)			
Waveform Capture Rate (Max.)	140,000 wfm/s (normal mode), 500,000 wfm/s (sequence mode)			
Trigger Type	Edge, Slope, Pulse width, Window, Runt, Interval, Dropout, Pattern, Video			
Serial Trigger	IIC, SPI, UART/RS232, CAN, LIN			
Decoder Type (Optional)	IIC, SPI, UART/RS232, CAN, LIN			
16 Digital Channels (MSO Option)	Maximum waveform capture rate up to 500 MSa/s, Record length up to 140 Mpts/CH			
Waveform Generator (Optional)	Single channel, Max. frequency up to 25 MHz, 125 MSa/s sampling rate, 16 Kpts wave length			
I/O	USB Host, USB Device, LAN, Pass/Fail, Trigger Out			
Probe (Std)	PB470 70 MHz 1 pcs for each channel	PP510 100 MHz 1 pcs for each channel	SP2030A 300 MHz 1 pcs for each channel	SP2030A 300 MHz 1 pcs for each channel
Display	8 inch TFT LCD (800x480)			

Ordering Information

Description	Model
70 MHz, 2 CH, 2 GSa/s (Max.), 140 Mpts	SDS2072X
70 MHz, 4 CH, 2 GSa/s (Max.), 140 Mpts	SDS2074X
100 MHz, 2 CH, 2 GSa/s (Max.), 140 Mpts	SDS2102X
100 MHz, 4 CH, 2 GSa/s (Max.), 140 Mpts	SDS2104X
200 MHz, 2 CH, 2 GSa/s (Max.), 140 Mpts	SDS2202X
200 MHz, 4 CH, 2 GSa/s (Max.), 140 Mpts	SDS2204X
300 MHz, 2 CH, 2 GSa/s (Max.), 140 Mpts	SDS2302X
300 MHz, 4 CH, 2 GSa/s (Max.), 140 Mpts	SDS2304X
Standard Accessories	
USB Cable -1	
Passive Probe -4	
Power Cord -1	
CD (Including User Manual and EasyScopeX software) -1	
Quick Start -1	
Certification -1	
Certificate of Calibration -1	
Optional Accessories	
SDS-2000X-DC	IIC, SPI, UART/RS232, CAN, LIN Decoder
SDS-2000X-FG	25 MHz Function/Arbitrary Waveform Generator
SDS-2000X-PA	Power Analyze Software
SDS-2000X-16LA	16 Digital Channels (Software)
SPL2016	16 Channel Logic Probe
ISFE	Isolated Front End
STB	STB Demo Source
DF2001A	Power analysis Deskew Fixture
HPB4010	High Voltage Probe
CP4020/CP4050/CP4070/ CP4070A/CP5030/ CP5030A/CP5150/CP5500	Current Probe
DPB4080/DPB5150/ DPB5150A/DPB5700/ DPB5700A	High Voltage Differential Probe



SDS1000X / SDS1000X+ Super Phosphor Oscilloscope

Key Features

- 100 MHz, 200 MHz, bandwidth models
- Real-time sampling rate up to 1 GSa/s
- New generation of SPO technology
 - Waveform capture rate up to 60,000 wfm/s (normal mode), and 400,000 wfm/s (sequence mode)
 - Supports 256-level intensity grading and color temperature display
 - Record length up to 14 Mpts
 - Digital trigger system
- Intelligent trigger: Edge, Slope, Pulse, Window, Runt, Interval, Time out (Dropout), Pattern
- Serial bus triggering and decode, supports protocols I²C, SPI, UART/RS232, CAN, LIN
- Video trigger, supports HDTV
- Low background noise, supports 500 μ V / div to 10 V / div voltage scales
- 10 types of one-button shortcuts, supports Auto Setup, Default Setup, Cursor, Measure, Roll, History, Persistence, Clear Sweep, Zoom and Print
- Segmented acquisition (Sequence) mode, the maximum record length can be divided into 1000 segments, according to trigger conditions set by the user, with a very small dead time segment to capture qualifying event
- History waveform record (History) function, the maximum recorded waveform length is 80,000 frames
- Automatic measurement function on 37 parameters, supports statistics calculations, Gating measurement, Math measurement, History measuring, Ref measurement
- Waveform math function (FFT, addition, subtraction, multiplication, division, integration, differentiation, square root)
- High Speed hardware based Pass/ Fail function
- 16 Digital channels (MSO), Maximum waveform capture rate up to 500 MSa/s, Record length up to 14 Mpt/CH (Option for SDS1000X+ models)
- 25 MHz DDS arbitrary waveform generator, built-in 10 kinds of waveforms (Standard for SDS1000X+ Series)
- Large 8 inch TFT-LCD display with 800 * 480 resolution, Abundant interfaces: USB Host, USB Device (USBTMC), LAN (VXI-11), Pass / Fail, Trigger Out
- Supports SCPI remote control commands
- Supports Multi-language display and embedded online help



PLCs



Acquisition



Instruments



Data logger



Power



HMIs



Switches



Motion



Sensors



Converters



Keyboards



SCADA

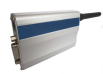

Telemetry

Characteristics

- 8 inch TFT-LCD display and 10 one-button menus



Equipped with 8" TFT-LCD display with a resolution of 800 * 480
Most commonly used functions are accessible using 10 different one-button operation keys: Auto Setup, Default Setup, Cursor, Measure, Roll, History, Persist, Clear Sweep, Zoom, Print

- Waveform capture rate up to 60,000 wfm/s

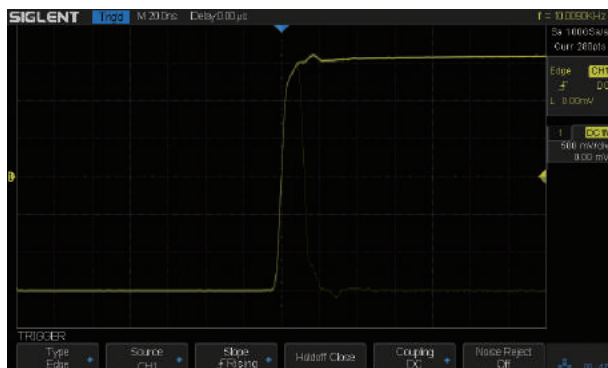

Up to 60,000 frames / second waveform capture rate, the oscilloscope can easily capture the transient events or low-probability events

- Record length of up to 14 Mpts

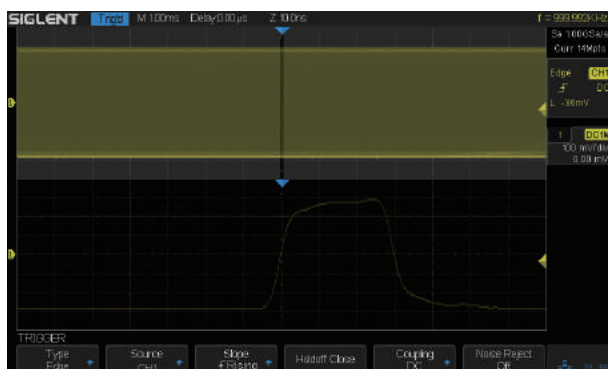

Using hardware-based Zoom technologies and record length of up to 14 Mpts, users are able to use a higher sampling rate to capture more of the signal, and then quickly zoom in to focus on the area of interest

- 16 Digital Channels/MSO (Optional for SDS1000X+)

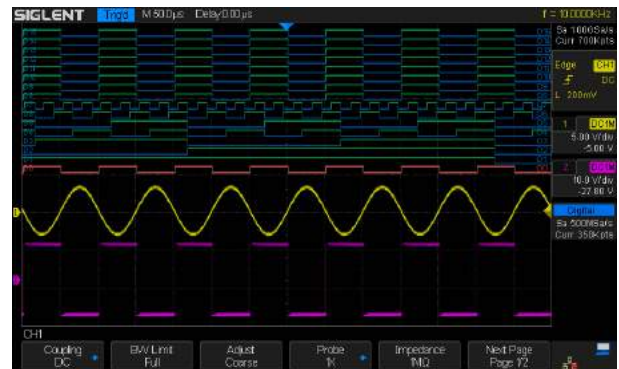

2 analog channels plus 16 digital channels enables users to acquire and trigger on the waveforms then analyze the pattern, simultaneously with one instrument.

- 256-level intensity grading and color temperature display

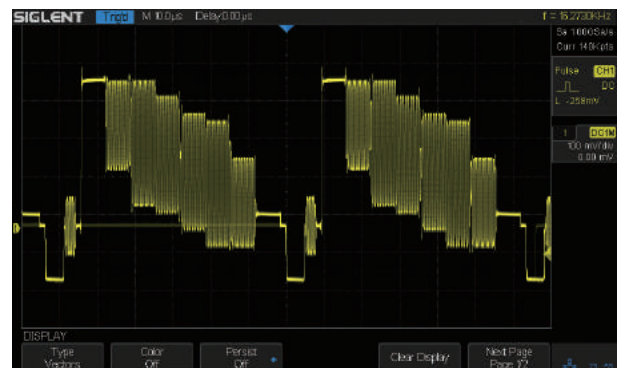

SPO display technology provides for fast refresh rates. The resulting intensity-graded trace is brighter for more often-occurring display points and dimmer in less-often-occurring points

↓ Color Temperature Display

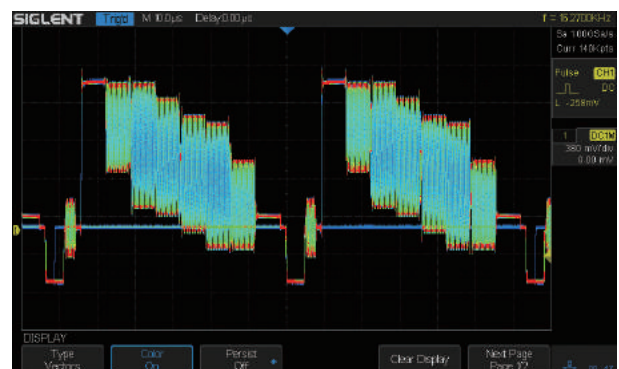

The color temperature display is similar to the intensity-graded trace except that the trace occurrence is represented by different colors (color "temperature") as opposed to changes in the intensity of one color. Red represents the most common occurrences or probabilities while blue are the least common points.

Digital Oscilloscope

Serial bus decoding Function (optional)



SDS1000X/SDS1000X+ displays the decoding through the events list. Bus protocol information can be quickly and intuitively displayed in table form

Built-in 25 MHz function/arbitrary waveform Generator (Standard for SDS1000X+ Models)

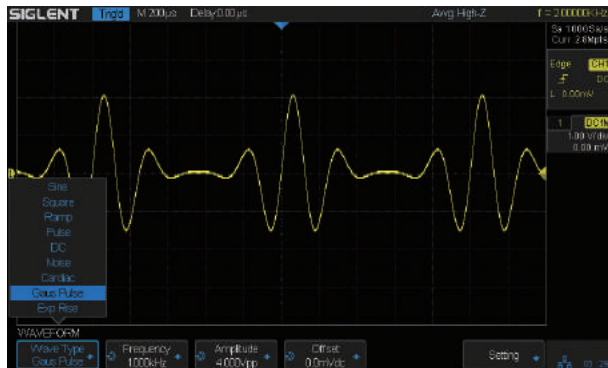

The SDS1000X+ has a built-in 25 MHz function / arbitrary waveform generator (standard), including 10 built-in waveforms plus 4 ARBs. The arbitrary waveforms can be accessed and edited by the EasyWave PC software

Advanced Math Function



In addition to the traditional (+, -, X, /) operation, SDS1000X/SDS1000X+ oscilloscopes supports FFT, integration, differentiation, and square root operations.

Comprehensive statistical functions

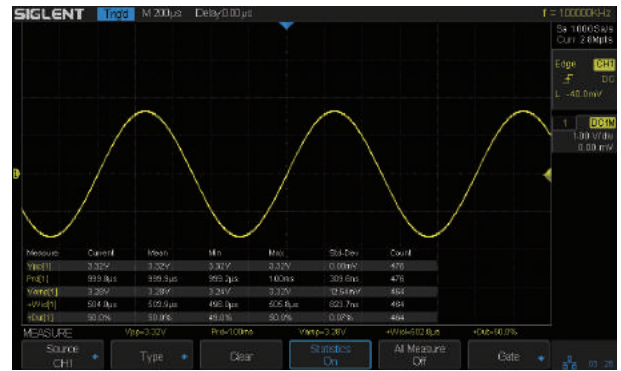

Parametric statistical functions to display any parameters of the five measurements: current, average, Minimum value, Maximum value, and the standard deviation. The measurement count is also displayed. The maximum number of parameters that can be measured and simultaneously analyzed statistically is five. Support Gating measurements, Math measurement, History measurement, Ref measurement.

Hardware-Based High Speed Pass/Fail Function

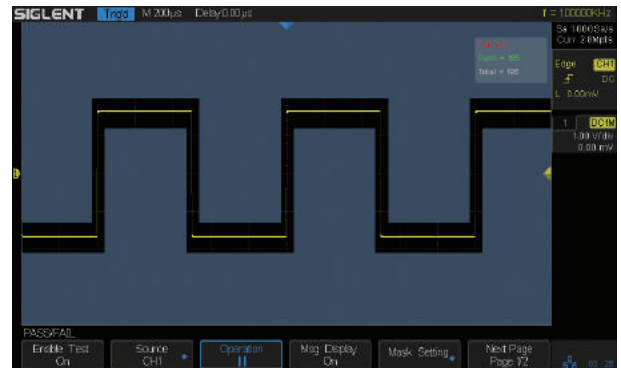

The SDS1000X/SDS1000X+ utilizes a hardware-based Pass / Fail function, performing up to 40,000 Pass / Fail decisions each second. With easy to generate user-defined test templates, the SDS1000X/SDS1000X+ compares the current measured trace to the template mask trace making it suitable for long-term signal monitoring or automated production line testing.

Complete connectivity



SDS1000X/SDS1000X+ supports USB Host, USB Device (USB-TMC), LAN (VXI-11), Pass/Fail and Trigger Out



Specifications

Model	SDS1102X	SDS1102X+	SDS1202X	SDS1202X+
Bandwidth	100 MHz		200 MHz	
Sample Rate (Max)	1 GSa/s			
Channels	2+EXT			
Memory Depth (Max)	7 Mpts/CH (Dual-Channel); 14 Mpts/CH (Single-Channel)			
Waveform Capture Rate	60,000 wfm/s (normal mode), 400,000 wfm/s (sequence mode)			
Trigger Type	Edge, Slope, Pulse width, Window, Runt, Interval, Dropout, Pattern, Video			
Serial Trigger (Optional)	I ² C, SPI, UART/RS232, CAN, LIN			
Decode Type (Optional)	I ² C, SPI, UART/RS232, CAN, LIN			
DDS Waveform Generator	No	Yes	No	Yes
	Single Channel, Max. Frequency up to 25 MHz, 125 MSa/s sampling rate, 16 Kpts wave length SDS1000X+ Supported (Standard); SDS1000X Not supported			
16 Digital Channels (MSO Option)	Maximum waveform capture rate up to 500 MSa/s, Record length up to 14 Mpts/CH SDS1000X+ Supported (Optional); SDS1000X Not supported			
Logic Probe	SPL1016 (Optional)			
I/O	USB Host, USB Device, LAN, Pass/Fail, Trigger Out, 1 KHz Cal			
Probe (Std)	2 pcs passive probe PP510		2 pcs passive probe PP215	
Display	8 inch TFT LCD (800x480)			
Weight	Net weight 3.26 Kg, Gross weight 4.25 Kg			

Ordering Information

Product Description	Product Name
100 MHz Two Channels	SDS1102X
200 MHz Two Channels	SDS1202X
100 MHz Two Channels, Built-In Waveform Generator (Standard), 16 Digital Channels (Option, *Requires SPL1016 & SDS-1000X-LA)	SDS1102X+
200 MHz Two Channels, Built-In Waveform Generator (Standard), 16 Digital Channels (Option, *Requires SPL1016 & SDS-1000X-LA)	SDS1202X+

Standard Accessories

USB Cable -1
Quick Start -1
Certificate -1
Passive Probe -2
Power Cord -1
CD (Included User Manual and EasyScopeX software) -1

Optional Accessories

I2C,SPI,UART/RS232,CAN,LIN Decode key	SDS-1000X-DC
16 Channels MSO (Software)	SDS-1000X-LA
16 Digital Channels Logic Probe	SPL1016
Isolated Front End	ISFE
STB Demo Source	STB
High Voltage Probe	HPB4010
Current Probe	CP4020/CP4050/CP4070/ CP4070A/CP5030/CP5030A/ CP5150/ CP5500
Differential Probe	DPB4080/ DPB5150/ DPB5150A/ DPB5700/ DPB5700A

Digital Oscilloscope

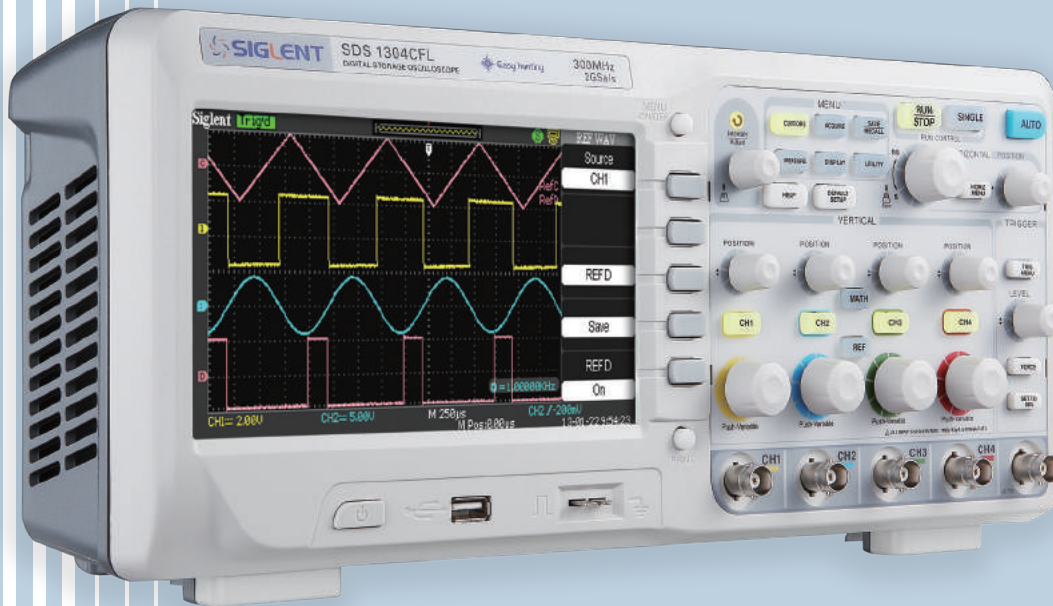

SDS1000CFL Digital Storage Oscilloscope

Application

- Embedded electronic circuit design and test
- Mechanical and electrical products design and analysis
- Education and research
- Product quality control
- Real-time signal display
- Product test, circuit function test

Key Features

- Up to 300 MHz bandwidth, 2 GSa/s real time sampling rate
- Channels: 2/4 CH + 1 EXT
- 7 inch (8*18 div) color TFT-LCD
- 6 digits hardware frequency counter, real time counting display
- Waveform record and play back function
- Unique digital filter and data recorder function
- Embedded 12 languages, online help, one key storing and one key printing
- Interface: Double USB Host, USB Device, LAN, Pass/Fail
- Support USB-TMC and VXI-11 protocol, support SCPI programming command control



PLCs



Acquisition



Instruments



Data logger



Power



HMIs



Switches



Motion



Sensors



Converters



Keyboards

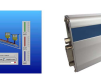

SCADA



Telemetry

Specifications

Model	SDS1074CFL (4 CH)	SDS1104CFL (4 CH)	SDS1202CFL (2 CH) SDS1204CFL (4 CH)	SDS1302CFL (2 CH) SDS1304CFL (4 CH)
Bandwidth	70 MHz	100 MHz	200 MHz	300 MHz
Channels	4 CH+1 EXT		4 CH + 1 EXT/2 CH + 1 EXT	
Real time sampling rate	2 GSa/s (half channel),1 GSa/s (each channel)			
Equivalent sampling rate	50 GSa/s			
Memory depth	24 Kpts (half channel),12 Kpts (each channel)			
Rise time	<5.0 ns	<3.5 ns	<1.7 ns	<1.2 ns
Input impedance	1 M Ω 13 pF		1 M Ω 13 pF, 50 Ω	
Time base range	5 ns/div-50 s/div Scan:100 ms-50 s/div	2.5 ns/div-50 s/div	2.5 ns/div-50 s/div	1.0 ns/div-50 s/div
Vertical sensitivity	2 mv-5 v/div(1-2-5 order)			
Vertical resolution	8 bit			
Trigger source	CH1, CH2, CH3, CH4, Ext, Ext/5, AC Line			
Trigger types	Edge, Pulse, Video, Slope, Alternative			
Math operation	+, -, *, /, FFT			
Digital filter	High pass, Low pass, Band pass, Band stop			
Max input voltage	\pm 400 V (DC+AC Pk-Pk) CATI CAT II			
Internal storage	2/4 groups of reference waveform, 20 groups of settings,20 groups of waveforms			
External storage	Bitmap save, CSV save, Waveform save, Setting save			
Language	English, French, German, Russian, Spanish, Simplified Chinese, Traditional Chinese, Portuguese, Japanese, Korean, Italian, Arabic			
Interface	Double USB Host, USB Device, LAN, Pass/Fail			
Display	7 inch color TFT- LCD			

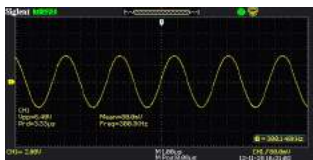

8x18 div widescreen

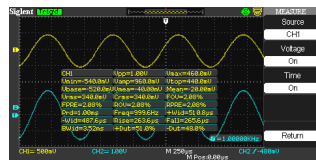

32 types of auto measurements

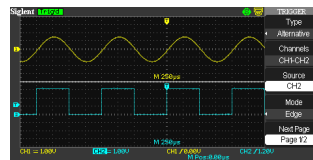

Alternative-trigger

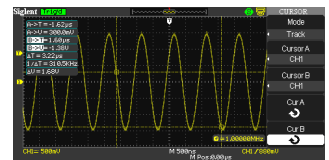

Cursor-measurement

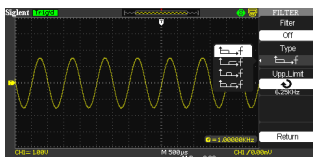

Digital-filter

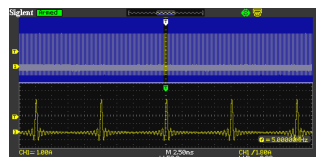

Onekey Zoom-1

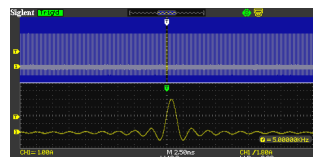

Onekey Zoom-2

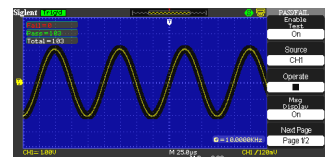

Pass-fail

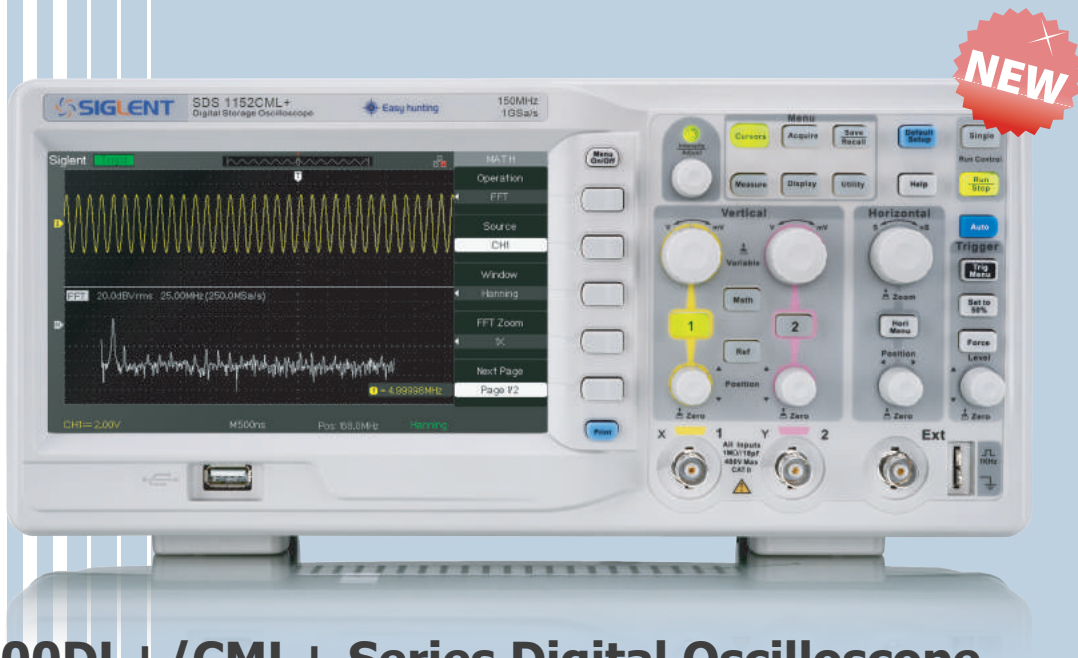

SDS1000DL+ /CML+ Series Digital Oscilloscope

Application

- Electronic circuit design and debugging
- Electrical circuit function test
- Inspect instantaneous signal
- Industrial control and measuring
- Products quality control
- Education and training

Key Features

- 50 MHz to 150 MHz Bandwidth
- 500 MSa/s~1 GSa/s sampling rate, 32 Kpts~2 Mpts memory depth
- 7 inch (8*18 div) color TFT-LCD display
- 6 digits hardware frequency counter, real time counting display
- Waveform record and play back function
- Unique digital filter and data recorder function
- Embedded 12 languages, online help, one key storing and one key printing
- Interface: USB Device, USB Host, RS-232, Pass/Fail
- Supports USB-TMC protocol and SCPI programming command control

Specifications

Model	SDS1052DL+	SDS1072CML+	SDS1102CML+	SDS1152CML+
Bandwidth	50 MHz	70 MHz	100 MHz	150 MHz
Channels	2 CH +1 EXT			
Real time sampling rate	500 MSA/s	1 GSA/s	1 GSA/s	1 GSA/s
Equivalent sampling rate	50 GSA/s			
Memory depth	32 Kpts	2 Mpts	2 Mpts	2 Mpts
Input impedance	1 MΩ 17 pF	1 MΩ 17 pF	1 MΩ 17 pF	1 MΩ 17 pF
Vertical sensitivity	2 mv~10 v/div	2 mv~10 v/div	2 mv~10 v/div	2 mv~10 v/div
Vertical resolution	8 bit			
Trigger source	CH1, CH2, Ext, Ext/5, AC Line			
Trigger types	Edge, Pulse, Video, Slope, Alternative			
Math operation	+, -, *, /, FFT			
Digital filter	High pass, Low pass, Band pass, Band stop			
Data recorder function	√	√	√	√
Max input voltage	± 400 V (DC+AC Pk-Pk) CAT I CAT II			
Internal storage	2 groups of reference waveform, 20 groups of setting,10 groups of waveform			
External storage	Bitmap save, CSV save, Waveform save, Setting save			
Lasting	Turn off, 1 s, 2 s, 5 s, infinite			
Language	English, French, German, Russian, Spanish, SimplifiedChinese, TraditionalChinese, Portuguese, Japanese, Korean, Italian, Arabic			
Interface	USB Host, USB Device, RS-232, Pass/Fail			
Display	7 inch color TFT-LCD			
Power	AC 100-240 V, 45 Hz-440 Hz, 50 VA Max			

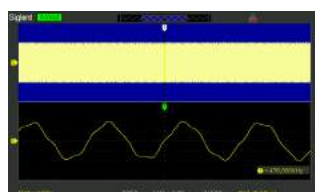

Normal Memory (40 Kpts)

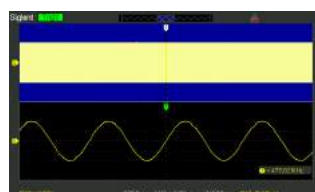

Long Memory (2 Mpts)



32 types of auto measurements



5 parameters display

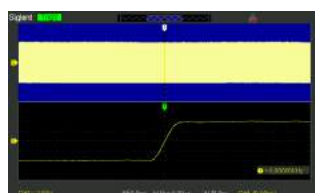

Zoom Function

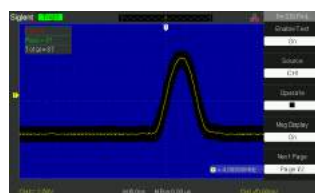

Pass/Fail Function



Math Function



Embedded Online Help

Standard Accessories

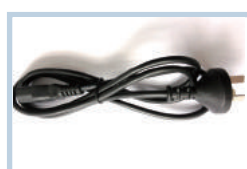

SDG5000 Function/Arbitrary Waveform Generator



Application

- IC test
- Simulate sensor
- Simulate environment signals
- Electrical circuit function test
- Education and training

Key Features

- DDS technology, double channels output, phase adjustable
- Output frequency up to 160 MHz, 500 MSa/s sampling rate, 14 bit vertical resolution, 512 Kpts max wave length
- 2 ppm high frequency stability, -116 dBc/Hz low phase noise
- Abundant modulation functions, sweep-frequency output, burst output
- Built-in high precision frequency counter, frequency range: 100 mHz - 200 MHz
- Unique EasyPulse technology, can output the pulse signal which have low jitter, fast rising and falling edge, very small duty cycle. Edge and pulse width can be a wide range of adjustment.
- Seamless work with siglent Digital Storage Oscilloscope
- Supports USB-TMC protocol and SCPI programming command control

Specifications

Model	SDG5162
Maximum output frequency	160 MHz
Output channels	2
Sampling rate	500 MSa/s
Wave length	CH1:16 Kpts,CH2:512 Kpts
Frequency resolution	1 μ Hz
Vertical resolution	14 bit
Waveform	Sine, Square, Ramp, Pulse, Gaussian white noise, Arb
Modulation function	AM, DSB-AM, FM, PM, FSK, ASK, PWM, Sweep, Burst
Amplitude	CH1/CH2 \leq 40 MHz: 1 mVpp \sim 10 Vpp (50 Ω), 2 mVpp \sim 20 Vpp (high impedance) 40 MHz \sim 100 MHz: 1 mVpp \sim 5 Vpp (50 Ω), 2 mVpp \sim 10 Vpp (high impedance) 100 MHz \sim 160 MHz: 1 mVpp \sim 1.5 Vpp (50 Ω), 2 mVpp \sim 3 Vpp (high impedance)
Frequency counter	Frequency range: 100 MHz \sim 200 MHz
Interface	USB Host, USB Device
Optional interface	USB-GPIB Adapter
Dimension	261 mm*104.85 mm*343.8 mm

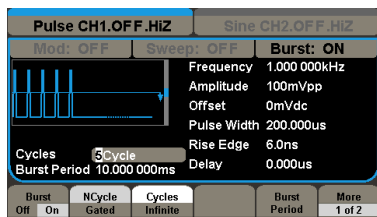

Burst

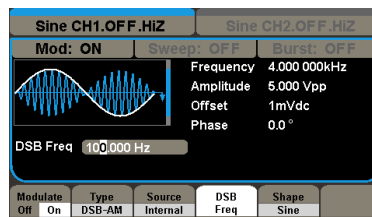

DSB-AM

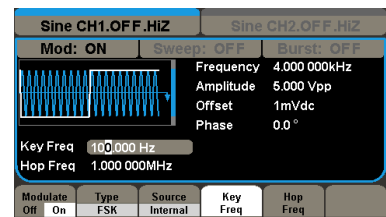

FSK

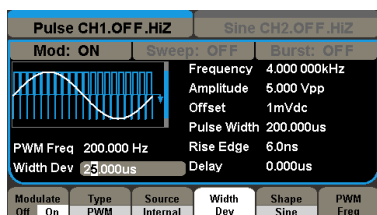

PWM

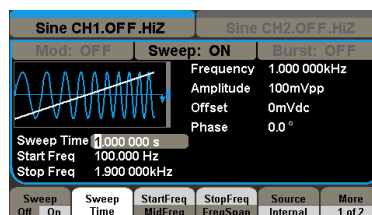

Sweep

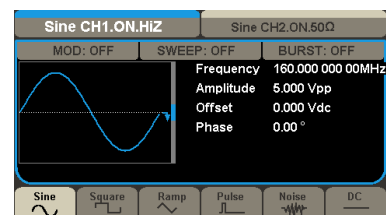

Up to 160 MHz

SDG2000X Series Function/Arbitrary Waveform Generator



Key Features

- Dual-channel, 120 MHz maximum bandwidth, 20 Vpp maximum output amplitude, high fidelity output with 80 dB dynamic range
- High-performance sampling system with 1.2 GSa/s sampling rate and 16-bit vertical resolution. No detail in the waveforms will be lost
- Innovative TrueArb technology, based on a point-by-point architecture, supports any 8 pts~8 Mpts Arb waveform with a sampling rate in range of 1 μ Sa/s~75 MSa/s
- Innovative EasyPulse technology, capable of generating lower jitter Square or Pulse waveforms, brings a wide range and extremely high precision in pulse width and rise/fall times adjustment
- Plenty of analog and digital modulation types: AM、DSB-AM、FM、PM、PSK、FSK、ASK and PWM
- Practical functions: Channel Copy, Channel Coupling, Channel Track, harmonic generator, overvoltage protection function
- Sweep and Burst function, Harmonics mode supported
- High precision Frequency Counter
- Standard interfaces: USB Host, USB Device (USBTMC) , LAN (VXI-11)
- Optional interface: USB-GPIB
- 4.3" touch screen display for easier operation



PLCs



Acquisition



Instruments



Data logger



Power



HMI's



Switches



Motion



Sensors



Converters



Keyboards

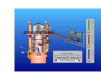

SCADA

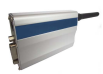

Telemetry

Characteristics

- Excellent Analog Channel Performance

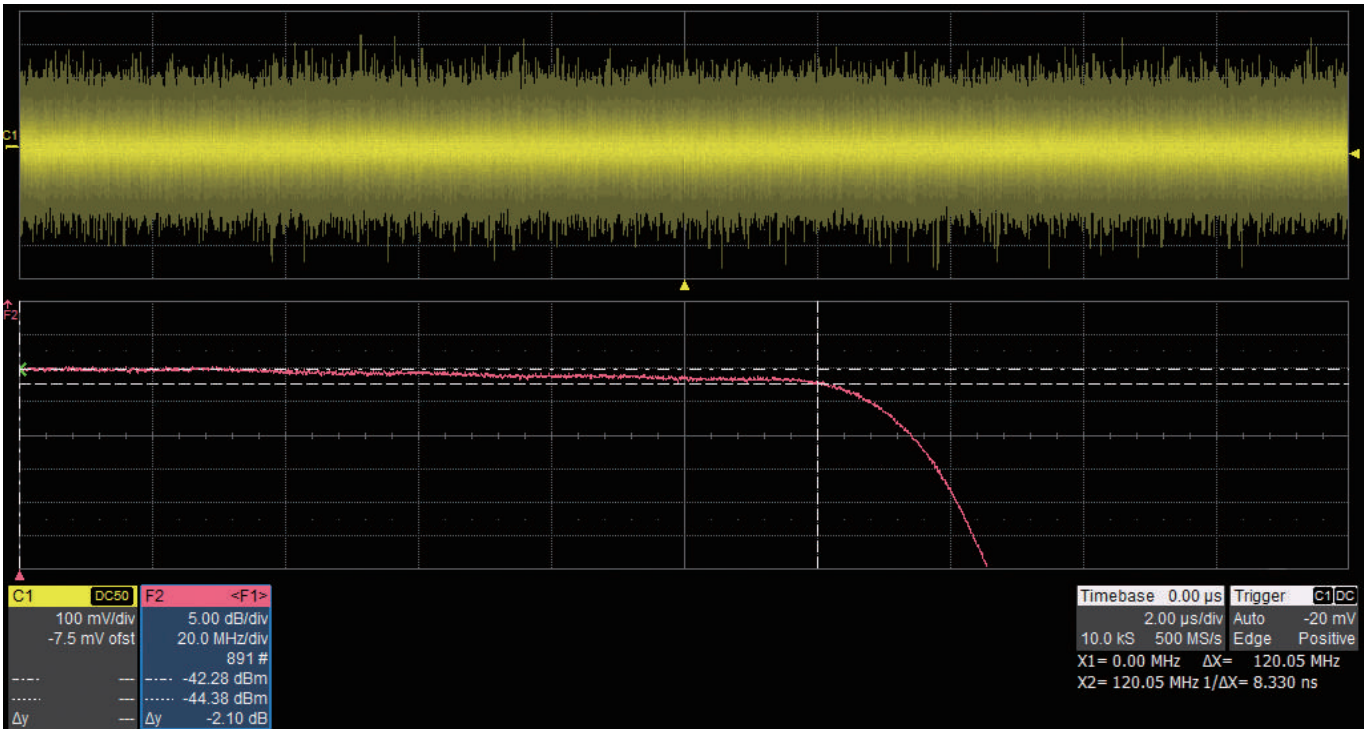

▲ The bandwidth of analog channels proves to be greater than 120 MHz, via doing a frequency response test with white noise.

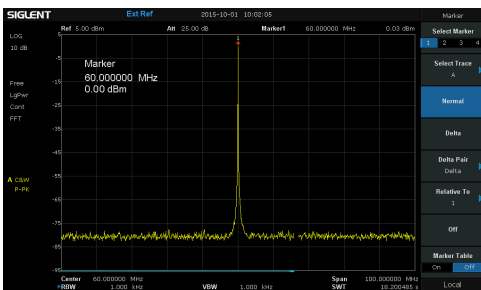

◀ High fidelity sine output. Almost no spurious observed @60 MHz, 0 dBm.

▶ Capacity of outputting large signal at high frequency. Dual-channel, 20 Vpp amplitude can be guaranteed even @20 MHz.

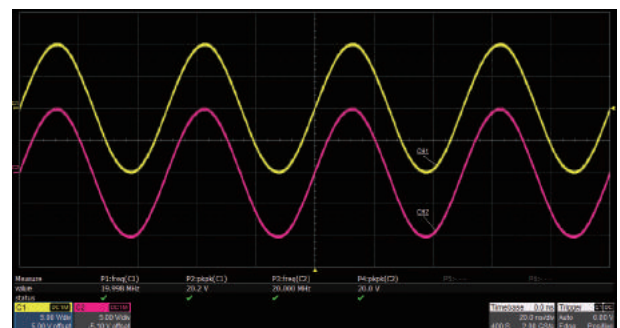

▶ Low noise floor, improves signal-noise ratio.



Waveform Generator

• Innovative EasyPulse Technology

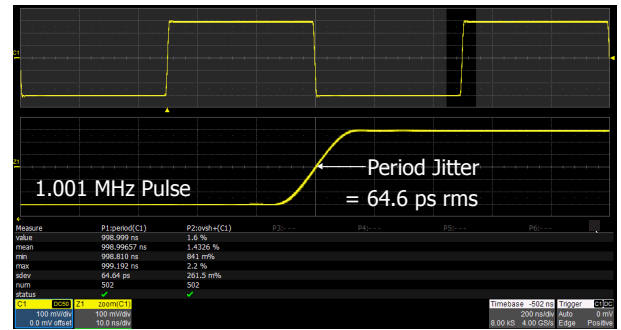

When a Square/Pulse waveform is generated by DDS, there will be a one-clock-jitter if the sampling rate is not an integer-related multiple of the output frequency. SDG2000X EasyPulse technology successfully overcomes this weakness in DDS designs and helps to produce low jitter Square/Pulse waveforms.

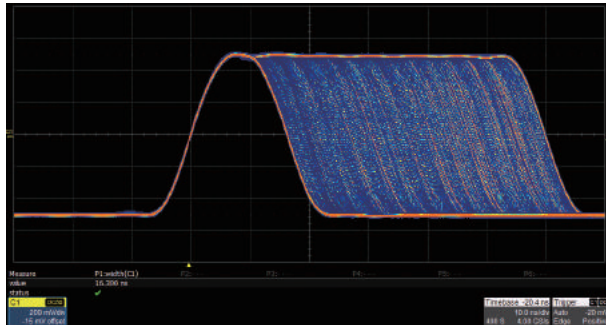

The Pulse width can be fine-tuned to the minimum of 16.3 ns with the adjustment step as small as 100 ps.

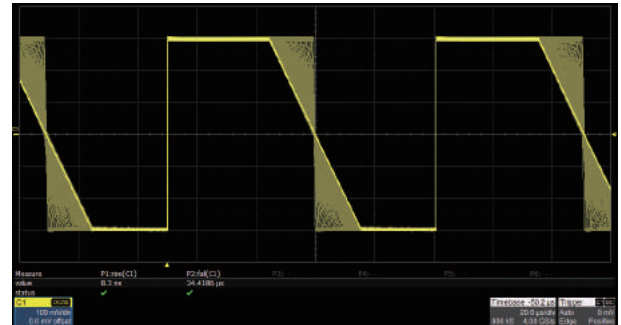

The rise/fall times can be set independently to the minimum of 8.4 ns at any frequency and to the maximum of 22.4 s. The adjustment step is as small as 100 ps.

• Innovative TrueArb Technology

For arbitrary waveforms, TrueArb not only has all the advantages of traditional DDS, but also eliminates the probability that DDS may cause serious jitter and distortion.

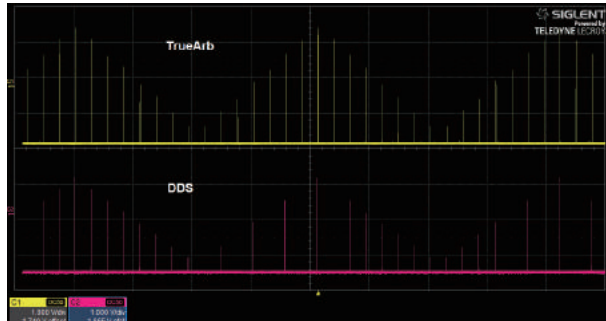

TrueArb generates arbitrary waveforms point by point, never skips any point so that it can reconstruct all the details of the waveform as defined.

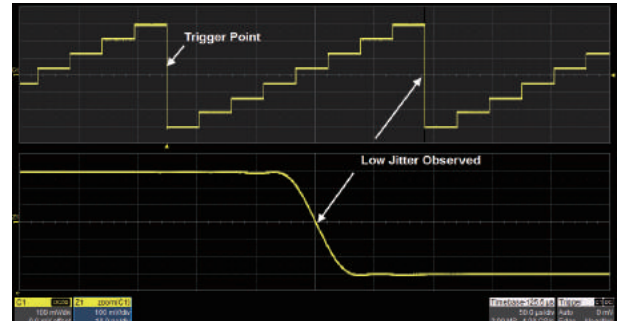

As with EasyPulse, TrueArb effectively overcomes the defect that DDS may cause the one-clock-jitter in arbitrary waveforms.

• 4.3" Touch Screen Display

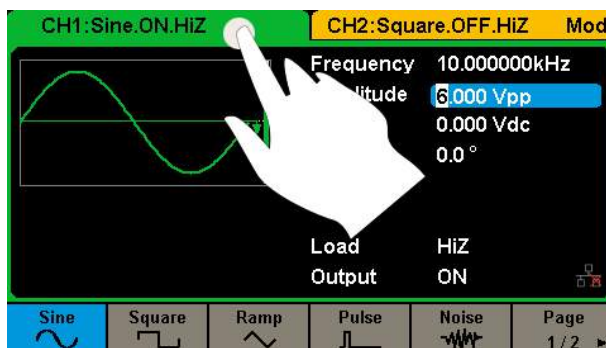

4.3" touch screen display, makes operation much more convenient.

• Arbitrary Waveform Software EasyWave

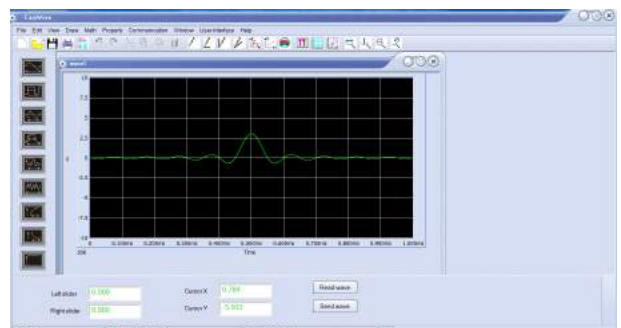

EasyWave is a powerful arbitrary waveform editing software that supports several ways to generate arbitrary waveform such as manual drawing, line-drawing, equation-drawing, coordinate-drawing, etc. It is quite convenient for users to edit their own arbitrary waveforms through EasyWave.

Characteristics

• High-performance Sampling System

Benefiting from a 1.2 GSa/s and 16-bit sampling system, SDG2000X achieves extremely high accuracy performance in both time domain and amplitude, which results in more accurately reconstructed waveforms and lower distortion.

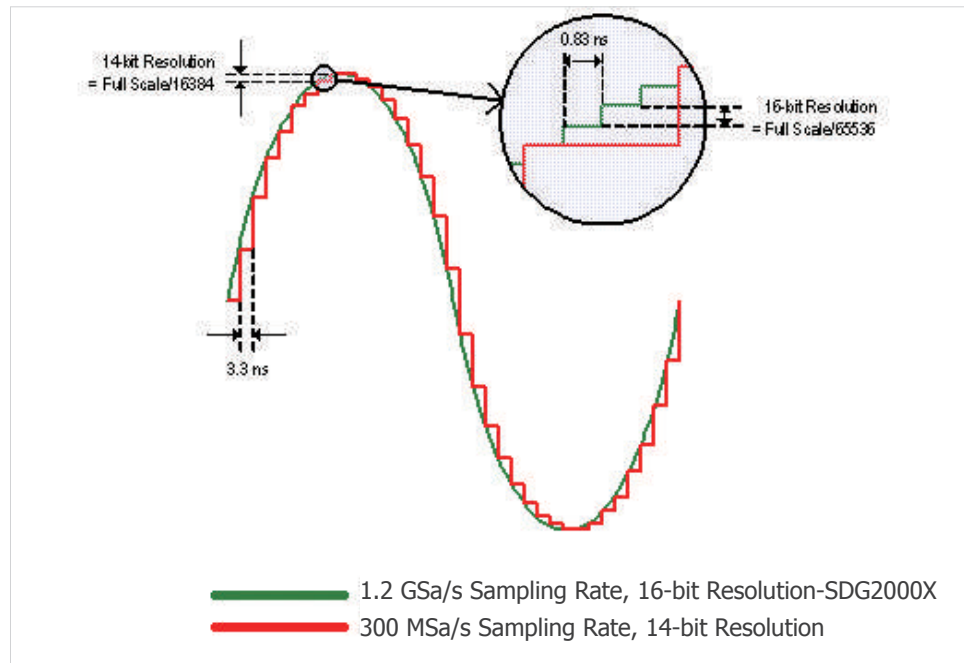

Specifications

Product Model	SDG2042X	SDG2082X	SDG2122X
Bandwidth	40 MHz	80 MHz	120 MHz
Sampling rate	1.2 GSa/s (4 X Interpolation)		
Vertical resolution	16 bit		
Num. of channels	2		
Max. amplitude	±10 V		
Display	4.3" touch screen display, 480 x 272 x RGB		
Interface	Standard: USB Host, USB Device, LAN Optional: GPIB (USB-GPIB adaptor)		

Frequency Characteristics

Parameter	Min.	Typ.	Max.	Unit	Condition
Resolution			1 μ	Hz	
Initial accuracy	-1		+1	ppm	25°C
	-2		+2	ppm	0~40°C
1 st -year aging	-1		+1	ppm	25°C
10-year aging	-3.5		+3.5	ppm	25°C

Sine Characteristics

Parameter	Min.	Typ.	Max.	Unit	Condition
Frequency	1 μ		120 M	Hz	
Harmonic distortion			-65	dBc	0 dBm, 0~10 MHz (Included)
			-60	dBc	0 dBm, 10~20 MHz (Included)
			-55	dBc	0 dBm, 20~40 MHz (Included)
			-50	dBc	0 dBm, 40~60 MHz (Included)
			-45	dBc	0 dBm, 60~80 MHz (Included)
			-40	dBc	0 dBm, 80~100 MHz (Included)
			-38	dBc	0 dBm, 100~120 MHz (Included)
Total Harmonic Distortion			0.075	%	0 dBm, 10 Hz ~ 20 kHz
Non-harmonic spurious			-70	dBc	≤50 MHz
			-65	dBc	>50 MHz

Waveform Generator

Square Characteristics					
Parameter	Min.	Typ.	Max.	Unit	Condition
Frequency	1 μ		25 M	Hz	
Rise/fall times			9	ns	10% ~ 90%, 1 Vpp, 50 Ω Load
Overshoot			3	%	100 kHz, 1 Vpp, 50 Ω Load
Duty cycle	0.001		99.999	%	Limited by frequency setting
Jitter (rms), Cycle to cycle			150	ps	1 Vpp, 50 Ω Load

Pulse Characteristics					
Parameter	Min.	Typ.	Max.	Unit	Condition
Frequency	1 μ		25 M	Hz	
Pulse width	16.3			ns	
Pulse width accuracy			$\pm(0.01\%+0.3 \text{ ns})$		
Rise/fall times	8.4 n		22.4	s	10% ~ 90%, 1 Vpp, 50 Ω Load, Subject to pulse width limits
Overshoot			3	%	100 kHz, 1 Vpp
Duty cycle	0.001		99.999	%	Limited by frequency setting
Duty cycle resolution	0.001			%	
Jitter (rms) cycle to cycle			150	ps	1 Vpp, 50 Ω Load

Arbitrary Wave characteristics					
Parameter	Min.	Typ.	Max.	Unit	Condition
Frequency	1 μ		20 M	Hz	
Waveform length	8		8 M	pts	
Sampling rate	1 μ		75 M	Sa/s	TrueArb mode
	300			MSa/s	DDS mode
Vertical solution	16			bit	
jitter (rms)			150	ps	1 Vpp, 50 Ω Load, TrueArb mode

Output Characteristics					
Parameter	Min.	Typ.	Max.	Unit	Condition
Range (Note 1)	2 m		20	Vpp	≤ 20 MHz, HiZ load
	2 m		10	Vpp	> 20 MHz, HiZ load
	1 m		10	vpp	≤ 20 MHz, 50 Ω load
	1 m		5	vpp	> 20 MHz, 50 Ω load
Accuracy	$\pm (1\%+1 \text{ mVpp})$				10 kHz sine, 0 V offset
Amplitude flatness	-0.3		+0.3	dB	0~100 MHz (Included), 50 Ω load, 2.5 Vpp, compare to 10 kHz Sine
	-0.4		+0.4	dB	100~120 MHz (Included), 50 Ω load, 2.5 Vpp, compare to 10 kHz Sine
Output impedance	49.5	50	50.5	Ω	10 kHz sine
Output current	-200		200	mA	
Crosstalk			-60	dBc	CH1 - CH2/CH2 - CH1

Note 1: The specification will be divided by 2 while applied to a 50 Ω load.

Ordering Information

Product Description	SDG2000X Series Function/Arbitrary Waveform Generator
Product code	SDG2042X 40 MHz
	SDG2082X 80 MHz
	SDG2122X 120 MHz
Standard configurations	A Quick Start, A Quality Certification, A Power Cord, A USB Cable, A CD (Including Quick Start, data sheet, and Application Software Package), A Calibration Certificate, A BNC Coaxial Cable
Optional configurations	USB-GPIB adapter

SDG1000X Function/Arbitrary Waveform Generator



Application

- IC test
- Simulate sensor
- Simulate environment signals
- Electrical circuit function test
- Education and training

Key Features

- Dual-channel, with bandwidth up to 60 MHz, and amplitude up to 20 Vpp
- 150 MSa/s sampling rate, 14-bit vertical resolution, and 16 kpts waveform length
- Innovative EasyPulse technology, capable of generating lower jitter Pulse waveforms, brings a wide range and extremely high precision in pulse width and rise/fall times adjustment
- Special circuit for Square wave function, can generate Square waves up to 60 MHz with jitter less than 300 ps+0.05 ppm of period
- Plenty of analog and digital modulation types: AM, DSB-AM, FM, PM, FSK, ASK, PSK and PWM
- Sweep and Burst functions
- Harmonics Generator function
- Waveform Combining function
- High precision Frequency Counter
- Standard interfaces: USB Host, USB Device (USBTMC), LAN (VXI-11)
- Optional interface: GPIB
- 4.3" TFT-LCD display



Waveform Generator

Models and Key Specifications

Product Model	SDG1032X	SDG1062X
Bandwidth	30 MHz	60 MHz
Sampling rate	150 MSa/s	
Vertical resolution	14-bit	
Waveform Length	16 kpts	
Num. of channels	2	
Max. amplitude	±10 V	
Display	4.3" display, 480 x 272 x RGB	
Interface	Standard: USB Host, USB Device, LAN Optional: GPIB (USB-GPIB adaptor)	

Characteristics

• Identical dual output-channels with high performance

Capable of outputting large signals at high frequencies. dual-channels, 20 Vpp amplitude can be guaranteed at up to 10 MHz.

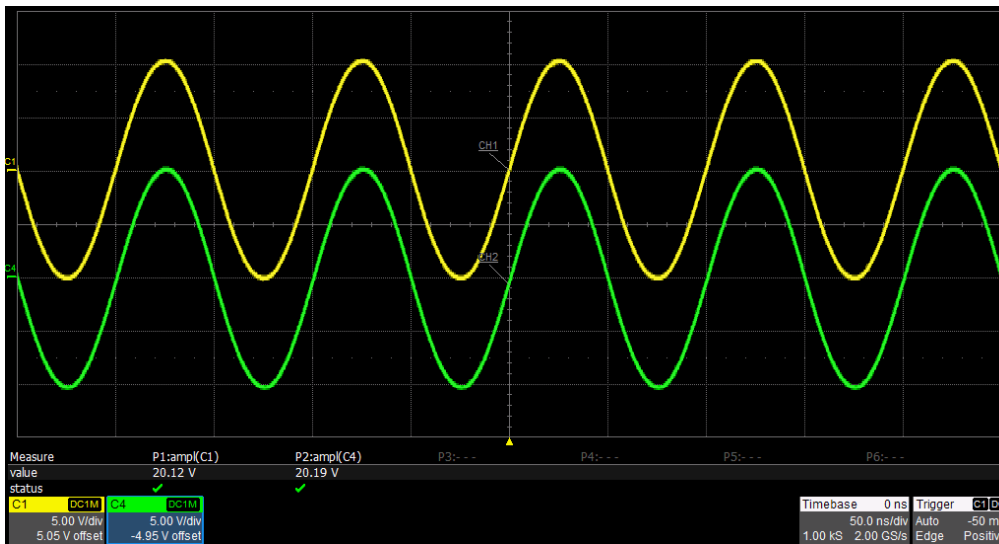

• Low Distortion Output

With 0 dBm output, the THD (Total Harmonic Distortion) is less than 0.075%. Harmonics and spurs are less than -40 dBc throughout the entire bandwidth.

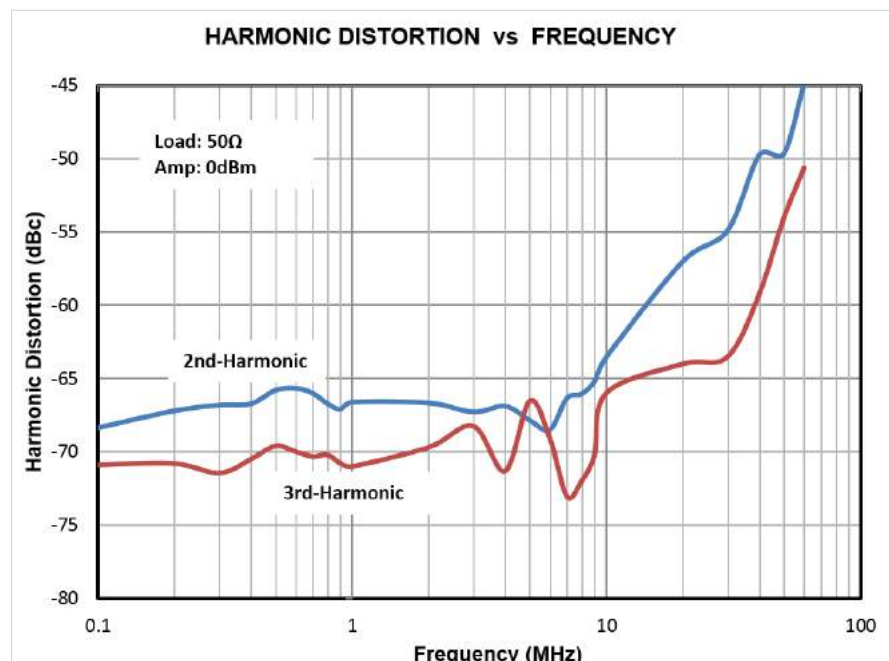

• Innovative EasyPulse Technology

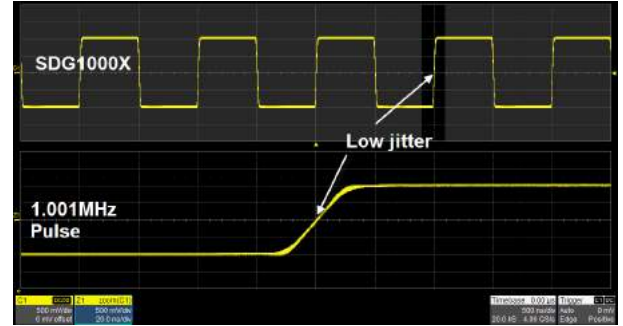
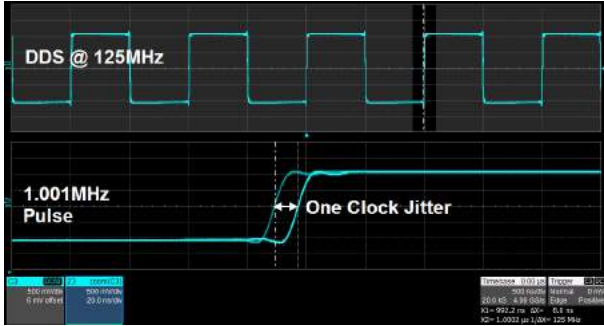

When a Pulse waveform is generated by a common DDS generator, there will be a one-clock-jitter if the sampling rate is not an integer-related multiple of the output frequency. SDG1000X EasyPulse technology successfully overcomes this weakness in DDS designs and helps to produce low jitter Pulse waveforms.

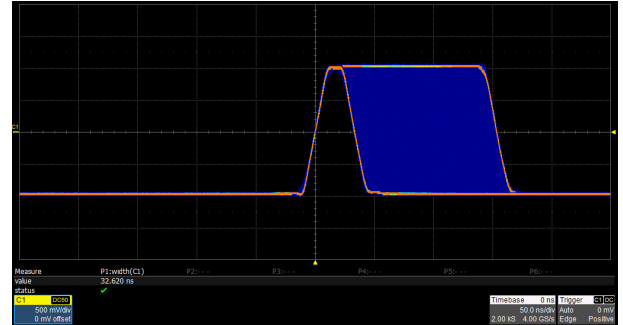
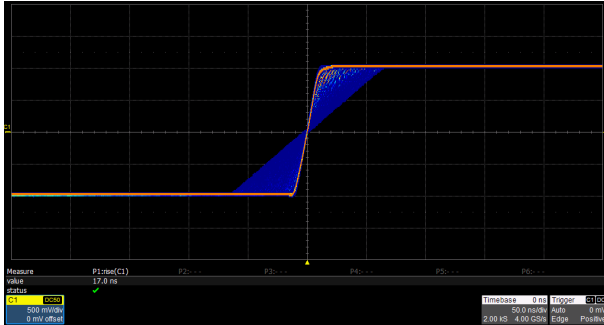

The rise/fall times can be set independently to the minimum of 16.8 ns at any frequency and to the maximum of 22.4 s. The adjustment step is as small as 100 ps. The Pulse width can be fine-tuned to the minimum of 32.6 ns with the adjustment step as small as 100 ps.

• High performance Square Waves

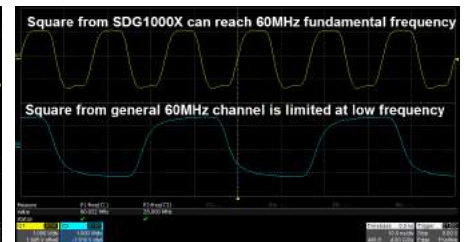
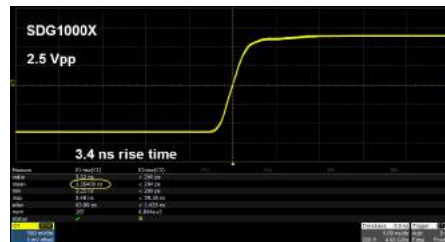

Benefiting from a special square-wave generating circuitry, the Square from the SDG1000X breaks the 60 MHz bandwidth barrier, reaching rise/fall times of less than 4.2 ns, and frequencies up to 60 MHz.

► The Square wave exhibits the same excellent jitter performance as the Pulse waveform.

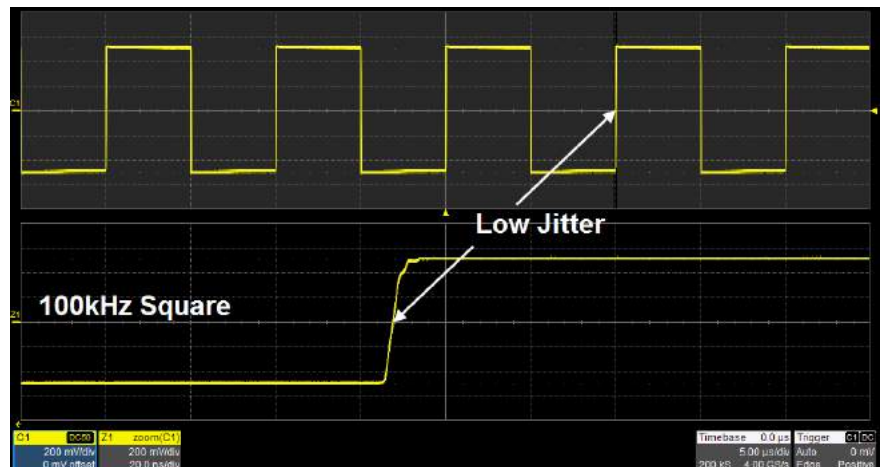

Characteristics

• Modulation

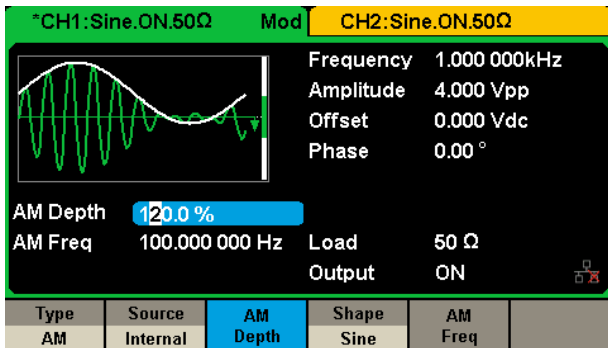

Multiple modulation types: AM, DSB-AM, FM, PM, FSK, ASK, PSK and PWM. The modulation source can be configured as "Internal" or "External".

• Harmonics Function

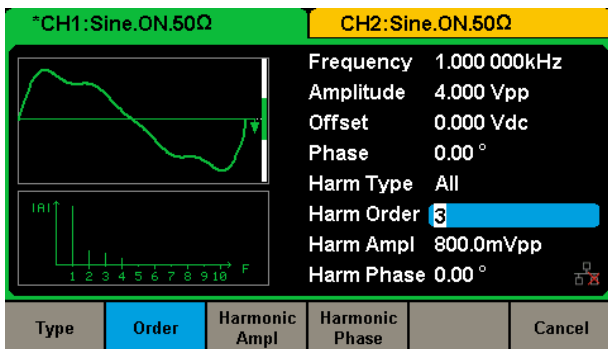

Up to 10 harmonics may be generated. Amplitude and phase of each harmonic can be set independently

• Frequency Counter

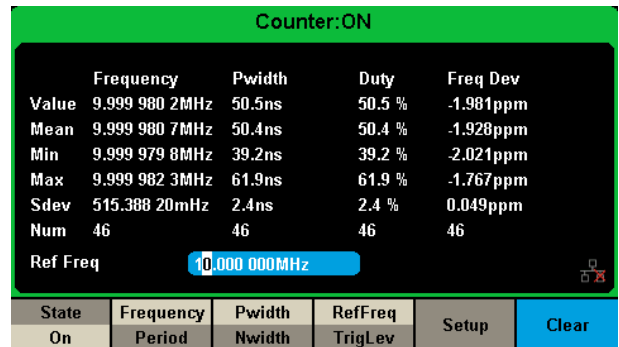

High precision Frequency Counter with an input frequency range of 0.1 Hz~200 MHz.

• Waveform Combining

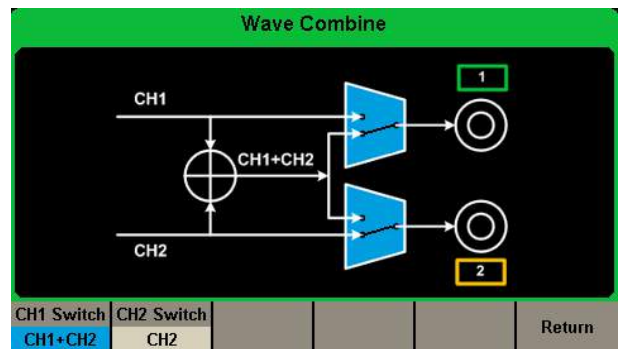

Capable of combining the waveforms of 2 channels from internal, providing more flexible tools to generate complex waveforms.

Ordering Information

Product Description	
30 MHz, 2 CH, 150 MSa/s, 14 bit	SDG1032X
60 MHz, 2 CH, 150 MSa/s, 14 bit	SDG1062X
Standard configurations	
Quick Start -1	
Product Certification -1	
Power Cord-1	
Calibration Certificate -1	
USB Cable -1	
CD (Includes Quick Start guide, data sheet, and Application Software Package) -1	
Optional configurations	
BNC Coaxial Cable	SDG-BNC
20 dB Attenuator	ATT-20dB
USB-GPIB Adapter	USB-GPIB

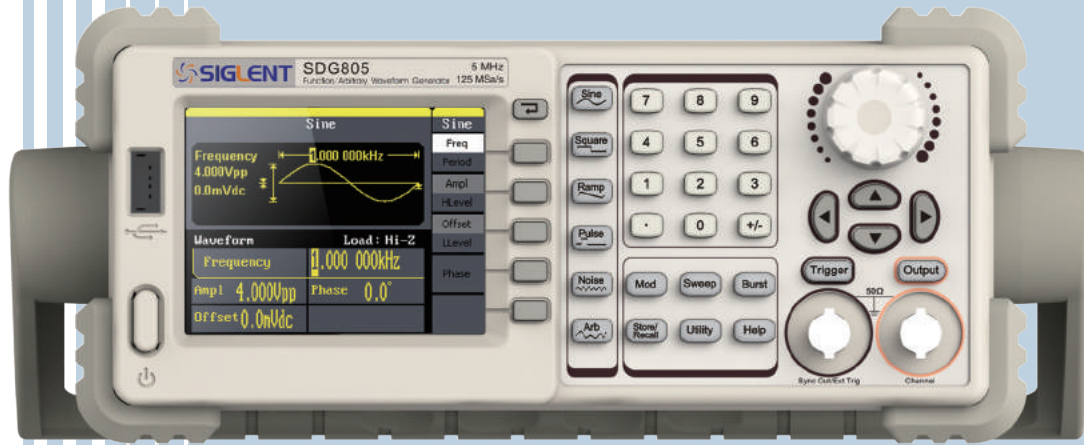

SDG800 Function/Arbitrary Waveform Generator

Application

- Simulate sensor
- Simulate environmental signal
- Circuit function test
- IC chip test
- Research and education

Key Features

- Advanced DDS technology, 125 MSa/s sampling rate, 14 bit vertical resolution
- Single channel output, 5 kinds of standard waveforms, built-in 46 kinds of arbitrary waveforms (including DC)
- Complete modulation functions: AM, DSB-AM, FM, PM, FSK, ASK, PWM, linear/logarithmic sweep and burst
- Innovative EasyPulse technology, can output pulse of low jitter, quick rising/falling edge
- Standard interfaces: USB Device, USB Host, support U-Disk storage and software update
- Provide 10 nonvolatile storage spaces for user's arbitrary waveforms
- Be capable of seamlessly connected to SIGLENT Digital Storage Oscilloscope
- Configurable with powerful arbitrary waveform editing software EasyWave



PLCs



Acquisition



Instruments



Data logger



Power



HMIs



Switches



Motion



Sensors



Converters



Keyboards



SCADA

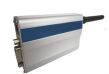

Telemetry

Waveform Generator

Specifications

Model	SDG805	SDG810	SDG830
Maximum output frequency	5 MHz	10 MHz	30 MHz
Output channels	1		
Sampling rate	125 MSa/s		
Wave length	16 kpts		
Frequency resolution	1 μ Hz		
Vertical resolution	14 bit		
Waveform	Sine, Square, Ramp, Pulse, Gaussian white noise, Arbitrary waveform, 46 types of built-in arbitrary waveforms		
Sine wave	1 μ Hz ~ 5 MHz	1 μ Hz ~ 10 MHz	1 μ Hz ~30 MHz
Square wave	1 μ Hz ~ 5 MHz	1 μ Hz ~ 10 MHz	1 μ Hz ~10 MHz
Pulse	500 μ Hz ~ 5 MHz	500 μ Hz ~ 5 MHz	500 μ Hz ~5 MHz
Ramp/Triangular	1 μ Hz ~ 300 KHz	1 μ Hz ~ 300 KHz	1 μ Hz ~ 300 KHz
Gaussian white noise	>5 MHz bandwidth (-3 dB)	>10 MHz bandwidth (-3 dB)	>30 MHz bandwidth (-3 dB)
Arbitrary waveform	1 μ Hz ~ 5 MHz	1 μ Hz ~ 5 MHz	1 μ Hz ~ 5 MHz
Modulation function	AM, FM, PM, DSB-AM, FSK, ASK, PWM, Sweep, Burst		
Standard configuration	USB Host & USB Device		
Amplitude (high impedance)	4 mVpp~20 Vpp (\leq 10 MHz) 4 mVpp~10 Vpp ($>$ 10 MHz)		

SPD3303 Programmable Linear DC Power Supply



Application

- R&D lab general purpose testing
- Teaching lab experiment
- Automotive electronic test
- Production testing and quality assessment inspection

Key Features (SPD3303X/SPD3303X-E)

- 3 independent controlled and isolated output, 32 V/3.2 A×2, 2.5 V/3.3 V/5 V/3.2 A×1, total 220 W
- Max 5 digits Voltage, 4 digits Current Display, Minimum Resolution: 1 mV/1 mA
- Supports panel timing output functions
- 4.3 inch true color TFT- LCD 480x272 display
- 3 types of output modes: independent, series, parallel
- 100 V/120 V/220 V/230 V compatible design to meet the needs of different power grids.
- Intelligent temperature-controlled fan , effectively reducing noise
- Clear graphical interface, with the waveform display function
- Internal 5 groups of system parameter save/recall, supports data storage space expansion
- Provides PC software: EasyPower , supports SCPI , LabView driver

Key Features (SPD3303C)

- 3 independent high precision output: 32 V/3.2 A×2, 2.5 V/3.3 V/5 V/3.2 A×1, total 220 W
- 4 digits voltage and 3 digits current display, min resolution: 10 mV, 10 mA
- Three output modes: independent, series and parallel
- 100 V/120 V/220 V/230 V compatible design, to meet the need of different power grids
- Smart temperature controlled fan, effectively reduce the noise
- Save/Recall 5 group system specifications, support data storage expansion
- Connected to PC via USB Device, support SCPI command, to meet the control and communication needs

DC Power Supply

Specifications

Model	SPD3303C	SPD3303X-E	SPD3303X
Channels	CH1: DC voltage range: 0-32 V, DC current range: 0-3.2 A CH2: DC voltage range: 0-32 V, DC current range: 0-3.2 A CH3: DC voltage range: 2.5/3.3/5.0 V, DC current range: 0-3.2 A		
Max output power	220 W		
Resolution	10 mV / 10 mA		1 mV / 1 mA
Display digits	LED display 4 digits voltage 3 digits current	4.3 inch TFT-LCD display 4 digits voltage 3 digits current	4.3 inch TFT-LCD display 5 digits voltage 4 digits current
Ripple noise	CV/CH3: ≤ 1 mVrms (5 Hz~1 MHz) CC: ≤ 3 mArms		
Standard interface	USB Device	USB Device, LAN	
Dimension	225 mm (W)×136 mm (H)×275 mm (D)		
Weight	7.5 kg (SPD3303C) 8 kg (SPD3303X/X-E)		

• Panel displays the timing output

Through front panel operation, 5 groups of timing settings and output control can be displayed, which provides users a simple power programming function. Also a connection can be made with Siglent's EasyPower PC software providing a full range of communication and control requirements.

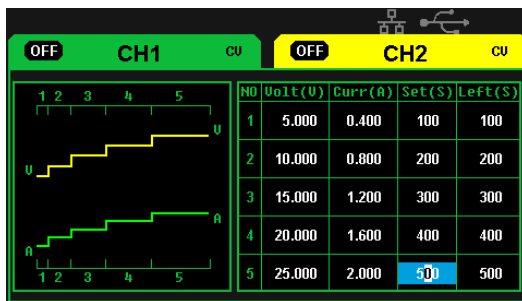

Panel timing output

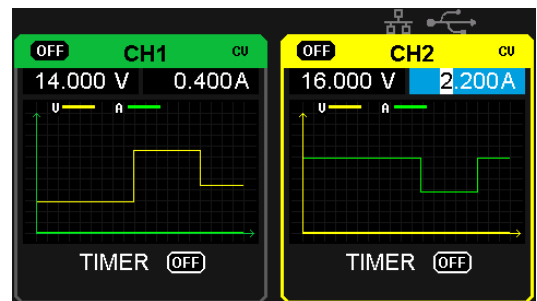

Real time wave display

• Save/Recall setting parameters

SPD3000X series programmable power supply can save or recall 5 groups of setting parameter in internal storage, also supports external storage expansion. You can easily obtain the settings you needed.

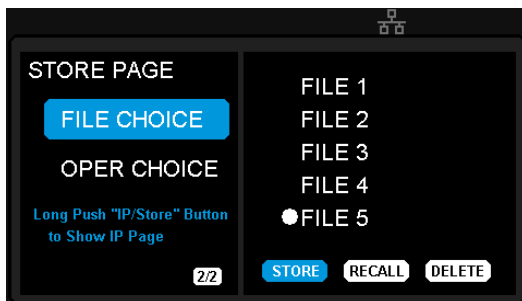

Internal Storage

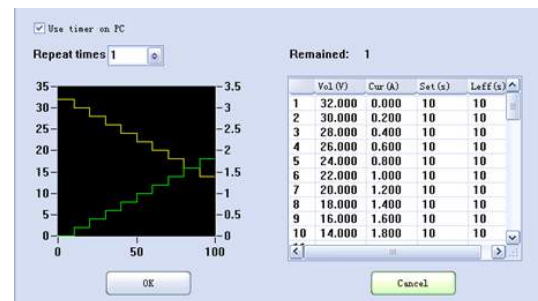

PC Timer



SDM3055 Digital Multimeter

Application

- Research & Development Laboratory
- Detection and Maintenance
- Calibration Laboratory
- Automatic Production Test

Key Features

- Real 5 1/2 digits readings resolution
- Up to 150 rdgs/s measurement speed
- True-RMS AC Voltage and AC Current measuring
- 1 Gb Nand flash size, Mass storage configuration files and data files
- Built-in cold terminal compensation for thermocouple
- Standard interface: USB Device, USB Host, LAN, GPIB (only for SDM3055A)
- Support remote control via commands and compatible with commands of main stream multimeters



PLCs



Acquisition



Instruments



Data logger



Power



HMIs



Switches



Motion



Sensors



Converters



Keyboards



SCADA



Telemetry

Digital Multimeter

Specifications

DC Characteristic

Accuracy± (% of Reading +% of Range) ^[1]

Function	Range ^[2]	Test current or Load voltage	1 Year 23°C±5°C	Temperature coefficient 0°C~18°C 28°C~50°C
DC Voltage	200 mV		0.015+0.004	0.0015+0.0005
	2 V		0.015+0.003	0.0010+0.0005
	20 V		0.015+0.004	0.0020+0.0005
	200 V		0.015+0.003	0.0015+0.0005
	1000 V ^[4]		0.015+0.003	0.0015+0.0005
DC Current	200 µA	<8 mV	0.055+0.005	0.003+0.001
	2 mA	<80 mV	0.055+0.005	0.002+0.001
	20 mA	<0.05 V	0.095+0.020	0.008+0.001
	200 mA	<0.5 V	0.070+0.008	0.005+0.001
	2A	<0.1 V	0.170+0.020	0.013+0.001
	10 A ^[5]	<0.3 V	0.250+0.010	0.008+0.001
Resistance ^[3]	200 Ω	1 mA	0.030+0.005	0.0030+0.0006
	2 KΩ	1 mA	0.020+0.003	0.0030+0.0005
	20 KΩ	100 µA	0.020+0.003	0.0030+0.0005
	200 KΩ	10 µA	0.020+0.010	0.0030+0.0005
	2 MΩ	1 µA	0.040+0.004	0.0040+0.0005
	10 MΩ	200 nA	0.250+0.003	0.0100+0.0005
Diode Test	2.0 V ^[6]	1 mA	0.05+0.01	0.0050+0.0005
Continuity Test	2000 Ω	1 mA	0.05+0.01	0.0050+0.0005

Remarks:

[1]Specifications are for 0.5 hour warm-up, "Slow" measurement rate and calibration temperature 18 °C~28°C.

[2]20% over range on all ranges except for DCV 1000 V, ACV 750 V, DCI 10 A and ACI 10 A.

[3]Specifications are for 4-wire measure or 2-wire measure under "REF" operation. ±0.2 Ω of extra errors will be generated if perform 2-wire measure without "REF" operation.

[4]Plus 0.02 mV of error per 1 V after the first ±500 VDC.

[5]30 seconds OFF after 30 seconds ON is recommend for the continuous current that higher than DC 7 A or AC RMS 7 A.

[6]Accuracy specifications are only for voltage measuring at input terminal. The typical value of current under measure is 1 mA. Voltage drop at diode junction may vary with current supply.

Features

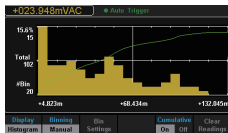

Histogram

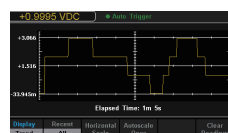

Trend Chart



Bar Chart



Interface

Standard Accessories





SDM3045X Digital Multimeter

Application

- Research Laboratory
- Development Laboratory
- Detection and Maintenance
- Calibration Laboratory
- Automatic Production Test

Key Features

- Real 4½ digit readings resolution
- Up to 150 rdgs/s measurement speed
- True-RMS AC Voltage and AC Current measuring
- 1 Gb Nand flash size, Mass storage configuration files and data files
- Built-in cold terminal compensation for thermocouple
- With easy, convenient and flexible PC software: EasySDM
- Standard interface: USB Device, USB Host, LAN
- Supports remote control via commands and compatible with commands of main stream multimeters



PLCs



Acquisition



Instruments



Data logger



Power



HMIs



Switches



Motion



Sensors



Converters



Keyboards



SCADA



Telemetry

Measuring Method and other Characteristics

DC Voltage	
Input Resistance	600 mV 10 M Ω or 10 G Ω selectable 6 V, 60 V, 600 V and 1000 V Range 10 M Ω \pm 2%
Input Bias Current	<90 pA, 25°C
Input Protection	1000 V on all ranges
CMRR	120 dB (For the 1 K Ω unbalanced resistance in LO lead, max \pm 500 VDC)
NMRR	60 dB at "slow" measurement rate
Resistance	
Testing Method	4-wire resistance or 2-wire resistance selectable
Input Protection	1000 V on all ranges
DC Current	
Shunt Resistor	600 μ A sampling voltage < 33 mV
	6 mA sampling voltage < 0.33 V
	1 Ω for 60 mA, 600 mA 1 Ω
	0.01 Ω for 6 A, 10 A
Input Protection	Rear panel : accessible 10 A, 250 V fast-melt fuse
	Internal : 12 A, 250 V slow-melt fuse
Continuity/Diode Test	
Measurement Method	1 mA \pm 5% constant-current source or open-circuit voltage
Beeper	yes
Continuity Threshold	Adjustable
Input Protection	1000 V
True-RMS AC Voltage	
Measurement Method	AC Coupled true RMS measure – up to 1000 V DC bias are permitted on every range.
Wave Crest Factor	\leq 3 at full scale
Input Impedance	1 M Ω \pm 2% in parallel with <100 pF on all ranges
AC Filter Bandwidth	20 Hz ~ 100 KHz
CMRR	60 dB (For the 1 K Ω imbalance resistance among Lo lead and <60 Hz, Max \pm 500 VDC)
True-RMS AC Current	
Measurement Method	DC Coupled to the fuse and shunt; AC Coupled the True-RMS measurement (measures the AC components only)
Wave Crest Factor	\leq 3 at full scale
Max Input	<10 A (include DC component)
Shunt Resistor	1 Ω for 60 mA, 600 mA 1 Ω ; 0.01 Ω for 6 A, 10 A
Input Protection	Rear panel : accessible 10 A, 250 V fast-melt fuse
	Internal : 12 A, 250 V slow-melt fuse
Frequency/Period	
Measurement Method	Reciprocal-counting technique, AC Coupled input, AC voltage or AC current measurement function
Measure Attentions	Error are leaded into all frequency counters when measuring low voltage or low frequency signal.
Capacitance Measuring	
Measurement Method	Measure the rate of change of voltage generated during the current flowing the capacitance
Connection Type	2-wire
Input Protection	1000 V on all ranges

Order Information

Product name	SIGLENT SDM3045X Digital Multimeter
Models	SDM3045X
Standard Accessories	A power Cord that fits the standard of destination country
	Two Test Leads, Two Alligator Clips
	A USB Cable
	A Quick Start
	A Guaranty Card
	A CD (Including EasySDM computer software system)



SSA3000X Spectrum Analyzer

Key Features

- All-Digital IF Technology
- Frequency Range from 9 kHz up to 3.2 GHz
- -161 dBm/Hz Displayed Average Noise Level (Typ.)
- -98 dBc/Hz @10 kHz Offset Phase Noise (1 GHz, Typ.)
- Total Amplitude Accuracy < 0.7 dB
- 10 Hz Minimum Resolution Bandwidth (RBW)
- Standard Pre-amplifier
- Up to 3.2 GHz Tracking Generator Kit (Opt.)
- Reflection Measurement Kit (Opt.)
- Advanced Measurement Kit (Opt.)
- EMI Pre-compliance Measurements Kit (Opt.)
- 10.1 Inch WVGA (1024x600) Display



PLCs



Acquisition



Instruments



Data logger



Power



HMI's



Switches



Motion



Sensors



Converters



Keyboards

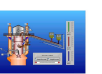

SCADA



Telemetry

Spectrum Analyzer

Characteristics

- Support four traces and cursors independently

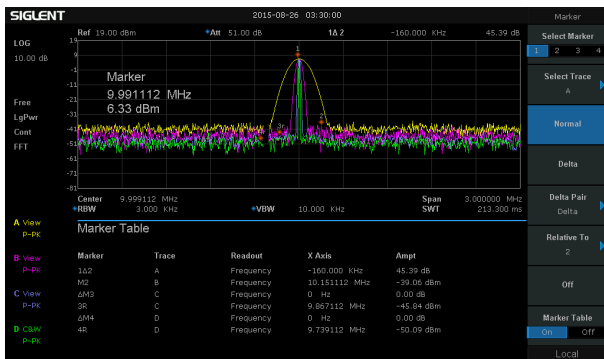

- 10 Hz Minimum Resolution Bandwidth (RBW)

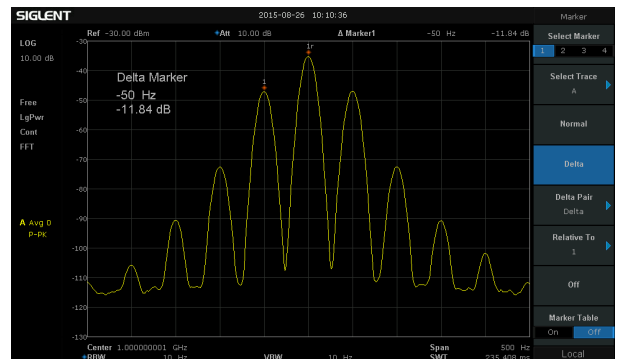

- 151 dBm Displayed Average Noise Level (RBW=10 Hz)

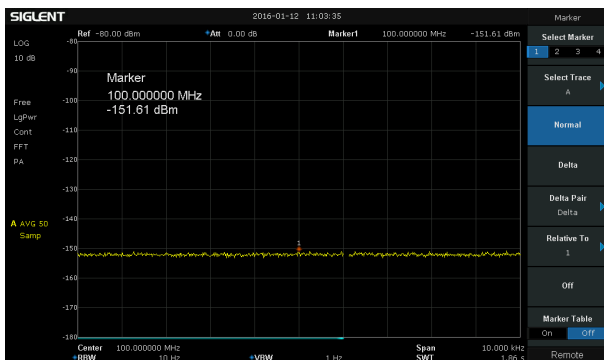

- Phase noise -98 dBc/Hz@1 GHz, offset 10 kHz

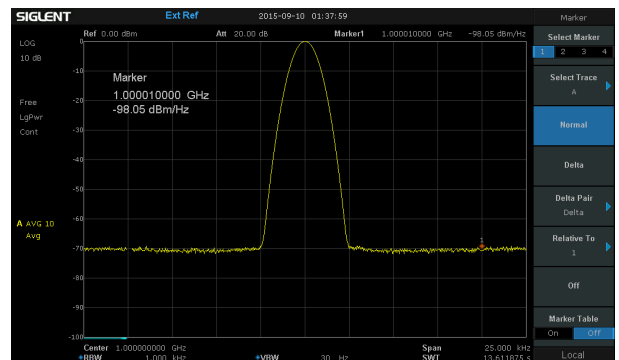

- Demodulation at the zero span

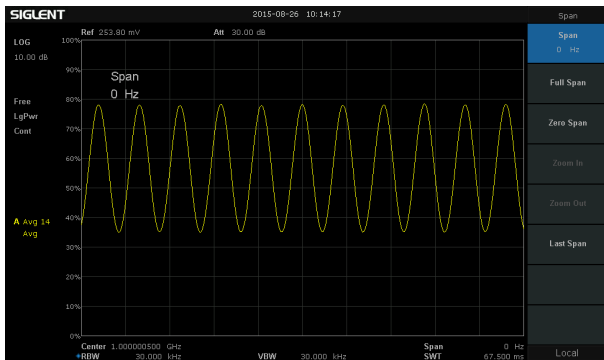

- Advanced power measurement, calculate the ACPR parameters

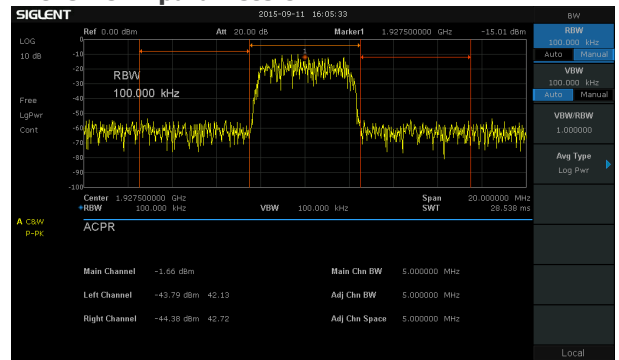

- Reflection measurement, acquire characteristic curve of the Return Loss

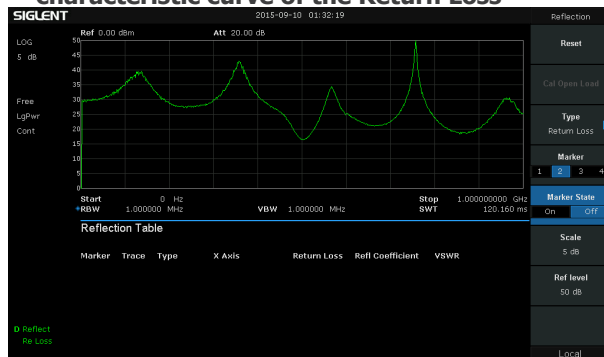

- EMI filter, Quasi-Peak detector following CISPR 16

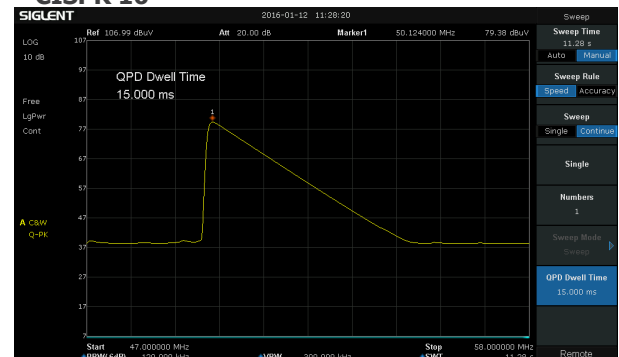

Specifications

Model	SSA3032X	SSA3021X
Frequency Range	9 kHz~3.2 GHz	9 kHz~2.1 GHz
Resolution Bandwidth	10 Hz~1 MHz, in 1-3-10 sequence	10 Hz~1 MHz, in 1-3-10 sequence
Displayed Average Noise Level	-161 dBm/Hz, Normalize to 1 Hz (typ.)	-161 dBm/Hz, Normalize to 1 Hz (typ.)
Phase Noise	<-98 dBc/Hz@1 GHz, 10 kHz offset	<-98 dBc/Hz@1 GHz, 10 kHz offset
Amplitude Precision	< 0.7 dB	< 0.7 dB

Ordering Information

Product Description	SSA3000X Spectrum Analyzer	Order Number	
Product code	Spectrum Analyzer, 9 kHz~3.2 GHz	SSA3032X	
	Spectrum Analyzer, 9 kHz~2.1 GHz	SSA3021X	
Standard configurations	A Quick Start, A Product Certification, A USB Cable, A CD (Including Quick Start, Data Sheet and Application Software) , A Calibration Certificate	QG-SSA3000X	
Utility Options	Tracking Generator Kit (Software)	TG-SSA3000X	
	Advanced Measurement Kit (Software)	AMK-SSA3000X	
	Utility Kit: N (M)-SMA (M) cable N (M)-N (M) cable N (M)-BNC (F) adaptor (2 pcs) N (M)-SMA (F) adaptor (2 pcs) 10 dB attenuator	UKitSSA3X	
	N (M)-SMA (M) cable	N-SMA-6L	
	N (M)-N (M) cable	N-N-6L	
	N (M)-BNC (M) cable	N-BNC-2L	
	Soft carrying bag	BAG-SCC	
	EMI Options	EMI Measurement Kit (Software)	EMI-SSA3000X
	Near Field Probe: H field probe (25 mm, 10 mm, 5 mm, 2 mm) , 30 MHz~3.0 GHz	SRF5030	
Reflect Measurement Options	Tracking Generator Kit (Software)	TG-SSA3000X	
	Reflect Measurement Kit (Software)	Refl-SSA3000X	
	VSWR Bridge Kit: Including Refl-SSA3000X (Software) VSWR Bridge (1 MHz ~ 2 GHz) N(M)-N(M) adapter (2 pcs)	RBSSA3X20	



SHS1000 Handheld Digital Oscilloscope

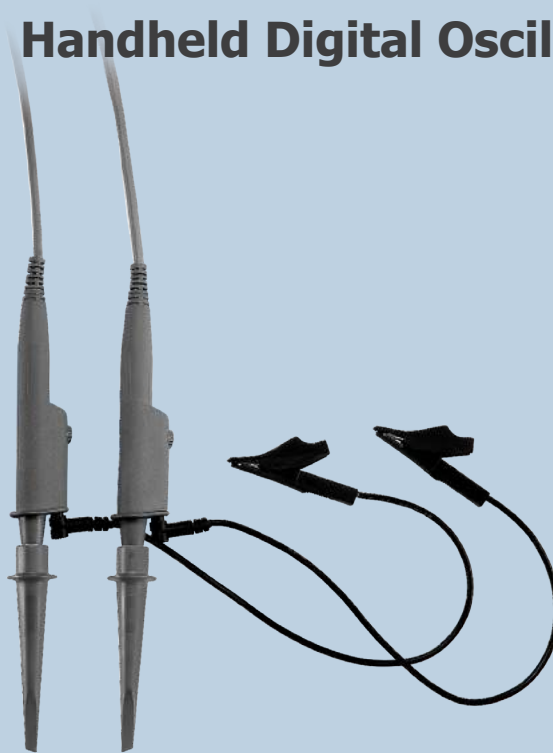

Application

- Embedded electronic circuit design and test
- Mechanical and electrical products design and analysis
- Manufacturing and circuit function test
- Differential signal analysis
- Floating signal measurements

Key Features

- Combines the functions of oscilloscope, multimeter and recorder in one
- Isolated oscilloscope channels, isolation level: CAT II 1000 V and CAT III 600 V
- 60 MHz/100 MHz bandwidth, 1 G sampling rate, 2 M memory depth, 7 M recording length
- Built-in lithium battery
- 5.7 inch color TFT-LCD



PLCs



Acquisition



Instruments



Data logger



Power



HMIs



Switches



Motion



Sensors



Converters



Keyboards



SCADA



Telemetry

Specification

Model	SHS1102	SHS1062
Bandwidth	100 MHz	60 MHz
Rise time	≤3.5 ns	≤5.8 ns
Real time sampling rate	1 GSa/s	
Equivalent sampling rate	50 GSa/s	
Vertical sensitivity	5 mV – 100 V/div	
Time base range	2.5 ns – 50 ns/div Scan:100 ms – 50 s/div	5 ns – 50 s/div
Memory depth	2 Mpts	
Triggering	Edge, Pulse, Video, Slope, Alternative	
Vertical resolution	8 bit	
Triggering frequency counter	6 digits	
Data recorder	7 M points	
Trend plot	800 K/CH	
Interface	USB Device, USB Host	
Math operation	+, -, *, /, FFT	

Multimeter Specification

Maximum resolution	6000 Counts	
Item	Range	Accuracy
DC voltage	60 mV	±1%±15 digit
	600 mV – 1000 V	±1%±5 digit
AC voltage	60 mV	±1%±15 digit
	600 mV – 750 V	±1%±5 digit
DC current	60 mA – 600 mA	±1%±5 digit
	6 A – 10 A	±1.5%±5 digit
AC current	60 mA – 600 mA	±1%±5 digit
	6 A – 10 A	±1.5%±5 digit
Capacitance	40 nF	±3%±10 digit
	400 nF – 400 uF	±4%±5 digit
Resistance	600 Ω-60 MΩ	±1%±5 digit
Continuity	<50 Ω Buzzer sounds	
Diode	0 V – 2 V	
Trend plot	1.2 M points	
Measuring mode	Manual/Auto	

Handheld Oscilloscope

Isolation Level

Max input Voltage	
Input by input port directly	CATII 300 V
Input by 10: 1 probe	CATII 1000 V, CAT III 600 V
The Max input voltage of Multimeter	DC 1000 V, AC 750 V
Max floating voltage	
Float voltage between BNC reference and earth ground	CATII 1000 V, CAT III 600 V
Float voltage between BNC reference	CATII 1000 V, CAT III 600 V
Float voltage between multimeter reference and earth ground	CATII 600 V, CAT III 300 V

Security: Isolated Handheld Digital Oscilloscope should be designed according to the standard of level II and pollution degree level II which apply to measure 1000 V. Or according to the standard of level III and pollution degree level III which apply to measure 600 V.

Multimeter Specification

Display	5.7 inch color TFT-LCD, 320*234
Power supply	With battery or apply DC adapter to get power from outside
Power mode	Lithium battery: 7.4 V 4500 mAh, Battery persisting > 4 hours DC adapter: 100-240 V 50/60 Hz input 9 V 4 A output.
Net Weight	1.5 Kg
Dimension	259.5 mm*163.2 mm*53.3 mm
Accessories	Two Passive Probes, Multimeter pen, USB data cable, DC adapter, Manual, CD, Toolbox.

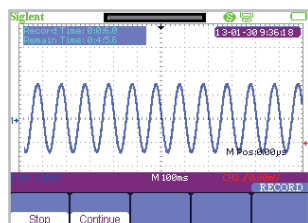

High-performance oscilloscope

- Bandwidth: 100 MHz, 60 MHz
- Real-time sampling rate: 1 GSa/s
- Memory depth: 2 Mpts.

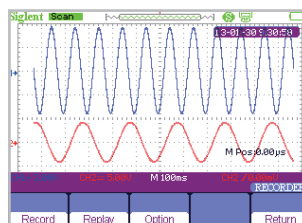

Data recorder function

- 7 M internal storage, up to 18 hours recording time
- USB port, up to 3000 hours recording time
- Record, replay function supported

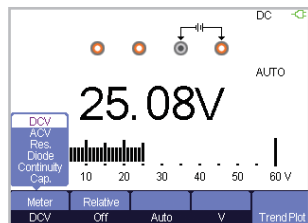

High precision multimeter

- 6000 counts display
- Accurate measurement of DCV, ACV, DCI, ACI
- Accurate measurement of Resistance, Diode, Capacitance, Continuity

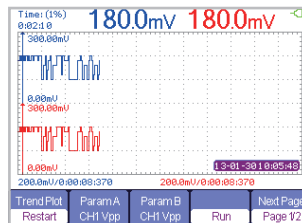

Trend Plot

- 32 measurement trend plot analyzer
- Scope: 800 k/CH points capacity, more than 24 hours recording
- Meter: 1.2 M points capacity 6000 hours recording time at 0.05 Sa/s



SHS800 Handheld Digital Oscilloscope



Application

- Automotive electronics, electric automobile test
- Power system strong electricity test
- Plant automation control system

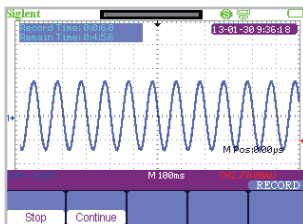

High-performance oscilloscope

- Bandwidth: 100 MHz, 60 MHz
- Real-time sampling rate: 1 GSa/s
- Memory depth: 2 Mpts.

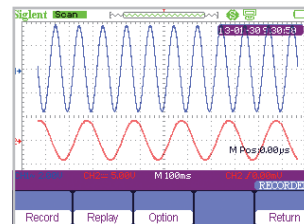

Data recorder function

- 7 M internal storage, up to 18 hours recording time
- USB port, up to 3000 hours recording time
- Record, replay function supported

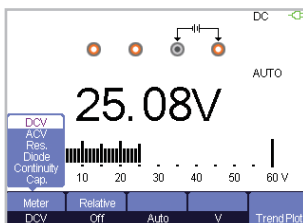

High precision multimeter

- 6000 counts display
- Accurate measurement of DCV, ACV, DCI, ACI
- Accurate measurement of Resistance, Diode, Capacitance, Continuity

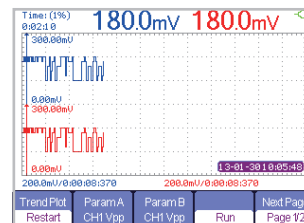

Trend Plot

- 32 measurement trend plot analyzer
- Scope: 800 k/CH points capacity, more than 24 hours recording
- Meter: 1.2 M points capacity 6000 hours recording time at 0.05 Sa/s

Handheld Oscilloscope

Oscilloscope Specification











Model	SHS820	SHS810	SHS806
Bandwidth	200 MHz	100 MHz	60 MHz
Rise time	≤1.75 ns	≤3.5 ns	≤5.8 ns
Real time sampling rate	500 MSa/s	1 GSa/s	
Equivalent sampling rate	50 GSa/s		
Vertical sensitivity	2 mV – 100 V/div		
Time base range	2.5 ns – 50 ns/div Scan:100 ms – 50 s/div		5 ns – 50 s/div
Memory depth	32 Kpts	2 Mpts	
Triggering	Edge, Pulse, Video, Slope, Alternative		
Vertical resolution	8 bit		
Triggering frequency counter	6 digits		
Data Recorder	7 M points		
Trend plot	800 K/CH		
Interface	USB Device, USB Host		
Math operation	+, -, *, /, FFT		

Multimeter Specification













Maximum resolution	6000 Counts	
Item	Range	Accuracy
DC Voltage	60 mv	±1%±15 digit
	60 mv – 1000 v	±1%±5 digit
AC Voltage	60 mv	±1%±15 digit
	600 mV – 750 V	±1%±5 digit
DC Current	60 mA	±1%±5 digit
	6 A – 10 A	±1.5%±5 digit
AC Current	60 mA	±1%±5 digit
	6 A – 10 A	±1.5%±5 digit
Capacitance	40 nF	±3%±10 digit
	400 nF – 400 μF	±4%±5 digit
Resistance	600 Ω – 60 MΩ	±1%±5 digit
Continuity	<50 Ω Buzzer sounds	
Diode	0 V – 2 V	
Trend plot	1.2 M points	
Measuring mode	Manual/Auto	

General Feature

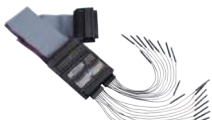
Display	5.7 inch color TFT-LCD, 320*234
Power supply	Charging/Battery
Power mode	Lithium battery: 7.4 V 5000 mAh, Battery lasts >5 hours; DC adapter, 100-240 V 50/60 Hz input, 9 V 4 A output
Net weight	1.5 Kg
Dimension	259.5 mm*163.2 mm*53.3 mm
Accessories	Two passive probes, multimeter pen, USB data cable, DC adapter, manual, CD.

Type	Model	Picture	Specifications
Passive Probe	PB470 PP510 PP215 PP430		PB470,70 MHz bandwidth PP510,100 MHz bandwidth PP215,200 MHz bandwidth PP430,300 MHz bandwidth 1 X/10 X decay, 1 M/10 Mohm, 300 V/600 V
	PB925		Bandwidth 250 MHz, fixed 10 X decay, the rise time of about 1.2 ns, input capacitance: 16 pF, compensation range: 10 pF-35 pF, input impedance 10 M Ω , length 120 cm, safe voltage levels: CAT II 1000 V, CAT III 600 V
	PB830		Bandwidth 300 MHz, fixed 10 X decay, the rise time of about 1 ns, input capacitance: 16 pF, compensation range: 10 pF-20 pF, input impedance 10 M Ω , length 140 cm, safe voltage levels: CAT II 1000 V, CAT III 600 V
Current Probe	CP4020		Bandwidth: 100 KHz; Maximum continuous current 20 Arms; Peak current 60 A; Switching ratio: 50 mV/A; 5 mV/A; DC measurement accuracy: 50 mV/A (0.4 A-10 ApK) \pm 2%; 5 mV/A (1 A-60 ApK) \pm 2%; 9 V battery-powered
	CP4050		Bandwidth: 1 MHz; Maximum continuous current 50 Arms; Peak current 140 A; Switching ratio: 500 mV/A; 50 mV/A; DC measurement accuracy: 500 mV/A (20 mA-14 ApK) \pm 3% \pm 20 mA; 50 mV/A (200 mA-100 ApK) \pm 4% \pm 200 mA; 50 mV/A (100 A-140 ApK) \pm 15% max; 9 V battery-powered
	CP4070		Bandwidth: 150 KHz; Maximum continuous current 70 Arms;Peak current 200 A; Switching ratio: 50 mV/A; 5 mV/A; DC measurement accuracy: 50 mV/A (0.4 A-10 ApK) \pm 2%, 5 mV/A (1 A-200 ApK) \pm 2%;9 V battery-powered
	CP4070A		Bandwidth: 300 KHz; Maximum continuous current 70 Arms; Peak current 200 A;Switching ratio: 100 mV/A;10 mV/A; DC measurement accuracy: 100 mV/A(50 mA-10 ApK) \pm 3% \pm 50 mA; 10 mV/A (500 mA-40 ApK) \pm 4% \pm 50 mA; 10 mV/A (40 A-200 ApK) \pm 15%max; 9 V battery-powered
	CP5030		Bandwidth: 50 MHz; Maximum continuous current 30 Arms; Peak current 50 A;Switching ratio: 100 mV/A; 1 V/A; AC/DC measurement accuracy: 1 A(\pm 1% \pm 1 mA); 100 mV/A(\pm 1% \pm 10 mA); Standard DC12 V/1.2 A power adapter
	CP5030A		Bandwidth: 100 MHz; Maximum continuous current 30 Arms; Peak current 50 A;Switching ratio: 100 mV/A; 1 V/A; AC/DC measurement accuracy: 1 A (\pm 1% \pm 1 mA); 100 mV/A (\pm 1% \pm 10 mA); Standard DC12 V/1.2 A power adapter
	CP5150		Bandwidth: 12 MHz; Maximum continuous current 150 Arms; Peak current 300 A; Switching ratio: 100 mV/A; 1 V/A; AC/DC measurement accuracy: 100 mV/A (\pm 1% \pm 1 mA); 10 mV/A (\pm 1% \pm 10 mA); Standard DC 12 V/1.2 A power adapter
CP5500		Bandwidth: 5 MHz; Maximum continuous current 500 Arms; Peak current 750 A; Switching ratio: 100 mV/A; 10 mV/A; AC/DC measurement accuracy: 100 mV/A (\pm 1% \pm 1 mA); 10 mV/A (\pm 1% \pm 10 mA); Standard DC 12 V/1.2 A power adapter	

Probes & Accessories

Type	Model	Picture	Specifications
High Voltage Differential Probe	DPB4080		Bandwidth: 50 MHz; Maximum input differential voltage 800 V (DC + Peak AC); Range selection (attenuation ratio): 10 X/100 X; Accuracy: ±1%; Standard DC 9 V/1 A power adapter
	DPB5150		Bandwidth: 70 MHz; Maximum input differential voltage 1500 V (DC + Peak AC); Range selection (attenuation ratio): 50 X/500 X; Accuracy: ±2%; Standard 5 V/1 A USB power adapter
	DPB5150A		Bandwidth: 100 MHz; Maximum input differential voltage 1500 V (DC + Peak AC); Range selection (attenuation ratio): 50 X/500 X; Accuracy: ±2%; Standard 5 V/1 A USB power adapter
	DPB5700		Bandwidth: 70 MHz; Maximum input differential voltage 7000 V (DC + Peak AC); Range selection (attenuation ratio): 100 X/1000 X; Accuracy: ±2%; Standard 5 V/1 A USB power adapter
	DPB5700A		Bandwidth: 100 MHz; Maximum input differential voltage 7000 V (DC + Peak AC); Range selection (attenuation ratio): 100 X/1000 X; Accuracy: ±2%; Standard 5 V/1 A USB power adapter
High Voltage Probe	HPB4010		Bandwidth: 40 MHz; Maximum measurement voltage DC: 10 KV; AC(rms): 7 KV (sine); AC (Vpp): 20 KV (Pulse); attenuation ratio 1:1000; Accuracy: ≤3%
Logic Probe	SPL1016		Logic Probe for SDS1000X+ series, 16-channel, 500 MSa/s
	SPL2016		Logic Probe for SDS2000X series, 16-channel, 500 MSa/s
Near-field probe	SRF5030		Four near-field probes; Frequency range: 30 MHz ~ 3 GHz; resolution 25 mm; distinguished within 10 cm range of the magnetic field; for EMI radiation interference and the intensity detector
Preamplifier	EM5020		Maximum linear output power 10 dBm; Frequency range: 9 KHz ~ 3 GHz; typical gain of about 20 dB ~ 30 dB; Maximum input power 13 dBm ~ 15 dBm
Isolated front end	ISFE		Realize isolation among ordinary oscilloscope channels, isolation between the measured signal and ground, use USB 5 V power supply, plug and play, the maximum input voltage of up to ± 600 Vpk
GPIB	USB-GPIB		The USB Device interface extends into the GPIB interface, USB-GPIB adapter can more easily complete the task of the operation command through the GPIB, USB follow the USB2.0 specification, GPIB follow the IEEE488.2 standard
Demo board	STB Test Board		Output signals include square waves, sine, random, pulse, BURST, fast edge signal and amplitude modulation signal, 10 kinds of signals

Deskew fixture	DF2001A		Supporting power analysis software for calibration phase voltage and current probes generated during transmission
Cable	N-BNC-2L		N-BNC cable for SSA3000X Series; 2 GHz bandwidth
	N-N-6L		N-N cable for SSA3000X Series; 6 GHz bandwidth
	N-SMA-6L		N-SMA cable for SSA3000X Series; 6 GHz bandwidth
Reflection Bridge	RBSSA3X20		VSWR Bridge Kit for SSA3000X Series: Including Refl-SSA3000X (Software) VSWR Bridge (1 MHz ~ 2 GHz) N(M)-N(M) adaptor (2 pcs)
SSA3000X Utility Kit	UKitSSA3X		Utility Kit for SSA3000X Series: N (M) -SMA (M) cable, N (M) -N (M) cable, N (M) -BNC (F) adaptor (2 pcs), N (M) -SMA (F) adaptor (2 pcs), 10 dB attenuator;



PLCs



Acquisition



Instruments



Data logger



Power



HMIs



Switches



Motion



Sensors



Converters



Keyboards



SCADA

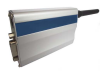

Telemetry

Service Promise:

Since the date of purchase, we offer three year's warranty for the main unit:

- During the warranty period, if the products cause any hardware or software failure because of the quality, Siglent's after-sales service center or Siglent's designated maintenance points will offer the maintenance of the fault products for the user.
- Because of improper use or any other artificial reason, the damage won't be included in the free maintenance.

1. Extension after-sales service

Extension service is based on the main unit (not including accessories) as an object. During the extension service, Siglent still offer free maintenance after the standard warranty period.

1.1 Three advantages:

- Guarantee investment. To extend the life cycle of the products
- Save money. To prevent the high cost of maintenance after the warranty period.
- Avoid the repeated investment. To prevent buying new equipments because it can't be repaired after the warranty period.

1.2 The content of the extension service

You can buy the following extension service according to your demand:

Solution	Viability	Instruction
ES4	One year after the warranty period	According to the service terms, Siglent will offer another one year for the after-sales maintenance service
ES5	Two years after the warranty period	According to the service terms, Siglent will offer another two years for the after-sales maintenance service

2. Calibration services

After long-term use, oscilloscope will cause the deviation of measured value and waveform display, because of its work temperature and humidity. Siglent will restore the original performance and accuracy of factory setting to calibrate the deviation.

- Eliminate the error of measurement
- Restore the original performance and accuracy of the factory setting to the "new" state
- The upgrade of the firmware and the software
- Make the instruments comply with the standard of the ISO9001 quality management process
- Traceable calibration certificates



PLCs



Acquisition



Instruments



Data logger



Power



HMIs



Switches



Motion



Sensors



Converters



Keyboards



SCADA

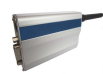

Telemetry