

# Quick Start

## SDS1000CML+/SDS1000DL+ Series Digital Oscilloscope

QS0101A-E01B

2016 SIGLENT TECHNOLOGIES CO., LTD

# Guaranty and Declaration

## Copyright

SIGLENT TECHNOLOGIES CO., LTD. All Rights Reserved.

## Trademark Information

**SIGLENT** is the registered trademark of SIGLENT TECHNOLOGIES CO., LTD

## Declaration

- **SIGLENT** products are protected by patent law in and outside of P.R.C.
- **SIGLENT** reserves the right to modify or change parts of or all the specifications or pricing policies at company's sole decision.
- Information in this publication replaces all previously corresponding material.
- Any way of copying, extracting or translating the contents of this manual is not allowed without the permission of **SIGLENT**.
- **SIGLENT** will not be responsible for losses caused by either incidental or consequential in connection with the furnishing, use or performance of this manual as well as any information contained.

## Product Certification

**SIGLENT** guarantees this product conforms to the national and industrial standards in china as well as the ISO9001: 2008 standard and the ISO14001: 2004 standard. Other international standard conformance certification is in progress.

# Safety Requirement

## General Safety Summary

Carefully read the following safety precautions to avoid personal injuries and prevent damage to the instrument and any products connected to it. To avoid potential hazards, please use the instrument as specified.

**Only qualified technician should perform service procedures**

### To Avoid Fire or Personal Injuries

#### Use Proper Power Line

Use only the special power line of the instrument which is approved by local state.

#### Ground the Instrument

The instrument grounds through the protective terra conductor of the power line. To avoid electric shock, the ground conductor must be connected to the earth. Make sure the instrument is grounded correctly before connecting its input or output terminals.

#### Connect the Signal Wire Correctly

The potential of the signal wire is equal to the earth, so do not connect the signal wire to a high voltage. Do not touch the exposed contacts or components.

#### Look Over All Terminals' Ratings

To avoid fire or electric shock, please look over all ratings and sign instruction of the instrument. Before connecting the instrument, please read the manual carefully to gain more information about the ratings.

**Do not Operate with Suspected Failures**

If you suspect that there is a damage of the instrument, please let a qualified service personnel check it.

**Avoid Circuit or Components Exposed**

Do not touch exposed contacts or components when the power is on.

**Do not Operate in Wet/Damp Conditions****Do not Operate in an Explosive Atmosphere****Keep the Surface of the Instrument Clean and Dry**

## Safety Terms and Symbols

**Terms on the product.** These terms may appear on the product:

**DANGER:** Indicates direct injuries or hazards that may happen.

**WARNING:** Indicates potential injuries or hazards that may happen.

**CAUTION:** Indicates potential damages to the instrument or other property that may happen.

**Symbols on the product.** These symbols may appear on the product:



**Hazardous  
Voltage**



**Protective  
Earth Ground**



**Warning**



**Earth Ground**



**Power  
Switch**

## General Care and Cleaning

### Care:

Do not store or leave the instrument in direct sunshine for long periods of time.

### Notice:

- To avoid damages to the instrument or probe, please do not leave them in fog, liquid, or solvent.

### Cleaning:

Please perform the following steps to clean the instrument and probe regularly according to its operating conditions.

1. Disconnect the instrument from all power sources, and then clean it with a soft wet cloth.
2. Clean the loose dust on the outside of the instrument and probe with a soft cloth. When cleaning the LCD, take care to avoid scarifying it.

### Notice:

- To avoid damages to the surface of the instrument and probe, please do not use any corrosive liquid or chemical cleanser.
- Make sure that the instrument is completely dry before restarting it to avoid short circuits or personal injuries.

---

## Contents

<b>Guaranty and Declaration .....</b>	<b>I</b>
<b>Safety Requirement .....</b>	<b>II</b>
<b>Safety Terms and Symbols.....</b>	<b>III</b>
<b>General Care and Cleaning .....</b>	<b>IV</b>
<b>Quick start .....</b>	<b>1</b>
<b>General Inspection .....</b>	<b>1</b>
<b>Appearance and Dimension.....</b>	<b>2</b>
<b>Adjust the Supporting Legs .....</b>	<b>3</b>
<b>Connect to AC Power Supply.....</b>	<b>4</b>
<b>Power-on Inspection .....</b>	<b>5</b>
<b>Connect the Probe.....</b>	<b>6</b>
<b>Function Inspection .....</b>	<b>7</b>
<b>Probe Compensation .....</b>	<b>8</b>
<b>The Rear Panel.....</b>	<b>10</b>
<b>Function Introduction of Front Panel.....</b>	<b>11</b>
<b>Vertical Control.....</b>	<b>11</b>
<b>Horizontal Control.....</b>	<b>13</b>
<b>Trigger Control .....</b>	<b>14</b>
<b>RUN/STOP .....</b>	<b>15</b>
<b>SINGLE .....</b>	<b>15</b>
<b>AUTO.....</b>	<b>15</b>
<b>Universal Knob .....</b>	<b>16</b>
<b>Function Menus.....</b>	<b>17</b>
<b>DEFAULT SETUP .....</b>	<b>18</b>
<b>HELP Information .....</b>	<b>18</b>
<b>PRINT .....</b>	<b>18</b>
<b>User Interface.....</b>	<b>19</b>
<b>Using Security Lock.....</b>	<b>22</b>
<b>Troubleshooting.....</b>	<b>23</b>
<b>Contact SIGLENT .....</b>	<b>25</b>



# Quick start

## General Inspection

### 1. Inspect the shipping container.

Keep the damaged shipping container or cushioning material until the contents of the shipment have been completely checked and the instrument has passed both electrical and mechanical tests.

The consigner or carrier will be responsible for damages to the instrument resulting from shipment. **SIGLENT** would not provide free maintenance or replacement.

### 2. Inspect the instrument.

If there are instruments found damaged, defective or failure in electrical and mechanical tests, please contact **SIGLENT**.

### 3. Check the accessories.

Please check the accessories according to the packing list. If the accessories are incomplete or damaged, please contact your **SIGLENT** sales representative.



# Appearance and Dimension

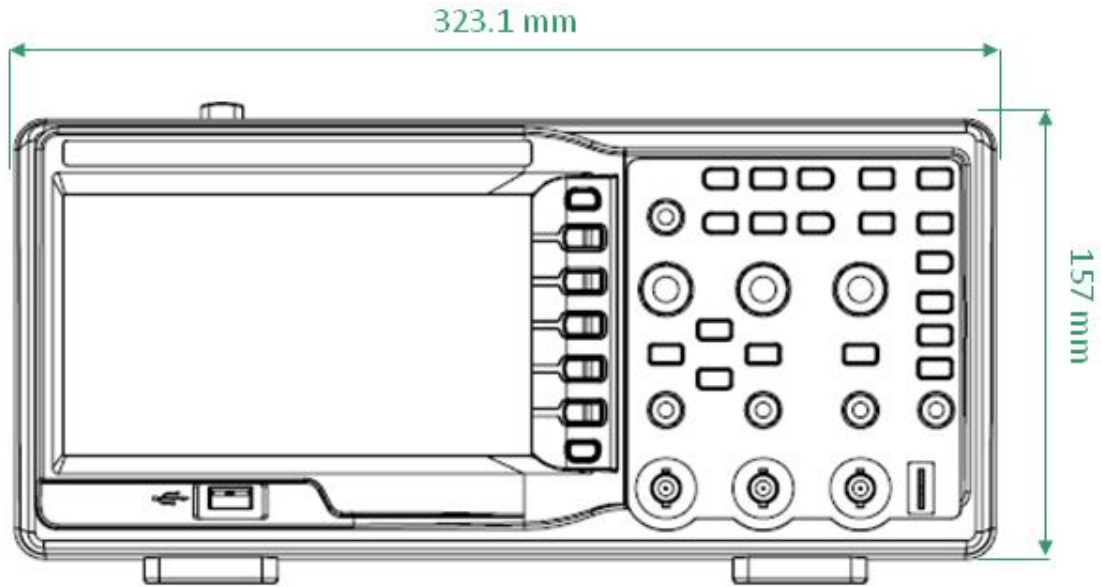

Figure 1 Front View

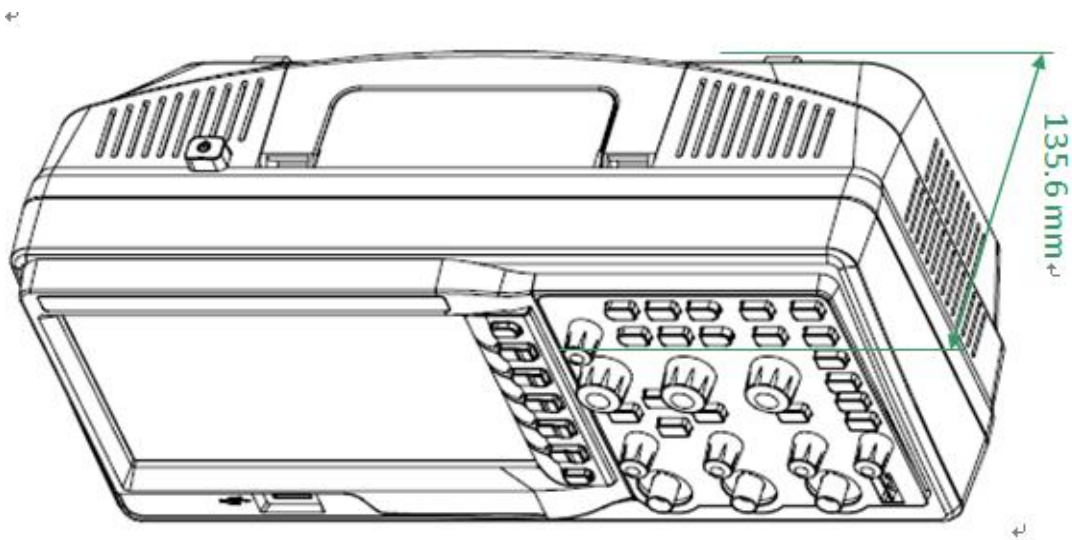

Figure 2 Side View

## Adjust the Supporting Legs

Adjust the supporting legs properly to use them as stands to tilt the oscilloscope upwards for stable placement as well as easier operation and observation of the instrument.

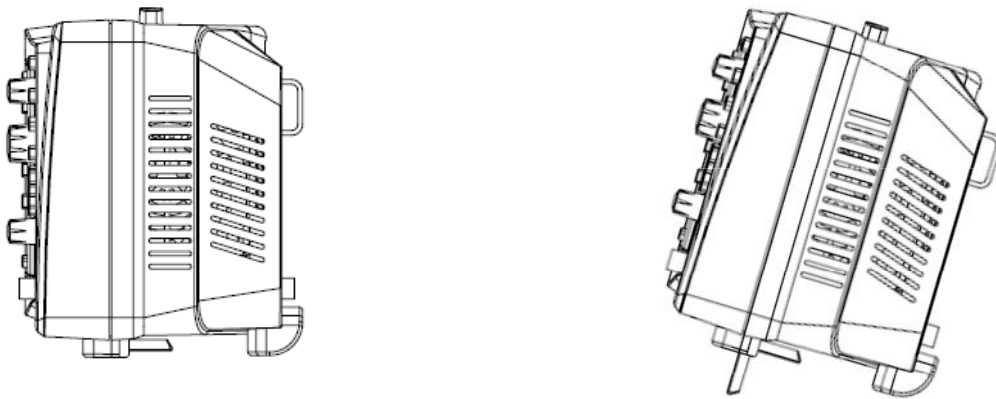
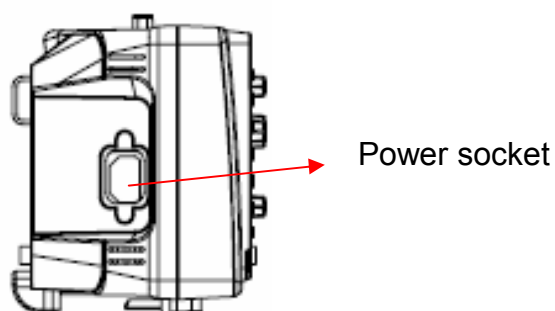

Figure 3 Adjust the Supporting Legs

## Connect to AC Power Supply

The oscilloscope accept 100~240V, 50/60/440Hz AC power supply. Please use the power cord provided as accessories to connect the instrument to the power source as shown in the figure below.



Note: In want of replacing the fuse, please return the instrument to the factory that produced it to have it repaired by qualified service personnel authorized by **SIGLENT**.

## Power-on Inspection

When the scope is energized, press the power key at the top of it to turn it on. During the start-up progress, the instrument performs a series of self-test items and you can hear the sound of relay switching. After the self-test completes, the welcome interface displays immediately.

## Connect the Probe

**SIGLENT** provides passive probes for these series oscilloscope. Please refer to corresponding Probe User Manual for detailed technical information. The following are the probes specified for this oscilloscope.

Type	Description
PB470	70 MHz, passive probe
PP510	100MHz, passive probe
PP215	200 MHz, passive probe

### Connect the probe:

1. Connect the BNC terminal of the probe to one of the channel BNC connector on the front panel.
2. Connect the probe tip to the circuit point to be tested and the ground alligator clip of the probe to the ground terminal of the circuit.

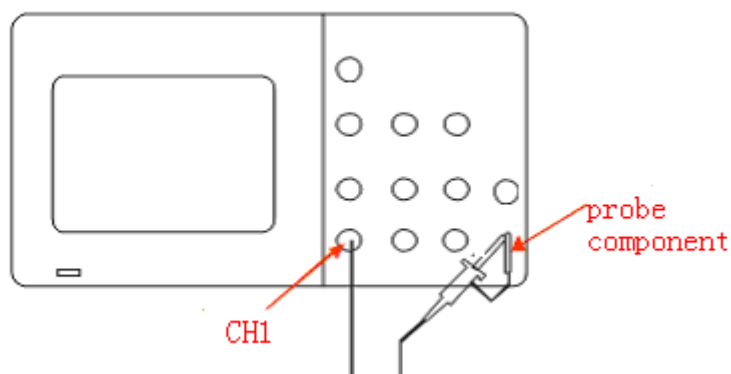

## Function Inspection

1. Press “Default Setup” to restore the oscilloscope to its default settings.
2. Connect the ground alligator clip of the probe to the Ground Terminal on the front panel.
3. Use the probe to connect the CH1 Input Terminal and the Compensation Signal Output Terminal on the front panel.

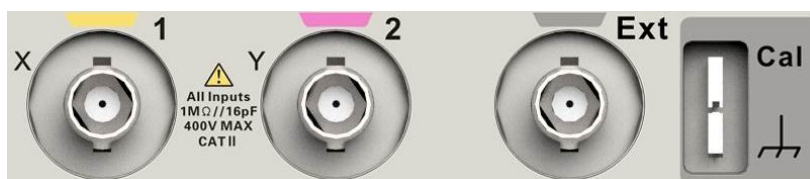

4. Press “Auto”.
5. Observe waveforms on the screen. In normal condition, the display should be several square waveforms as is shown below:

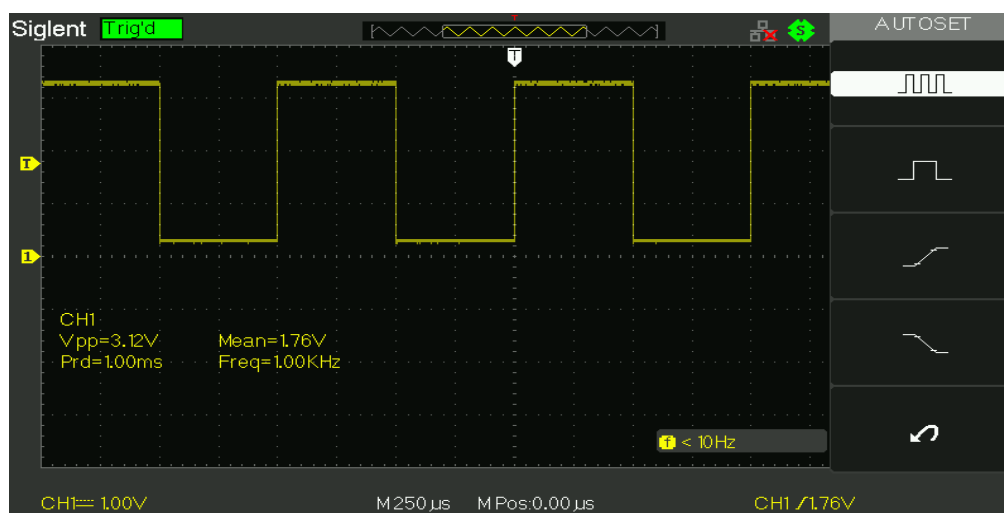

6. Test channel 2 in the same method. If the square waveforms do not display like figure above, please perform “Probe Compensation”.

**Note:** To avoid electric shock when using the probe, please firstly make sure that the insulated wire of the probe is in good condition, and do not touch the metallic part of the probe when it is connected to a high voltage.

## Probe Compensation

You should properly compensate the probe at first use of it. Non-compensated or inadequate compensated probe may cause inaccurate measurement. The following steps are about probe compensation:

1. Perform step 1, 2, 3 and 4 of “Function Inspection”.
2. Check the displayed waveforms and compare them with the following figure.

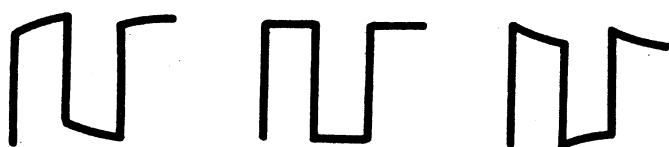

Under Compensated      Compensated Correctly      Over Compensated

3. Use a nonmetallic driver to adjust the low-frequency compensation adjustment hole on the probe until the waveform changes to be correct as the figure above.

# The Front Panel

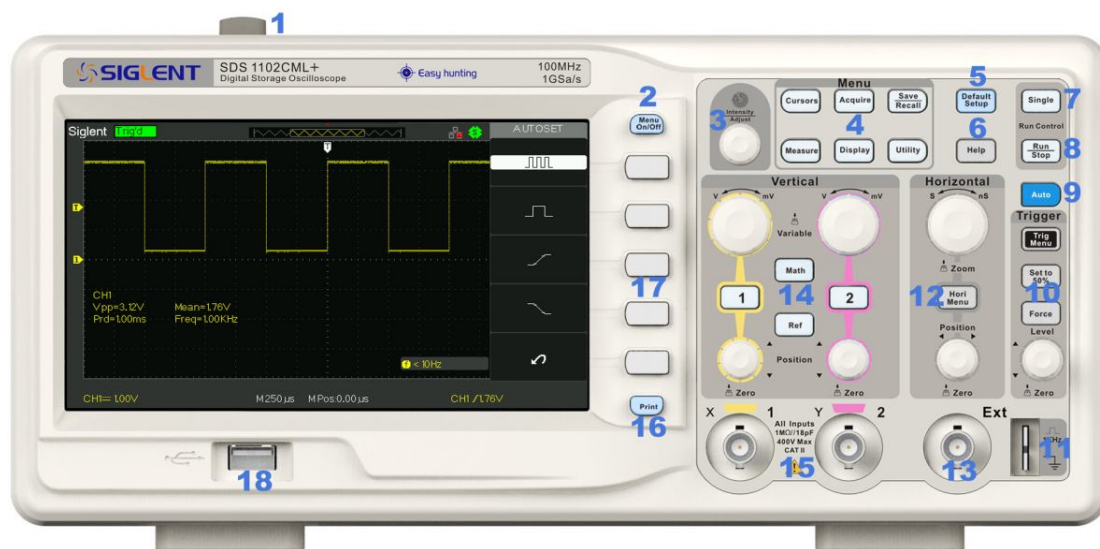

No.	Description	No.	Description
1	Power On/Off	10	Trigger Control Area
2	Menus On/Off	11	Probe Compensation
3	Universal Knob	12	Horizontal Control Area
4	Function Menus	13	EXT TRIG Terminal
5	Default Setup	14	Vertical Control Area
6	Help	15	Channel Input Terminal
7	Single	16	Menu Select keys
8	Run/Stop	17	Print Key
9	Auto	18	USB Host Interface



## The Rear Panel

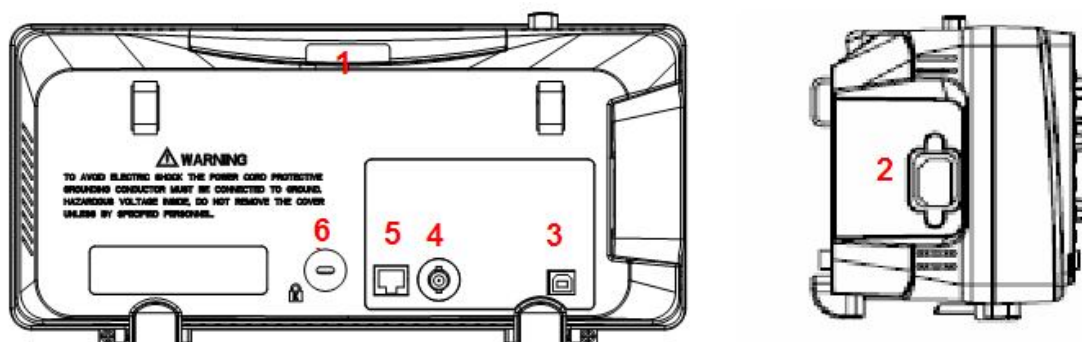

### 1. Handle

Pull up the handle vertically for easy carrying. Press it down if you do not need the handle.

### 2. AC Power Input Terminal

The power available of the oscilloscope is 100~240V, 50/60/440Hz. Please use the power cord provided as accessories to connect the instrument to AC power.

### 3. USB Device Interface

PC can be connected via this interface to print the current interface of the oscilloscope or control the instrument through PC software.

### 4. Pass/Fail Output Terminal

The pass/Fail testing pulse are put out via this terminal.

### 5. LAN Port

The oscilloscope can be controlled through the LAN port.

### 6. Lock hole

You could lock the instrument in a fixed location using a security lock (please buy it yourself) via the lock hole.

# Function Introduction of Front Panel

## Vertical Control

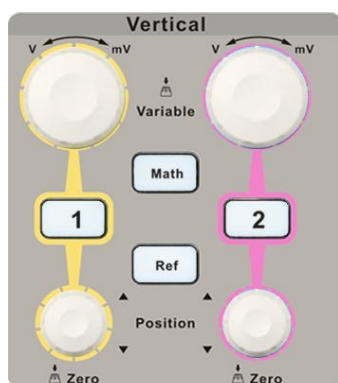

**1** **2** : Input channels. These two channels are marked with different colors to distinguish different input channels and their waveforms. Pressing the channel button will turn on the corresponding channel as well as its menu, and pressing it twice continuously will turn off the channel.

**Math** : Press the button to enable math function which includes five operations: adding, subtracting, multiplying, dividing and FFT.

**Ref** : Press the button to enable the reference waveform function. By recalling the previously saved waveform, we could compare it with the current waveform to decide circuit failures.

 : Modify vertical position of the current waveform. Turn clockwise to increase the position while turn counterclockwise to decrease it. The waveform will move up or down and the position message at the lower-left corner of the screen will change along. Press down the knob to quickly reset the vertical position to zero.



: Modify vertical scale of the current channel. Turn clockwise to decrease the voltage scale while turn counterclockwise to increase it. The amplitude of the waveform will enlarge or reduce and the scale message at the lower-left corner of the screen will also change as the scale changes. Press down the knob to quickly switch the vertical scale adjustment modes between “Coarse” and “Fine”.

## Horizontal Control



**Hori Menu**: Press the button to open horizontal control menu under which you can turn on/off the delay sweep function and switch the save modes between “long save” and “normal save”.



: Modify the trigger position. The trigger point will move left or right relative to the center of the screen when you adjust the knob. The waveform will move left or right and the trigger position message at the lower-left corner of the screen will also change as the position changes. Press the knob to quickly reset the trigger position to zero.



: Modify the horizontal time base. Turn it clockwise or counterclockwise to decrease or increase the time base. The waveform will display expanded or compressed and the time base message at the nether side of the screen will change as the time base changes. Press down the knob to quickly switch to the delay sweep state.

## Trigger Control



**Trig Menu** : Press the button to open trigger menu under which five trigger modes are supported.

**Set to 50%** : Press the button to set trigger level to the middle of the maximal voltage and the minimal voltage to quickly stabilize the current waveform.

**Force** : Press the button to make the signal trigger forcefully.



: Modify the trigger level. Turn it clockwise or counterclockwise to increase or decrease the level. The trigger level will move up or down and the value in the message box at the lower-left corner of the screen will change as the trigger level changes. Press it down to reset the trigger level to the screen vertical center.

## RUN/STOP

 : Press the button to set the state of the instrument to “RUN” or “STOP”.

When in “RUN”, the indicator light displays yellow;  
When in “STOP”, it displays red.

## SINGLE

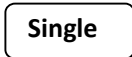
 : Press the button to turn the trigger mode to “Single”.

## AUTO

 : Press the button to enable the waveform auto setting function. The oscilloscope will automatically adjust the horizontal time base, vertical scale and trigger mode according to the input signal to make the waveform displays in a perfect state.

## Universal Knob



**Adjust waveform brightness** While the light above the knob is dark, adjusting the knob will change the waveform brightness, which ranges from 30%~100%. Turning clockwise means increase while counterclockwise means decrease. You can also select “intensity” in “DISPLAY” menu and then adjust the knob to change the waveform brightness.

**Universal knob** When the light above the knob is lighted, you could select anyone submenu by adjusting the knob under the current menu. In addition, it can also be used to modify parameters and input filename.

## Function Menus

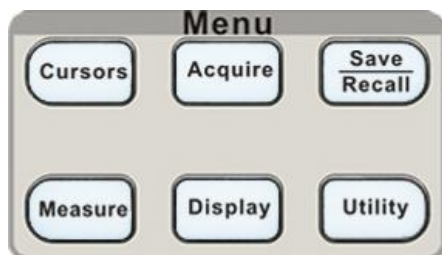

**Cursors** : Press the button to enter the cursor measurement function menu. The instrument provides three measure modes: Manual, Track and Auto.

**Acquire** : Press the button to enter the acquire function menu, under which you could set the acquisition mode, sampling mode and dot inserting mode.

**Save Recall** : Press the button to enter the file save and recall function menu. There are four types of file to be saved which are respectively setups, waveforms, picture and CSV, and additionally the factory setup are supported.

**Measure** : Press the button to enter the measurement function menu. There are three measure types: voltage, time and delay. Each kind of them contains many measurement parameters, you could press any of them to display the corresponding value.

**Display** : Press the button to enter the display function menu, under which you could set waveform display type, persist time, waveform brightness, display format, menu display and so on.

**Utility** : Press the button to enter the utility function menu, under which you could set the corresponding function of the system, some parameters like Sound, Language, Interface and so on. In addition, some advanced functions are also supported such as Self Calibration, Firmware Update, Pass/Fail test.

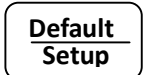

## DEFAULT SETUP

 : Press the button to restore the oscilloscope to its default settings. The default voltage scale and time base are respectively 1v/div and 500us.

## HELP Information

 : Press the button to enable HELP function, and then press down any menu to display corresponding help information. To display the submenus help information of the current menu, firstly you should open the current menu, and then press down the “HELP” button, the last step is to select any submenu you want.

## PRINT

 : Press the button to enable print function. If the instrument is connected to a printer which is usable, press it to perform print function.

# User Interface

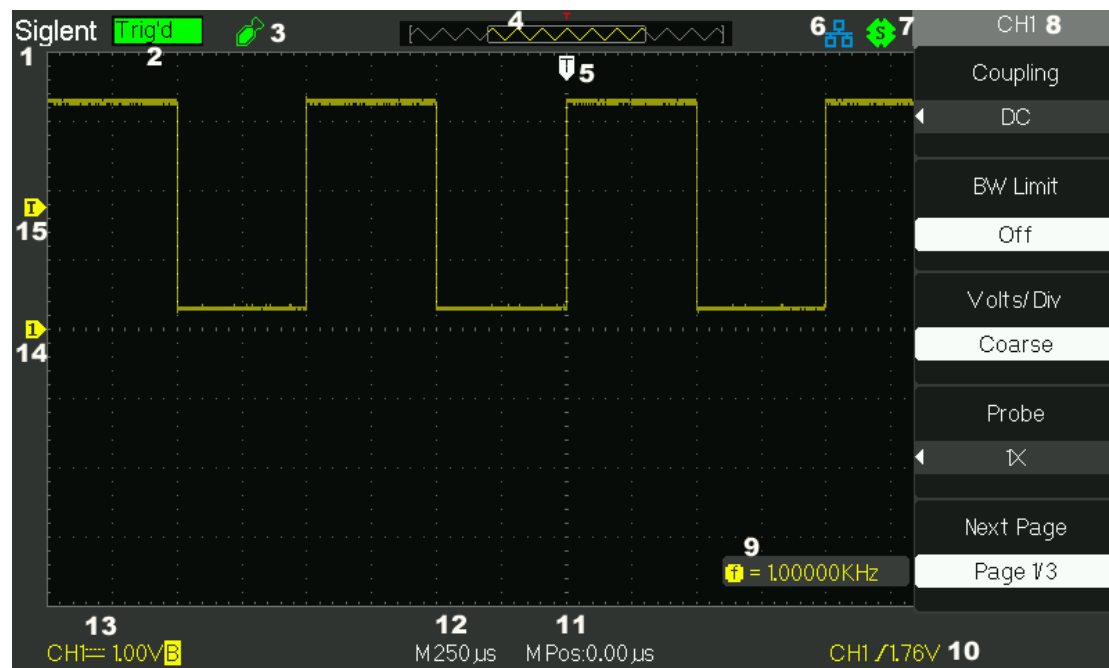

## 1. Product logo

**SIGLENT** is the registered trademark of our company.

## 2. Working state

Available working states include Ready, Auto, Trig'd, Scan and Stop.

## 3. USB Host connection identifier

When the USB Host is connected, the identifier is shown.

## 4. Waveform memory

Display the position of the current waveform in the memory of the oscilloscope.

## 5. Trigger position

Display the trigger position of the waveform in the memory and on the screen.

## 6. LAN Port connection identifier

: indicates the LAN port is connected successfully

: indicates the LAN port is disconnected

## 7. Print function identifier

 indicates the print button set to save function



## 8. Channel identifier

Show the current enabled channel

## 9. Frequency Counter

Display the firmware frequency of current waveform. To display it, you should turn on the “Counter” in menu of “UTILITY”.

## 10. Trigger Parameter

- **Trigger Level.** Display the position of the current trigger level, for example: ;
- **Trigger Type.** Display the current trigger type and trigger condition. Different trigger types have different marks, for example:  means triggered on Slope side in edge trigger.

## 11. Trigger Delay Position

Use **HORIZONTAL POSITION Knob** to modify the parameter. Turn clockwise or counterclockwise to make the red arrowhead move right or left, which will respectively cause the decrease and increase of the parameter in the message box at the lower-left corner of the screen. Press down the knob to automatically reset the parameter to zero as well as make the red arrowhead return to its initial position.

## 12. Horizontal Timebase

Represent the time of each grid on the horizontal axis of the screen. You could revolve **HORIZONTAL SCALE Knob** to modify the parameter which is variable from 2.5nS to 50S.

## 13. Channel Parameter

 If the current “BW Limit” is “On”, then the mark displays at the lower-corner of the screen, or nothing displays.

 indicates the voltage value of each grid on the vertical axis of the screen. You could revolve **VOLTAGE SCALE Knob** to modify the parameter which is variable from 2mV to 10V.

 coupling Mode. The oscilloscope supports three coupling mode: DC, AC and GND.

**14. Channel offset**

Display the offset value of current working channel.

**15. Trigger Level**

Display the position of the trigger level. Turn the knob clockwise or counterclockwise to make the trigger level move up or down.

## Using Security Lock

If needed, you could use the security lock (please buy it yourself) to lock the instrument in a fixed location. The method: align the clock with the clock hole and plug it into the lock hole vertically, turn the key clockwise to lock the instrument and then pull the key out.

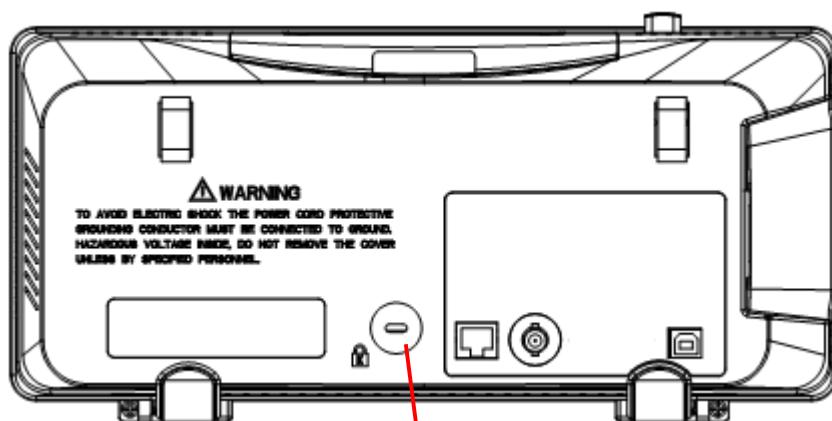

Security lock hole

# Troubleshooting

The general failures and consequential solutions are listed below. When you find them, please deal with them in the following corresponding ways. If the problem proves to be unsolvable yourself, please contact with **SIGLENT** as soon as possible.

## 1. The screen remains dark after power on:

- (1) Check if the power is correctly connected.
- (2) Check whether the fuse is burned out. If the fuse needs to be changed, please contact with **SIGLENT** as soon as possible and return the instrument to the factory to have it repaired by qualified personnel authorized by **SIGLENT**.
- (3) Restart the instrument after completing inspections above.
- (4) If it still does not work normally, please contact **SIGLENT**.

## 2. After the signal is sampled, there is no corresponding waveform displaying:

- (1) Check if the probe is correctly connected to the signal connecting cord.
- (2) Check if the signal connecting cord is correctly connected to BNC connector.
- (3) Check if the probe is correctly connected to the item under test.
- (4) Check if there are signal generated from the item under test (you can connect the probe compensation signal to the problematic channel to determine the reason to the problem )
- (5) Resample the signal.

**3. The voltage amplitude measured is higher or lower than the actual value (the error usually occurs in use of the probe):**

Check if the attenuation coefficient of the current channel matches with the attenuation ratio of the probe.

**4. There is waveform displaying but not stable:**

- (1) Check the trigger source: check whether the “Source” in menu of “TRIG” is the actual operating channel.
- (2) Check if the waveform is false: it is easy for us to regard the false waveform as the real when a high frequency signal is connected to the instrument. You’d better make sure that the current time base is correct.
- (3) Check the trigger type: “Edge” trigger suits to general signal and “Video” trigger suits to video signal. Only in correct trigger type can the waveform stably display.
- (4) Change the setting of trigger holdoff.

**5. No display after pressing  :**

Check whether the trigger Mode is “Normal” or “Single”, and if the trigger level exceeds the waveform range. If yes, set the trigger level to the vertical center or change the trigger Mode to “Auto”.

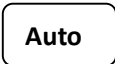
Note: press  could automatically replace the above setting.

**6. The waveform displays like ladder:**

- (1) The horizontal time base may be too low, you can increase it to improve the horizontal resolution so as to make a good waveform displaying.
- (2) The lines between the sample points may also cause ladder-like displaying if the “Type” in menu of “DISPLAY” is “Vectors”. Please turn the “Type” to “Dots” to solve the problem.

## 7. USB storage can't be recognized:

- (1) Check if the U disk can work normally.
- (2) Make sure that the U disk being used is of flash type, the instrument does not support USB of hardware type.
- (3) Make sure that the capacity of the U disk is not too large. It is suggested that the capacity is no larger than 4 G.
- (4) Restart the instrument and then insert the U disk to check.
- (5) If it is still in abnormal use, please contact **SIGLENT**.

### Teléfonos / Phone number

Mex: +52 (33)-3854-5975  
+52 (33)-3823-4349  
USA: +1 (619) 619-7350

### Página Web / Website

tienda.logicbus.com.mx  
logicbus.com

### Correo electrónico / E-mail

ventas@logicbus.com  
sales@logicbus.com



### Dirección / Address

Av. Fray Antonio Alcalde 1822  
Miraflores, 44270  
Guadalajara, Jal



8280 Clairemont Mesa Blvd  
Suite 122  
San Diego, CA 92111

