

ENGLISH



ENGLISH



ENGLISH



ENGLISH

Installation and User Manual

version 1.07

TLB4

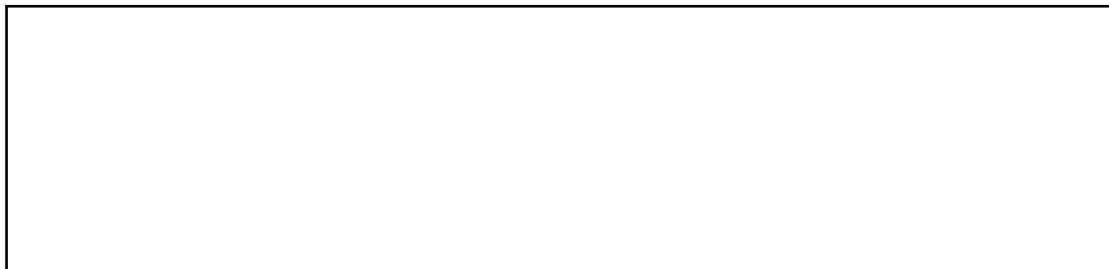

SYMBOLS

Here are the symbols used in the manual to draw the reader's attention:



Caution! Risk of electric shock.



Caution! This operation must be performed by skilled personnel.



Pay particular attention to the following instructions.



Further information.

WARRANTY

24 months from the date of the delivery note. Warranty covers only failures of defective components (due to construction defects or defects in materials) and includes replacement or repair of the components and related labor costs.

Warranty is automatically forfeited in the event of:

- tampering, deletion, removal of the identification label and/or serial number of the product
- misuse, transformation, alteration, repair of products not carried out by Laumas personnel

Laumas provides a 1-year warranty from the date of the delivery note on defects in material or manufacture of the battery.

GUIDELINES FOR PROPER DISPOSAL



**Sealed Lead Acid
Battery
Must be recycled
Properly**

This symbol on the product or packaging indicates that:

- This is electrical/electronic equipment and cannot be disposed of as municipal solid waste, but must be delivered to a recycling center
- Improper use or disposal can pollute the environment or damage human health
- Non-compliance with these guidelines will be penalized in accordance with the regulations in force in the country of destination
- It is recommended to dispose of the packing and packaging as required by local regulations

TABLE OF CONTENTS

USER WARNINGS	1
RECOMMENDATIONS FOR CORRECT INSTALLATION OF WEIGHING INSTRUMENTS .	1
RECOMMENDATIONS FOR CORRECT INSTALLATION OF THE LOAD CELLS	2
LOAD CELL INPUT TEST (QUICK ACCESS)	4
LOAD CELL TESTING	4
MAIN SPECIFICATIONS OF THE INSTRUMENT	5
TECHNICAL SPECIFICATIONS	6
ELECTRICAL CONNECTIONS	7
BASIC INFORMATION.....	7
WIRING DIAGRAM.....	7
LED AND KEYS FUNCTIONS	9
MENU MAP	10
SETPOINT (BASE program)	10
SYSTEM PARAMETERS (BASE program).....	10
SYSTEM PARAMETERS (LOAD program).....	12
BATCHING CONSTANTS (LOAD program)	14
INSTRUMENT COMMISSIONING	15
PROGRAMMING OF SYSTEM PARAMETERS	17
THEORETICAL CALIBRATION	17
<i>MAXIMUM CAPACITY (BASE program)</i>	18
<i>TARE WEIGHT ZERO SETTING</i>	18
<i>ZERO VALUE MANUAL ENTRY</i>	19
REAL CALIBRATION (WITH SAMPLE WEIGHTS).....	20
STABILITY	21
CONFIRMATION AND CHANGE OF ACTIVE CHANNELS.....	21
EQUALIZATION	22
FILTER ON THE WEIGHT	23
<i>ANTI PEAK</i>	24
ZERO PARAMETERS	24
<i>RESETTABLE WEIGHT SETTING FOR SMALL WEIGHT CHANGES</i>	24
<i>AUTOMATIC ZERO SETTING AT POWER-ON</i>	24
<i>ZERO TRACKING</i>	24
SETTING UNITS OF MEASURE	25
<i>DISPLAY COEFFICIENT (BASE program)</i>	25
OUTPUTS AND INPUTS CONFIGURATION (BASE program).....	27
OUTPUTS AND INPUTS CONFIGURATION (LOAD program)	28
SEMI-AUTOMATIC TARE (NET/GROSS).....	29
PRESET TARE (SUBTRACTIVE TARE DEVICE)	30
SEMI-AUTOMATIC ZERO (WEIGHT ZERO-SETTING FOR SMALL VARIATIONS)	30
PEAK (BASE program)	31
ANALOG OUTPUT (TLB4 ONLY).....	31

SERIAL COMMUNICATION SETTING	33
<i>RS485 SERIAL COMMUNICATION</i>	35
<i>DIRECT CONNECTION BETWEEN RS485 AND RS232 WITHOUT CONVERTER</i>	35
AUTOMATIC DIAGNOSTICS OF LOAD DISTRIBUTION.....	36
TEST.....	37
EVENTS LOG.....	38
INFO MENU.....	38
SETPOINT PROGRAMMING (BASE program)	39
USE WITH W SERIES INSTRUMENTS (BASE program).....	40
CONNECTION TO THE WEIGHT INDICATOR.....	40
ADDITIONAL MENU MAP.....	41
TLB4 REMOTE CONTROL	42
<i>REMOTE KEYPAD LOCKING</i>	42
ADDITIONAL ALARMS.....	42
ALARMS	43
BATCHING (LOAD program).....	45
INTRODUCTION TO THE OPERATION	45
BATCHING SEQUENCE	45
<i>BATCHING SEQUENCE PROGRAMMING</i>	45
<i>BATCHING START</i>	46
<i>BATCHING EXECUTION</i>	46
<i>WAITING PHASE</i>	47
<i>CYCLE END PHASE</i>	47
OPERATION SETTINGS	48
DISPLAYING DURING BATCHING	48
BATCHING STOP	48
CONSUMPTION	49
<i>CONSUMPTION DELETION</i>	49
PROGRAMMING OF BATCHING CONSTANTS	49
<i>MINIMUM WEIGHT</i>	49
<i>MAXIMUM WEIGHT</i>	49
<i>SAFE EMPTYING TIME</i>	50
<i>WAITING TIME</i>	50
<i>NO COMPARISON TIME</i>	50
<i>NO PRODUCT LOAD TIME</i>	50
<i>NO PRODUCT UNLOAD TIME</i>	50
<i>FALL</i>	51
<i>TOLERANCE</i>	52
<i>SLOW</i>	52
<i>TAPPING FUNCTION</i>	52
<i>AUTOTARE</i>	52
<i>AUTOTARE DELAY</i>	53
<i>STABLE TARE</i>	53
<i>CONSUMPTION</i>	53
<i>PRINT AT CYCLE END</i>	53
<i>NUMBER OF BATCHING PRINTOUTS</i>	53

<i>WAITING CONFIRMATION FROM PC (SLAVE)</i>	53
FORMULA PROGRAMMING	54
<i>DELETING FORMULA</i>	54
ADDITIONAL ALARMS RELATING TO BATCHING	55
PRINTING EXAMPLES	56
FRONT PANEL MOUNTING	60
RESERVED FOR THE INSTALLER.....	61
MENU LOCKING	61
MENU UNLOCKING.....	61
TEMPORARY MENU UNLOCKING	61
DATA DELETION AND PROGRAM SELECTION	61
KEYPAD OR DISPLAY LOCKING.....	62
DECLARATION OF CONFORMITY - EU.....	63
DECLARATION OF CONFORMITY - UKCA.....	64

USER WARNINGS

RECOMMENDATIONS FOR THE PROPER USE OF WEIGHING INSTRUMENT

- Keep away from heat sources and direct sunlight
- Repair the instrument from rain (except special IP versions)
- Do not wash with water jets (except special IP versions)
- Do not dip in water
- Do not spill liquid on the instrument
- Do not use solvents to clean the instrument
- Do not install in areas subject to explosion hazard (except special Atex versions)
- If the working temperature reaches the permitted limits, it is advisable to distance the instruments to ensure adequate air flow and avoid malfunctions (e.g.: sudden shutdowns or disconnections)

RECOMMENDATIONS FOR CORRECT INSTALLATION OF WEIGHING INSTRUMENTS

The terminals indicated on the instrument's wiring diagram to be connected to earth must have the same potential as the weighed structure (same earthing pit or earthing system). If you are unable to ensure this condition, connect with an earthing wire the terminals of the instrument (including the terminal –SUPPLY) to the weighed structure.

The cell cable must be individually led to its panel input and not share a conduit with other cables; connect it directly to the instrument terminal strip without breaking its route with support terminal strips.

Use "RC" filters on the instrument-driven solenoid valve and remote control switch coils.

Avoid inverters in the instrument panel; if inevitable, use special filters for the inverters and separate them with sheet metal partitions.

The panel installer must provide electric protections for the instruments (fuses, door lock switch etc.).

It is advisable to leave the equipment always switched on to prevent the formation of condensation.

MAXIMUM CABLE LENGTHS

- RS485: 1000 metres with AWG24, shielded and twisted cables
- Analog current output: up to 500 metres with 0.5 mm² cable
- Analog voltage output: up to 300 metres with 0.5 mm² cable

RECOMMENDATIONS FOR CORRECT INSTALLATION OF THE LOAD CELLS

SIZING OF LOAD CELLS CAPACITY

For safety reasons, in case of static weighing, it is advisable to use the load cells at a maximum of 70-80% of its nominal capacity (assuming that the load is uniformly distributed over the entire weighed structure); depending on the handling mode of the load to weigh, consider to further reduce the % of load with respect to the nominal capacity (ex.: forklifts handling, bridge cranes, etc.).

In case of weighing with dynamic loads, the installer has to estimate the thrust speed, the acceleration, the frequency, etc.

INSTALLING LOAD CELLS

The load cells must be placed on rigid, stable in-line structures; it is important to use the mounting modules for load cells to compensate for misalignment of the support surfaces.

PROTECTION OF THE CELL CABLE

Use water-proof sheaths and joints in order to protect the cables of the cells.

MECHANICAL RESTRAINTS (pipes, etc.)

When pipes are present, we recommend the use of hoses and flexible couplings with open mouthpieces with rubber protection; in case of hard pipes, place the pipe support or anchor bracket as far as possible from the weighed structure (at a distance at least 40 times the diameter of the pipe).

WELDING

Avoid welding with the load cells already installed. If this cannot be avoided, place the welder ground clamp close to the required welding point to prevent sending current through the load cell body.

WINDY CONDITIONS - KNOCKS – VIBRATIONS

The use of weigh modules is strongly recommended for all load cells to compensate for misalignment of the support surfaces. The system designer must ensure that the plant is protected against lateral shifting and tipping relating to: shocks and vibration; windy conditions; seismic conditions in the installation setting; stability of the support structure.

EARTHING THE WEIGHED STRUCTURE

By means of a copper wire with suitable cross-section, connect the cell upper support plate with the lower support plate, then connect all the lower plates to a single earthing system. Electrostatic charges accumulated because of the product rubbing against the pipes and the weighed container walls are discharged to the ground without going through or damaging the load cells. Failure to implement a proper earthing system might not affect the operation of the weighing system; this, however, does not rule out the possibility that the cells and connected instrument may become damaged in the future. It is forbidden to ensure earthing system continuity by using metal parts contained in the weighed structure.

FAILURE TO FOLLOW THE INSTALLATION RECOMMENDATIONS WILL BE CONSIDERED A MISUSE OF THE EQUIPMENT

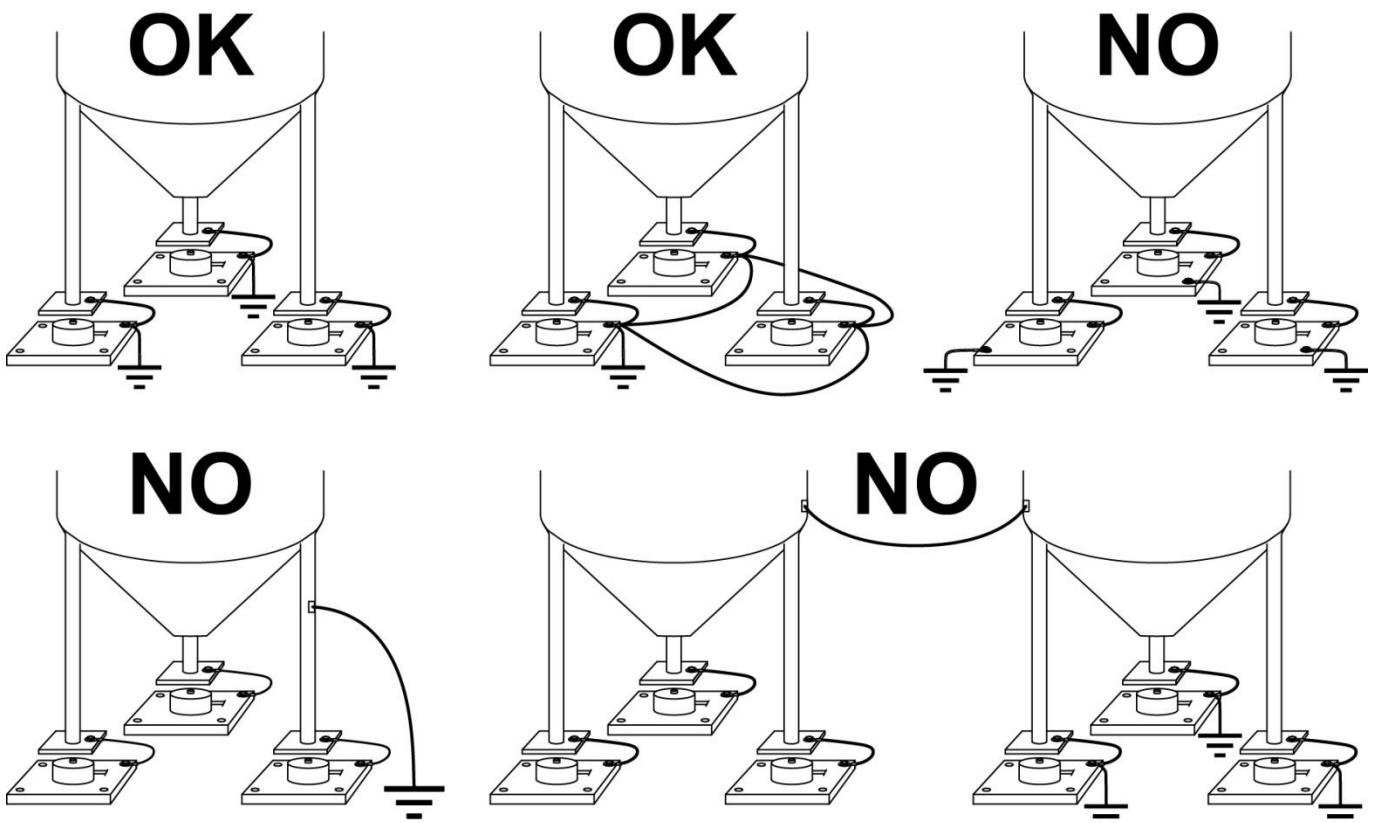

LOAD CELL INPUT TEST (QUICK ACCESS)

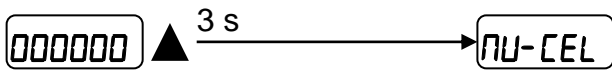

From the weight display, press ▲ for 3 seconds: the display shows the response signal of each load cell (CH 1 ÷ CH 4) expressed in mV with three decimals.

Example: a load cell with 2.000 mV/V sensitivity provides a response signal between 0 and 10 mV.

LOAD CELL TESTING

Load cell resistance measurement (use a digital multimeter):

- Turn off the instrument.
- The value between the positive signal wire and the negative signal wire must be equal or similar to the one indicated in the load cell data sheet (output resistance).
- The value between the positive excitation wire and the negative excitation wire must be equal or similar to the one indicated in the load cell data sheet (input resistance).

Load cell voltage measurement (use a digital multimeter):

- Turn on the instrument.
- Take out the load cell to be tested from underneath the container, or alternatively, lift the container support.
- Make sure that the excitation of two wires of the load cell connected to the instrument (or amplifier) is 5 VDC \pm 3%.
- Measure the response signal between the positive and the negative signal wires by directly connecting them to the tester, and make sure that it is comprised between 0 and \pm 0.5 mV.
- Apply load to the cell and make sure that there is a signal increment.

IF ONE OF THE ABOVE CONDITIONS IS NOT MET, PLEASE CONTACT THE TECHNICAL ASSISTANCE SERVICE.

MAIN SPECIFICATIONS OF THE INSTRUMENT

Weight transmitter with 6-wire load cells inputs suitable for assembly on back panel fitted Omega/DIN rail or on front panel using the included mounting kit. Dimensions: 26x115x120 mm. Six-digit semialphanumeric display, 8 mm height, 7 segment. Four-key keyboard.

RS485 serial port for connection to: PC/PLC up to 32 instruments (max 99 with line repeaters) by ASCII Laumas or ModBus R.T.U. protocol, remote display, printer. Optional: integrated Profibus DP, DeviceNet, CANopen, Profinet IO, Ethernet/IP, Ethernet TCP/IP, Modbus TCP, RS232/RS485, SERCOS III, PowerLink, CC-Link output.

TLB4 only: optoisolated 16 bit analog output (tension or current).

4 independent channels: automatic detection of connected load cells.

Digital equalization: load cell response uniformed via software.

Load distribution: indication of the weight percentage on each load cell.

Automatic diagnostics: load distribution check to detect any faults.

Events log: storage of the last 50 events: calibrations, zero-settings, errors, equalizations.

Alarm Relay: outputs can be set to switch in case of alarm.

TECHNICAL SPECIFICATIONS

POWER SUPPLY and CONSUMPTION	12/24 VDC \pm 10%; 5 W
No. OF LOAD CELLS IN PARALLEL and SUPPLY	max 16 (350 ohm); 5 VDC/240 mA
LINEARITY	< 0.01% F.S.
ANALOG OUTPUT LINEARITY (TLB4 only)	< 0.01% F.S.
THERMAL DRIFT	< 0.0005% F.S./ $^{\circ}$ C
ANALOG OUTPUT THERMAL DRIFT (TLB4 only)	< 0.003 % F.S./ $^{\circ}$ C
A/D CONVERTER	4 channels, 24 bit (16000000 points), 4.8 kHz
DIVISIONS (with measurement range \pm 10 mV = sens. 2 mV/V)	\pm 999999
MEASUREMENT RANGE	\pm 39 mV
MAX SENSITIVITY OF USABLE LOAD CELLS	\pm 7 mV/V
MAX CONVERSIONS PER SECOND	600 conversions/second
DISPLAY RANGE	\pm 999999
NO. OF DECIMALS / DISPLAY INCREMENTS	0 \div 4 / x 1 x 2 x 5 x 10 x 20 x 50 x 100
DIGITAL FILTER / READINGS PER SECOND	21 levels / 5 \div 600 Hz
RELAY OUTPUTS	N. 3 - max 115 VAC; 150 mA
DIGITAL INPUTS	N. 2 - optoisolated 5 - 24 VDC PNP
SERIAL PORTS	RS485
BAUD RATE	2400, 4800, 9600, 19200, 38400, 115200
HUMIDITY (non condensing)	85%
STORAGE TEMPERATURE	-30 $^{\circ}$ C +80 $^{\circ}$ C
WORKING TEMPERATURE	-20 $^{\circ}$ C +60 $^{\circ}$ C
OPTOISOLATED ANALOG OUTPUT (TLB4 only) 16 bit - 65535 divisions	0 \div 20 mA; 4 \div 20 mA (max 300 ohm); 0 \div 10 V; 0 \div 5 V, \pm 10 V; \pm 5 V (min 10 kohm)

	RELAY OUTPUTS	N. 3 - max 30 VAC, 60 VDC; 150 mA
	Equipment to be powered by 12-24 VDC LPS or Class 2 power source.	

ELECTRICAL CONNECTIONS

BASIC INFORMATION

- It is recommended that the power supply negative pole be grounded.
- It is possible to supply up to 16 350 ohm load cells.
- Connect terminal “-SUPPLY” to the RS485 common of the connected instruments in the event that these receive alternating current input or that they have an optically isolated RS485.
- In case of an RS485 network with several devices it is recommended to activate the 120 ohm termination resistance on the two devices located at the ends of the network, as described in the paragraph **RS485 SERIAL CONNECTION**.

WIRING DIAGRAM

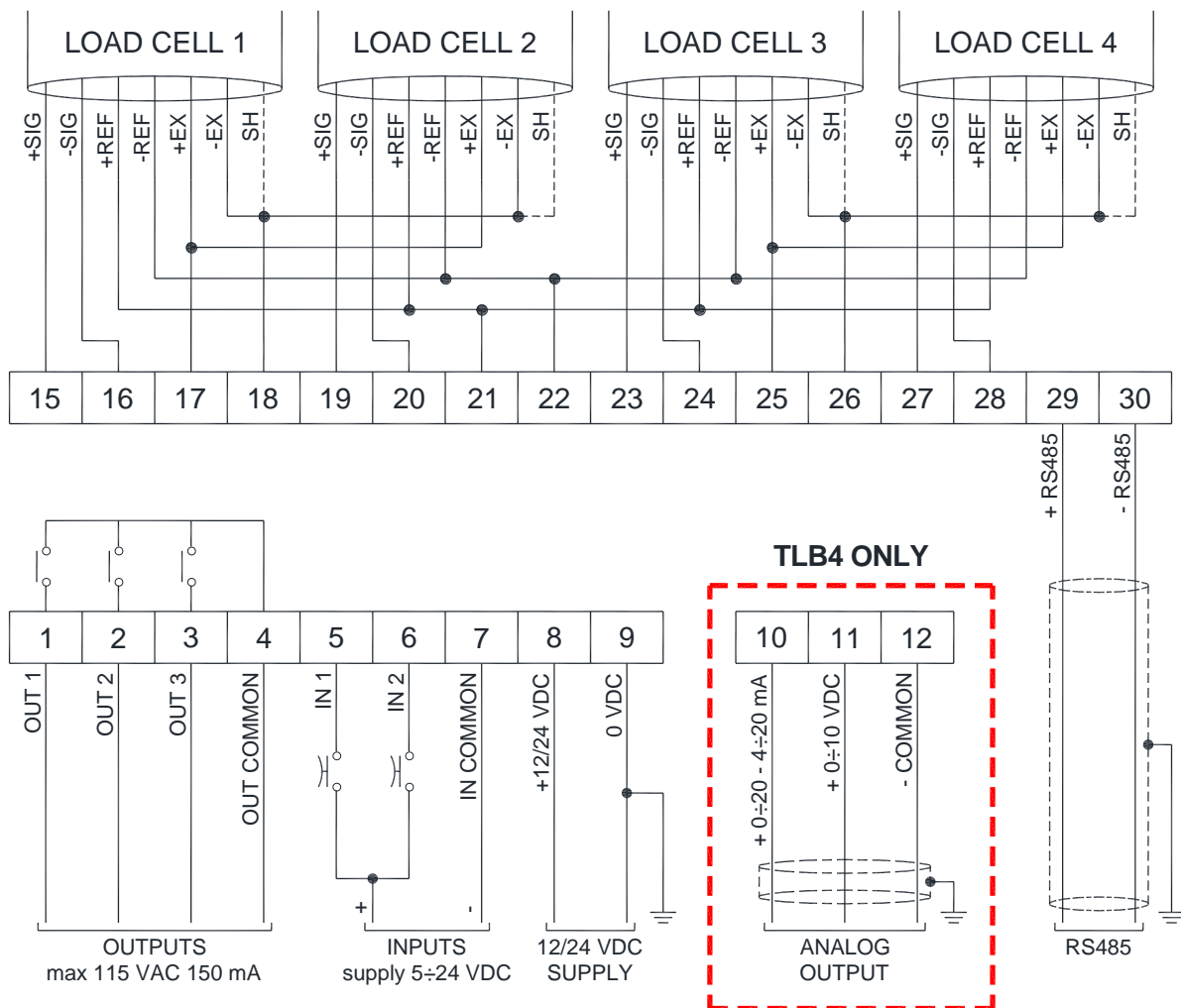

In case of difficulty connecting all the reference wires of the installed load cells, simply connect those of the load cell located at the average distance from the instrument. The reference wires not used must be individually isolated.





USE OF 4-WIRE LOAD CELLS: if all the load cells used are 4-wire, make a jumper between -EX (26) and -REF (22) and between +EX (25) and +REF (21).



TERMINALS LEGEND

1	OUTPUT No. 1	17	+LOAD CELLS 1 and 2 EXCITATION (+EX)
2	OUTPUT No. 2	18	-LOAD CELLS 1 and 2 EXCITATION (-EX) LOAD CELLS SHIELD
3	OUTPUT No. 3	19	+LOAD CELL 2 SIGNAL
4	OUTPUT COMMON	20	-LOAD CELL 2 SIGNAL
5	INPUT No. 1 (+VDC min 5 V max 24 V)	21	+LOAD CELLS REF/SENSE
6	INPUT No. 2 (+VDC min 5 V max 24 V)	22	-LOAD CELLS REF/SENSE
7	INPUT COMMON (-VDC 0 V)	23	+LOAD CELL 3 SIGNAL
8	+SUPPLY (12/24 VDC)	24	-LOAD CELL 3 SIGNAL
9	-SUPPLY (12/24 VDC) RS485: SHIELD, GND	25	+LOAD CELLS 3 and 4 EXCITATION (+EX)
10	+ANALOG OUTPUT 0÷20 or 4÷20 mA (TLB4 only)	26	-LOAD CELLS 3 and 4 EXCITATION (-EX) LOAD CELLS SHIELD
11	+ANALOG OUTPUT 0÷10 V (TLB4 only)	27	+LOAD CELL 4 SIGNAL
12	-ANALOG OUTPUT COMMON (TLB4 only)	28	-LOAD CELL 4 SIGNAL
15	+LOAD CELL 1 SIGNAL	29	RS485: +
16	-LOAD CELL 1 SIGNAL	30	RS485: -

LED AND KEYS FUNCTIONS

LED	Main function	Secondary function *
NET	net weight (semi-automatic tare or preset tare)	LED lit: output 3 closed
→0←	zero (deviation from zero not more than ±0.25 divisions)	LED lit: output 2 closed
▾	stability	LED lit: output 1 closed
kg	unit of measure: kg	
g	unit of measure: g	LED lit: input 2 closed
L	unit of measure other than kg or g	LED lit: input 1 closed

*) To activate the secondary LED function, during weight display press and hold down the keys  and  (press  immediately followed by .

KEY	Short press	Long press (3 s)	Into menus
✕	Semi-automatic zero	Tare resetting	Cancel or return to previous menu
◀	Gross → Net	Net → Gross	Select figure to be modified or go to previous menu item.
▲	Weight print	Gross weight: mV load cell test Net weight: temporarily display the gross weight	Modify selected figure or go to next menu item
↵	Setting setpoint and hysteresis		Confirm or enter in submenu
↵+✕	Setting general parameters (press  immediately followed by ✕)		
↵+◀	Setting preset tare (press  immediately followed by ◀)		



Into menus LEDs light up in sequence to indicate that it is not displaying a weight.

MENU MAP

Into menus changes are applied right after pressing the key (no further confirmation is required).

SETPOINT (BASE program)



SYSTEM PARAMETERS (BASE program)

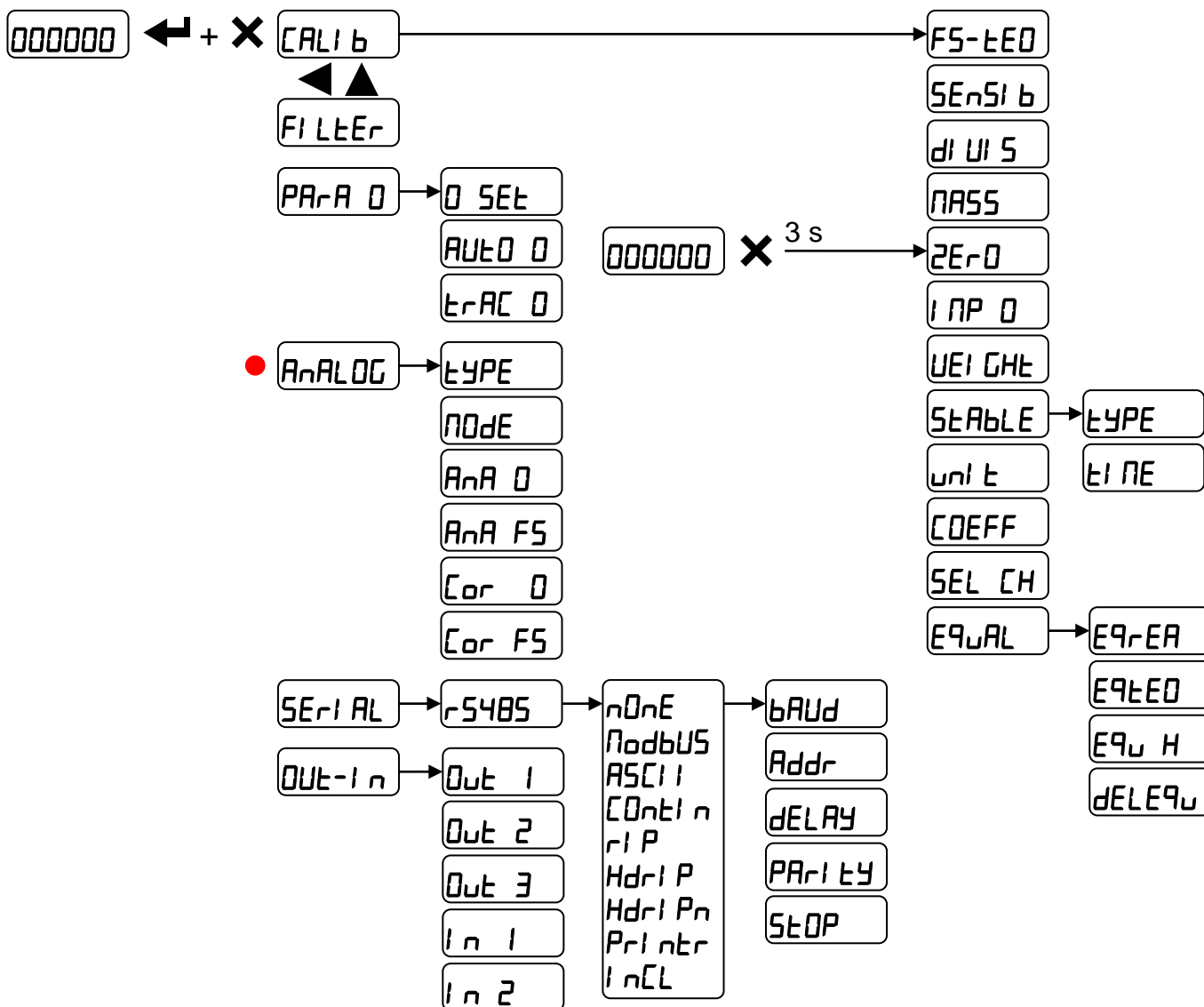

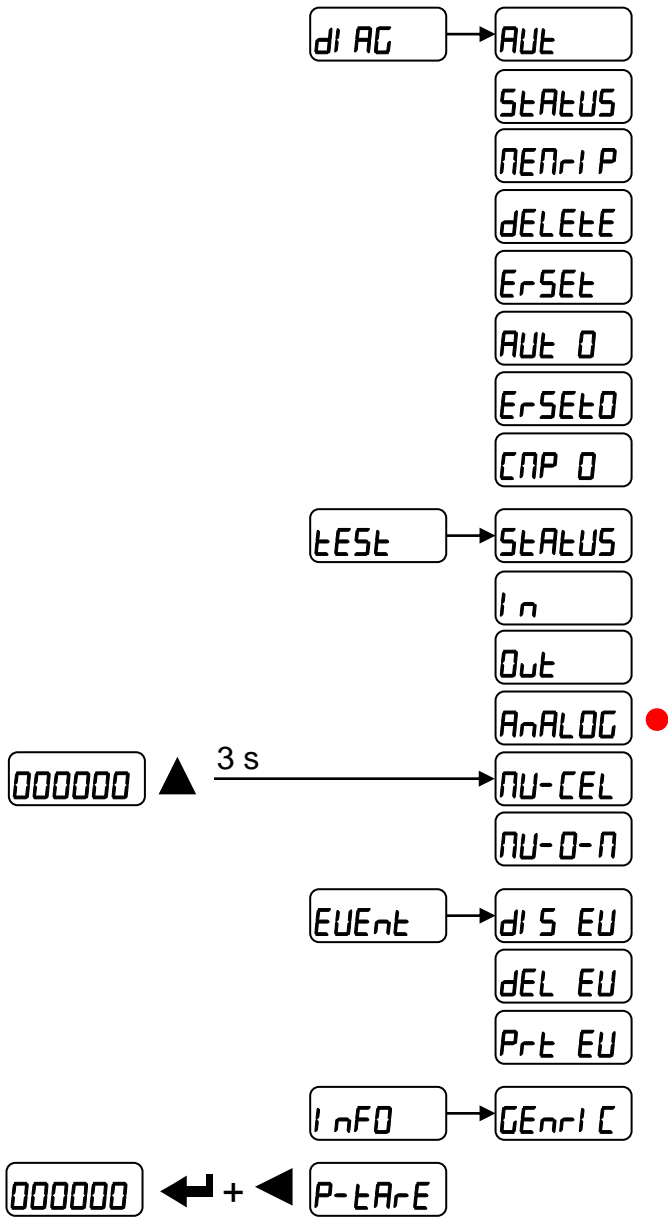

SYSTEM PARAMETERS (LOAD program)

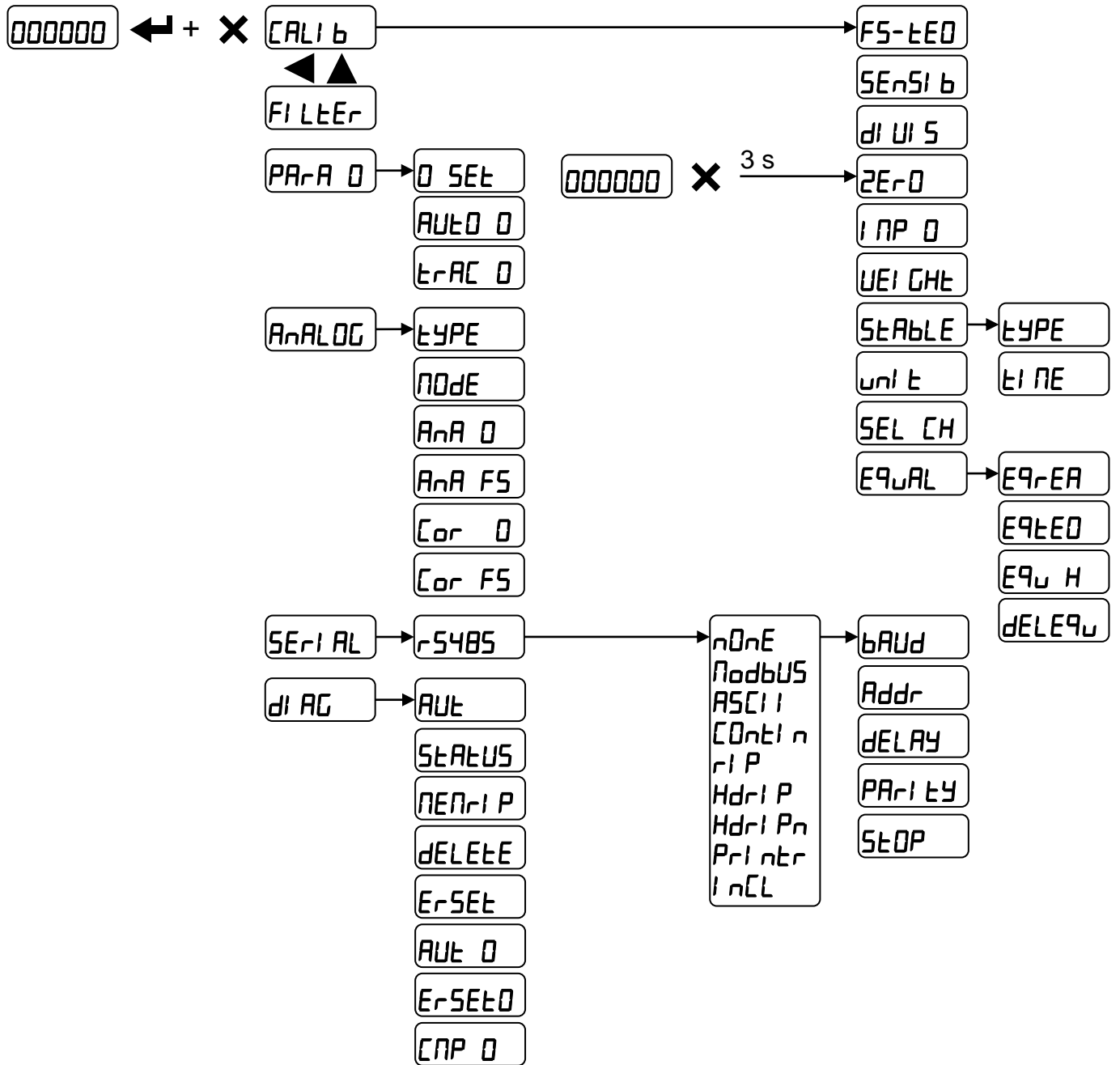

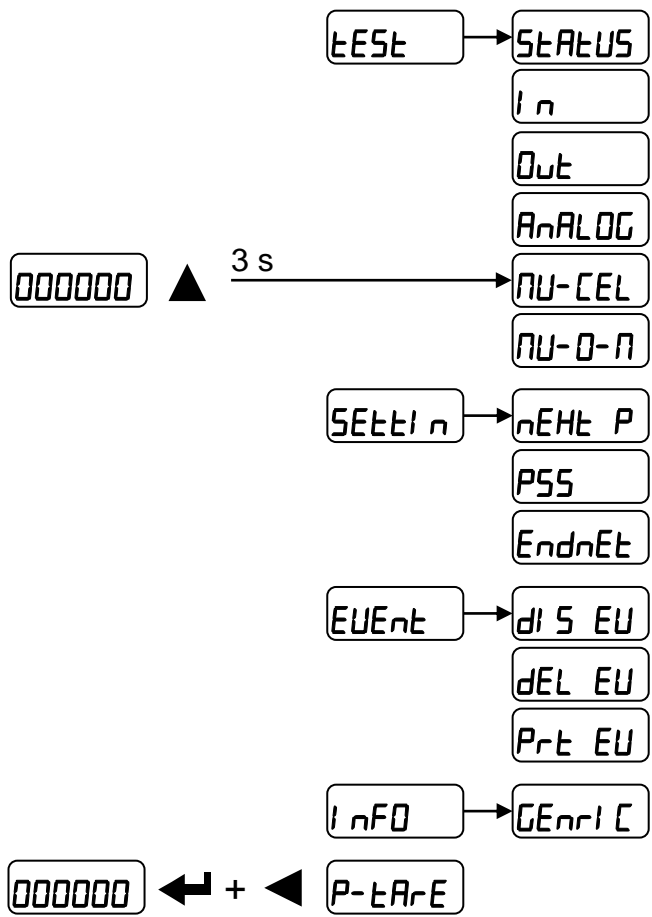

BATCHING CONSTANTS (LOAD program)

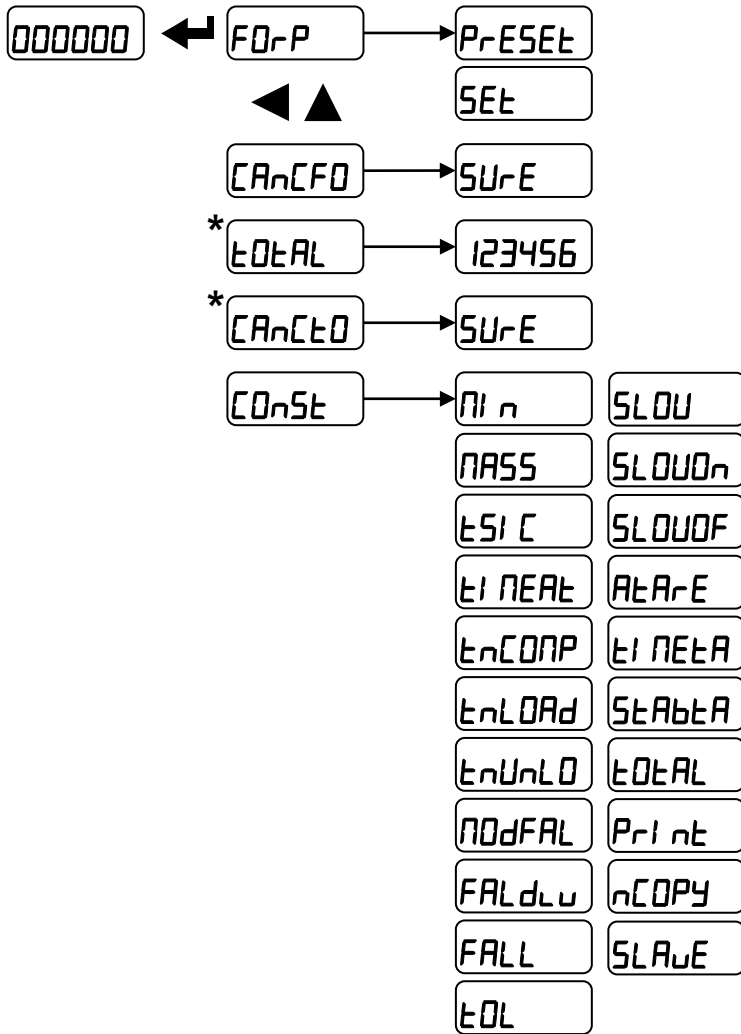

*: it appears only if in constants TOTAL = YES

INSTRUMENT COMMISSIONING

Upon switch-on, the display shows in sequence:

- *111111* → *999999* (ONLY in case of approved program);
- instrument model (e.g.: *ELb4*);
- *SU* followed by the software code (e.g.: *SU 100*);
- program type: *bASE* (base);
- *r* followed by the software version (e.g.: *r 1.04.01*);
- *HU* followed by the hardware code (e.g.: *HU 600*);
- serial number (e.g.: *1005 15*);

Check that the display shows the weight and that when loading the load cells there is an increase in weight. If there is not check and verify the connections and correct positioning of the load cells.

- **If the instrument has already been theoretical CALIBRATED** (plant system identification tag present on the instrument and on the cover: load cell's rated data already entered):
 - If the system uses load cells with different sensitivity perform a real or theoretical equalization (see section **EQUALIZATION**).
 - Reset to zero (see section **TARE WEIGHT ZERO SETTING**).
 - Check the calibration with sample weights and correct the indicated weight if necessary (see section **REAL CALIBRATION (WITH SAMPLE WEIGHTS)**).

- **If the instrument HAS NOT BEEN CALIBRATED** (missing plant system identification tag) proceed with calibration:
 - If the system uses load cells with different sensitivity perform a real or theoretical equalization (see section **EQUALIZATION**).
 - If load cells data are unknown, follow the procedure in section **REAL CALIBRATION (WITH SAMPLE WEIGHTS)**.
 - Enter the rated data of load cells following the procedure given in section **THEORETICAL CALIBRATION**.
 - Reset to zero (see section **TARE WEIGHT ZERO SETTING**).
 - Check the calibration with sample weights and correct the indicated weight if necessary (see section **REAL CALIBRATION (WITH SAMPLE WEIGHTS)**).

- If you use the analog output, set the desired analog output type and the full scale value (see section **ANALOG OUTPUT**).
- If you use serial communication, set the related parameters (see section **SERIAL COMMUNICATION SETTING**).

BASE PROGRAM ONLY

- If setpoint are used, set the required weight values and the relevant parameters (see sections **SETPOINT PROGRAMMING (BASE program)** and **OUTPUTS AND INPUTS CONFIGURATION (BASE program)**).





LOAD PROGRAM ONLY

Required settings for the first batching:









- set the minimum weight value (see section **MINIMUM WEIGHT**);
- set the *P55* parameter (see section **OPERATION SETTINGS**);
- set the formula (see section **FORMULA PROGRAMMING**);
- start the batching by closing the START contact or remotely.

PROGRAMMING OF SYSTEM PARAMETERS

From the weight display, press simultaneously keys  and  to access the parameter setting.

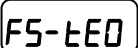
- : to enter a menu/confirm the data entry.
- : to modify the displayed figure or menu item.
- : to select a new figure or modify the displayed menu item.
- : to cancel and return to the previous menu.

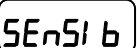
THEORETICAL CALIBRATION

  +        

This function allows the load cell rated values to be set.

To perform the theoretical calibration set the following parameters in sequence:

- **FS-LEO** (default: $dEN0$): the **system full scale** is given by one cell capacity multiplied by the number of cells used. Example: 4 cells of 1000 kg \rightarrow FULL SCALE = 1000 x 4 = 4000. The instrument is supplied with a theoretical full scale value $dEN0$ corresponding to 10000. To restore factory values, set 0 as full scale.
- **SEnSi b** (default: 2.00000 mV/V): **sensitivity** is a load cell rated parameter expressed in mV/V. Set the average sensitivity value indicated on the load cells. It's possible to set a value between 0.50000 and 7.00000 mV/V. Example of 4-cell system with sensitivity: 2.00100, 2.00150, 2.00200, 2.00250; enter 2.00175, calculated as $(2.00100 + 2.00150 + 2.00200 + 2.00250) / 4$.
- **dI UI S**: the **division** (resolution) is the minimum weight increment value which can be displayed. It is automatically calculated by the system according to the performed calibration, so that it is equal to 1/10000 of full scale. It can be changed and be variable between 0.0001 and 100 with x1 x2 x5 x10 increments.



- By modifying the theoretical full scale or the sensitivity, the real calibration is cancelled and the theoretical calibration only is considered valid.
- If the theoretical full scale and the recalculated full scale in real calibration (see section **REAL CALIBRATION (WITH SAMPLE WEIGHTS)**) are equal, this means that the calibration currently in use is theoretical; if they are different, the calibration in use is the real calibration based on sample weights.
- By modifying the theoretical full scale or the sensitivity, the system's parameters containing a weight value will be set to default values (setpoint, hysteresis, etc.).

MAXIMUM CAPACITY (BASE program)

000000 ← + × CALIB ← FS-tEO ← ▲ MASS

MASS: maximum displayable weight (from 0 to full scale; default: 0). When the weight exceeds this value by 9 divisions, the display shows ----- . To disable this function, set 0.

TARE WEIGHT ZERO SETTING



000000 ← + × CALIB ← FS-tEO ← ▲ ZErO

This menu may also be accessed directly from the weight display, holding down the  key for 3 seconds.

Perform this procedure after having set the THEORETICAL CALIBRATION data.

Use this function to set to zero the weight of the empty system after commissioning and then later on to compensate zero variations due to the presence of product residues.

Procedure:

- Confirm the message **ZErO** by pressing .
- The weight value to be set to zero is displayed. In this phase all of the LEDs are flashing.
- Confirming once again, the weight is set to zero (the value is stored to the permanent memory).
- Press  to display the value of the total weight reset by the instrument, given by the sum of all of the previous zero settings.

DIAGNOSTICS ON ZERO: if diagnostics on zero has been enabled, the instrument can display and store the load distributions on zero and the mV on active channels (see section **TEST**). If the stored weight is zero and all channels are **OFF**, it means that no zero-setting has yet been performed.



WARNING: diagnostics on zero is performed only if the load distribution has been stored at least once.

The tare weight zero-setting procedure is the following:

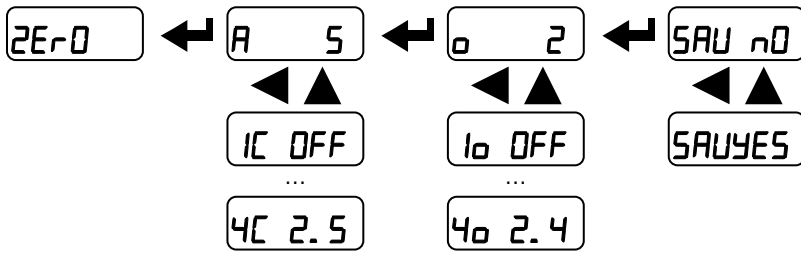

- Confirm the message **Zero** by pressing .
- The current weight value, preceded by the letter **A**, is displayed.
- Press and to display in sequence the current load distribution on each channel (**IC ÷ 4C**); press to return to the previous display.
- By pressing the last weight set to zero, preceded by the letter **0**, is displayed.
- Press and to display in sequence the load distribution stored during the last zero-setting on each channel (**I0 ÷ 40**); press to return to the previous display.
- Press and select **SAUYES** or **SAU n0** to store or not the current distribution and the zero mV values (see section **TEST**).
- By pressing the weight value to be set to zero is displayed, in this phase all of the LEDs are flashing.
- Confirming once again, the weight is set to zero (the value is stored to the permanent memory).
- Press to display the value of the total weight reset by the instrument, given by the sum of all of the previous zero settings.

ZERO VALUE MANUAL ENTRY



WARNING: Perform this procedure only if it's not possible to reset the weighed structure tare, for example because it contains product that cannot be unloaded.
Set in this parameter the estimated zero value (from -99999 to +999999; default: 0).

REAL CALIBRATION (WITH SAMPLE WEIGHTS)

000000 ← + ✕ CALIB ← FS-LED ← ▲ UEI GHE

After having performed the THEORETICAL CALIBRATION, EQUALIZATION and TARE WEIGHT ZERO SETTING, this function allows correct calibration to be done using sample weights of known value and, if necessary, any deviations of the indicated value from the correct value to be corrected.

Load onto the weighing system a sample weight, which must be **at least 50%** of the maximum quantity to be weighed.

By confirming the message **UEI GHE** the flashing value of the weight currently on the system is displayed. In this phase all of the LEDs are off. Adjust the value on display by using the arrow keys if necessary. After confirming, the new set weight will appear with all the LEDs flashing. After an additional confirmation, the message **UEI GHE** will be restored and by repeatedly pressing the key **✕** the weight will once again be displayed.

Example: for a system of maximum capacity 1000 kg and 1 kg division, two sample weights are available, one of 500 kg and the other one of 300 kg. Load both weights onto the system and correct the indicated weight to 800. Now remove the 300 kg weight, the system must show 500; remove the 500 kg weight too; the system must read zero. If this does not happen, it means that there is a mechanical problem affecting the system linearity.

WARNING: identify and correct any mechanical problems before repeating the procedure.



- If theoretical full scale and recalculated full scale in real calibration are equal, it means that the theoretical calibration is currently in use; otherwise, the real calibration based on sample weights is in use.
- If the correction made changes the previous full scale for more than 20%, all the parameters with settable weight values are reset to default values.

LINEARISATION OPTION ON MAX 8 POINTS:

It is possible to perform a linearisation of the weight repeating the above-described procedure up to a maximum of eight points, using eight different sample weights. The procedure ends by pressing the **✕** button or after entering the eighth value; at this point it will no longer be possible to change the calibration value, but only to perform a new real calibration. To perform a new calibration, should return to the weight display and then re-entering into the calibration menu.

By pressing **▲** after having confirmed the sample weight that has been set, the full scale appears, recalculated according to the value of the maximum sample weight entered and making reference to the cell sensitivity set in the theoretical calibration (**SEnSi b**).

STABILITY

000000  +  CALI b  FS-tEO ◀ ▲ STAbLE

TYPE: select how the weight is considered stable:





- **NOdEO:** the weight value must remain within the same division for a time greater than or equal to that specified in parameter **tI PE**;
- **NOdE I:** the variation of the weight value must be less than or equal to a division for a time greater than or equal to that specified in parameter **tI PE**.









tI PE (from 0.1 to 3.0 ms; default: 1.0 s): time needed to consider the weight stable.

CONFIRMATION AND CHANGE OF ACTIVE CHANNELS

After performing the calibration and verifying that the system works properly, you can confirm the channels automatically detected by the instrument; in this way, in case of accidental interruption of the cable of one or more load cells, the instrument displays the **ErCEL I** alarm.

000000 ◀ + ✕ CALI b ◀ FS-tEO ◀ ▲ SEL CH

AUTO (default): confirmation is requested (**SUR-EP**), press  to proceed or press  to cancel. The display shows the number of channels automatically detected by the instrument, press  to confirm and save the current selection or press  to exit with no change.

MANUAL confirmation is requested (**SUR-EP**), press  to proceed or press  to cancel. Press  or  to select the channel, confirm with  and press  or  to activate (**On**) or deactivate it (**OFF**); press  to save the current selection and exit.



After editing, you must repeat equalization, zero setting and calibration using a sample weight.

EQUALIZATION



At the end of the equalization you must perform the **TARE WEIGHT ZERO SETTING** and, if necessary, the **REAL CALIBRATION**.

REAL EQUALIZATION

000000 ← + × CALIB ← FS-LED ← ▲ E9AL ← E9rEA



Use a sample weight equal to **at least 50%** of the single load cell capacity.

E9AL0: unload the scale, wait for stability and confirm by pressing

E9AL1: place the sample weight on load cell 1, wait for stability and confirm by pressing

E9AL2: place the sample weight on load cell 2, wait for stability and confirm by pressing

Repeat the operation for each connected load cell.

If equalization is successfully completed, the display shows **ALID**, confirm by pressing to exit; if an error occurs, the display shows **FAIL**, confirm by pressing and repeat the procedure.

THEORETICAL EQUALIZATION

000000 ← + × CALIB ← FS-LED ← ▲ E9AL ← E9LED

SEN5 1 ÷ SEN5 4: set the sensitivity for each load cell, leaving it at 0 for non-active channels.

EQUALIZATION COEFFICIENTS

000000 ← + × CALIB ← FS-LED ← ▲ E9AL ← E9EH

E9H 1 ÷ E9H 4: it displays the equalization coefficients calculated for each active channel.

EQUALIZATION DELETION

000000 ← + × CALIB ← FS-LED ← ▲ E9AL ← DELE9U

Confirmation is requested (**SURE?**), press to reset the equalization or press to cancel the command.

FILTER ON THE WEIGHT

000000 ← + × CALIB ← ▲ FILTER

Setting this parameter allows a stable weight display to be obtained.

Two filter types are available:

- *TYPE 0*: Laumas standard filter (default);
- *TYPE 1*: moving average filter with fixed refresh frequency.

To increase the effect (weight more stable) increase the filter level (from 0 to 9, default 4).

Procedure:

- By confirming the *FILTER* message, the currently programmed filter type is displayed.
- Select the desired filter type and confirm, the currently programmed filter level is displayed.
- Select the desired filter level and confirm, the weight is displayed and it will be possible to experimentally verify its stability.
- If stability is not satisfactory, repeat the procedure until an optimum result is achieved.

The filter enables to stabilise a weight as long as its variations are smaller than the corresponding "response time". It is necessary to set this filter according to the type of application and to the full scale value set.

LEVEL	Response time* [ms]		Display and serial port refresh frequency* [Hz]	
	<i>TYPE 0</i>	<i>TYPE 1</i>	<i>TYPE 0</i>	<i>TYPE 1</i>
0	12	100	300	100
1	150	330	100	100
2	260	500	50	100
3	425	700	25	100
4	850	1100	12.5	100
5	1700	1600	12.5	100
6	2500	2700	12.5	100
7	4000	3500	10	100
8	6000	5000	10	100
9	7000	6800	5	100
A	6	—	600	—

*indicative values

The "A" filter can only be set if the instrument is connected to one load cell only.

ANTI PEAK

When the weight is stable, the anti peak filter removes any sudden disturbances with a maximum duration of 1 second. Confirm the filter on the weight with  and select one of the following options:

- *AntPOn*: anti peak filter enabled (default);
- *AntPOF*: anti peak filter disabled.

ZERO PARAMETERS

  +     

RESETTABLE WEIGHT SETTING FOR SMALL WEIGHT CHANGES

SEt (from 0 to full scale; default: 300; considered decimals: 300 – 30.0 – 3.00 – 0.300): this parameter indicates the maximum weight value resettable by external contact, keypad or serial protocol.

AUTOMATIC ZERO SETTING AT POWER-ON

Auto 0 (from 0 to 10% of full scale; default: 0): if at switch-on the weight value is lower than the value set in this parameter, the weight is reset. To disable this function, set 0.

ZERO TRACKING

TRAC 0 (from 1 to 5, default: *nOnE*): when the weight value is stable and, after a second, it deviates from zero by a figure in divisions smaller or equal to the figure in divisions set in this parameter, the weight is set to zero. To disable this function, set *nOnE*.

Example: if the parameter *dI U! 5* is set to 5 and *TRAC 0* is set to 2, the weight will be automatically set to zero for variations smaller than or equal to 10 (*dI U! 5* x *TRAC 0*).

SETTING UNITS OF MEASURE

000000 ← + × CALI b ← FS-tEO ← ▲ unit

These are the available units of measure:

HI LOG: kilograms

G: grams

t: tons

Lb: pounds*

nEUton: newtons*

LI t r E: litres*

bAr: bars*

Atm: atmospheres*

PI ECE: pieces*

nEU-Π: newton metres*

HI LO-Π: kilogram metres*

DEHER: other generic units of measure not included in the list*

If the print function is enabled, the symbol corresponding to the selected unit of measure will be printed after the measured value.



For the units marked with * it's possible to set also the display coefficient (parameter **COEFF**, see the related section). To use the display coefficient is necessary to enable it via fieldbus or by closing the **COEFF** input (see sections **OUTPUTS AND INPUTS CONFIGURATION (BASE program)** and **OUTPUTS AND INPUTS CONFIGURATION (LOAD program)**).

DISPLAY COEFFICIENT (BASE program)

000000 ← + × CALI b ← FS-tEO ← ▲ COEFF

By setting the coefficient **COEFF** the display is changed accordingly.

If one of the inputs is set to **COEFF** mode (see section **OUTPUTS AND INPUTS CONFIGURATION**) when the input is closed the value will be displayed modified according to the **COEFF** coefficient; when the input is opened the standard weight display will be restored. The display coefficient can also be enabled via fieldbus.

COEFF: (max settable value: 99.9999; default: 1.0000) will have different meanings according to the value set in **unit**, i.e. the selected unit of measure. (see section **SETTING UNITS OF MEASURE**).

If the unit of measure chosen is:

Lb: pounds, the value set in **CDEFF** will be multiplied by the weight value currently displayed;

nEUton: newton, the value set in **CDEFF** will be multiplied by the weight value currently displayed;

LITRE: litres, in **CDEFF** set the specific weight in kg/l, assuming that the system is calibrated in kg;

BAR: bar, the value set in **CDEFF** will be multiplied by the weight value currently displayed;

ATM: atmosphere, the value set in **CDEFF** will be multiplied by the weight value currently displayed;

PIECE: pieces, in **CDEFF** set the weight of one piece;

nEU-N: newton metres, the value set in **CDEFF** will be multiplied by the weight value currently displayed;

HILO-N: kilogram metres, the value set in **CDEFF** will be multiplied by the weight value currently displayed;

OTHER: generic unit of measure not included in the list, the value set in **CDEFF** will be multiplied by the weight value currently displayed.



WARNING: All other settings (setpoint, hysteresis, calibration ...) are expressed in weight value. If you want to convert them to the new unit of measurement, perform one of the following procedures for changing the system calibration.

The parameter **CDEFF** must remain set to 1.0000.

THEORETICAL CALIBRATION'S CHANGE FOR OTHER UNITS OF MEASURE

Set in the parameter **F5-EE** the F.SCALE value divided by the conversion coefficient from kg to the new unit of measure.

Example: the 4 load cells of 1000 kg are placed under a scale for olive oil, which has a specific gravity of 0.916 kg/l. Setting the F.SCALE = $(4 \times 1000) / 0.916 = 4367$, the system works in liters of olive oil.

Also, if you set the parameter **UNIT = LITRE** (see section **SETTING UNITS OF MEASURE**), the system will display and print the symbol "l" instead of "kg".

REAL CALIBRATION'S CHANGE FOR OTHER UNITS OF MEASURE

Load a known quantity of product litres on the scale (equal to at least 50% of the maximum amount that you must weigh) and enter in the parameter **UEI GHT**, the product loaded value in litres. Also, if you set the parameter **UNIT = LITRE** (see section **SETTING UNITS OF MEASURE**), the system will display and print the symbol "l" instead of "kg".

OUTPUTS AND INPUTS CONFIGURATION (BASE program)

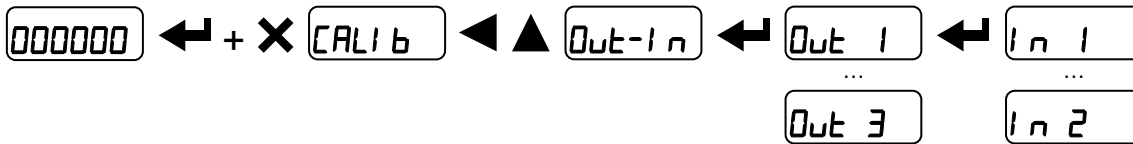

OUTPUTS

The outputs are set by default as follows: *OPE_n / SEt / GrOSS / POS_nEG / OFF*.

Possible operation modes:

- **OPE_n (normally open)**: the relay is de-energised and the contact is open when the weight is lower than the programmed setpoint value; it closes when the weight is higher than or equal to the programmed setpoint value.
- **CLDSE (normally closed)**: the relay is energised and the contact is closed when the weight is lower than the programmed setpoint value; it opens when the weight is higher than or equal to the programmed setpoint value.
- **SEt**: the contact will switch on the basis of weight, according to setpoint (see section **SETPOINT PROGRAMMING (BASE program)**).
- **PLC**: the contact will not switch on the basis of weight, but is controlled by remote protocol commands.
- **StAbLE**: relay switching occurs when the weight is stable.
- **ALArN**: relay switching occurs when one of the following alarms is triggered: *ErCEL*, *ErCELR*, *ErCEL I*, *Er DL*, *Er Ad*, "-----", *Er DF*; the operation mode is forced to **CLDSE** (normally closed).
- **CHDL**: relay switching occurs when one of the following conditions occurs:
 - the gross weight value on the single channel is higher than the value of parameter *CHSEt*;
 - the gross weight value detected by the system is higher than the value specified in the setpoints.

If the operation mode **SEt** is selected, the following options are also active:

- **GrOSS**: the contact will switch on the basis of gross weight.
- **nEt**: the contact will switch on the basis of net weight (If the net function is not active, the contact will switch on the basis of gross weight).
- **POS_nEG**: relay switching occurs for both positive and negative weight values.
- **POS**: relay switching occurs for positive weight values only.
- **nEG**: relay switching occurs for negative weight values only.

By confirming with  the setpoint operation can be set to the value 0:

- **OFF**: relay switching will not occur if the setpoint value is 0.
- **On**:
 - setpoint = 0 and switching = **POSnEG**: relay switching occurs when the weight is 0; the relay will switch again when the weight is different from zero, taking hysteresis into account (both for positive and for negative weights).
 - setpoint = 0 and switching = **POS**: relay switching occurs for a weight higher than or equal to 0, the relay will switch again for values below 0, taking hysteresis into account.
 - setpoint = 0 and switching = **nEG**: relay switching occurs for a weight lower than or equal to 0, the relay will switch again for values above 0, taking hysteresis into account.

INPUTS

Default: input 1 = **ZER0** input 2 = **nE-L0**

Possible operation modes:

- **nE-L0** (NET/GROSS): by closing this input for no more than one second, it's making an operation of SEMI-AUTOMATIC TARE and the display will show the net weight. To display the gross weight again, hold the NET/GROSS input closed for 3 seconds.
- **ZER0**: by closing the input for no more than one second, the weight is set to zero (see section **WEIGHT ZERO-SETTING FOR SMALL VARIATIONS (SEMI-AUTOMATIC ZERO)**).
- **PEEH**: keeping the input closed the maximum weight value reached remains on display. Opening the input the current weight is displayed.
- **PLC**: closing the input no operation is performed, the input status may however be read remotely by way of the communication protocol.
- **[On] n**: closing the input for max one second the weight is transmitted over the serial connection according to the fast continuous transmission protocol only once (**only if [On] n is set in the item SEr1 AL**).
- **[COEFF]**: when the input is closed the weight is displayed based on the set coefficient (see setting of the units of measure and coefficient), otherwise the weight is displayed.
- **Pr1 nEr**: when the input is closed the data are sent for printing if in the communication protocol of either serial port the parameter **Pr1 nEr** is set.

OUTPUTS AND INPUTS CONFIGURATION (LOAD program)

OUTPUTS

- OUTPUT 1: PRESET (for operation see **OPERATION SETTINGS**)
- OUTPUT 2: SET (for operation see **OPERATION SETTINGS**)
- OUTPUT 3: CYCLE END (the relay is closed to the achievement of Cycle End)



INPUTS

- INPUT 1: START
- INPUT 2: STOP

SEMI-AUTOMATIC TARE (NET/GROSS)



THE SEMI-AUTOMATIC TARE OPERATION IS LOST UPON INSTRUMENT POWER-OFF.

To perform a net operation (SEMI-AUTOMATIC TARE), close the NET/GROSS input or press the  key for less than 3 seconds. The instrument displays the net weight (just set to zero) and the NET LED lights up. To display the gross weight again, keep the NET/GROSS input closed or press  for 3 seconds. This operation can be repeated many times by the operator to allow the loading of several products.

Example:

Put the box on the scale, the display shows the box weight; press , the display shows the net weight to zero; introduce the product in the box, the display shows the product weight. This operation can be repeated several times.



While the net weight is displayed, keep  pressed to display gross weight. When the key is released the net weight will be displayed again.

The semi-automatic tare operation is not allowed if the gross weight is zero (the display shows *1 n2Er0*).

PRESET TARE (SUBTRACTIVE TARE DEVICE)

000000 ◀ + ◀ P-TARE



It is possible to manually set a preset tare value to be subtracted from the display value provided that the $P-TARE \leq \text{max capacity}$ condition is verified.

By default the instrument shows the last programmed preset tare value: to apply it press ▲ and then ◀.

After setting the tare value, going back to the weight display, the display shows the net weight (subtracting the preset tare value) and the NET LED lights up to show that a tare has been entered. To delete a preset tare and return to gross weight display, hold down ◀ for about 3 seconds or keep the NET/GROSS input (if any) closed for the same length of time (3 seconds). The preset tare value is set to zero. The NET LED is turned off when the gross weight is displayed once again.



While the net weight is displayed, keep ▲ pressed to display the gross weight. When the key is released the net weight will be displayed again.



- IF A SEMI-AUTOMATIC TARE (NET) IS ENTERED, IT IS NOT POSSIBLE TO ACCESS THE ENTER PRESET TARE FUNCTION.
- IF A PRESET TARE IS ENTERED, IT'S STILL POSSIBLE TO ACCESS THE SEMI-AUTOMATIC TARE (NET) FUNCTION. THE TWO DIFFERENT TYPES OF TARE ARE ADDED.



ALL THE SEMI-AUTOMATIC TARE (NET) AND PRESET TARE FUNCTIONS WILL BE LOST WHEN THE INSTRUMENT IS TURNED OFF.

SEMI-AUTOMATIC ZERO (WEIGHT ZERO-SETTING FOR SMALL VARIATIONS)

By closing the SEMI-AUTOMATIC ZERO input, the weight is set to zero; alternatively, by pressing the ✕ key for less than 3 seconds, the SET message is displayed for 3 seconds, by pressing ◀ the weight is set to zero.

This function is only allowed if the weight is lower than the $\square SET$ value (see section **RESETTABLE WEIGHT SETTING FOR SMALL WEIGHT CHANGES**), otherwise the alarm E----- appears and the weight is not set to zero.



The zero-setting is lost upon instrument power-off.

PEAK (BASE program)

By keeping the PEAK input closed or by activating the function via fieldbus, the maximum weight value reached remains displayed. By opening the input or by deactivating the function via fieldbus, the current weight is displayed.



If you wish to use this input to view a sudden variation peak, set the FILTER ON THE WEIGHT to 0.

ANALOG OUTPUT (TLB4 ONLY)



- **TYPE**: it selects the analog output type (4÷20 mA, 0÷20 mA, 0÷10 V, 0÷5 V, ±10 V, ±5 V; default: 4÷20 mA).



For the output ±10 V and ±5 V a soldered jumper must be closed:

- open the instrument;
- locate in the printed circuit board the soldered jumper highlighted in the picture below:

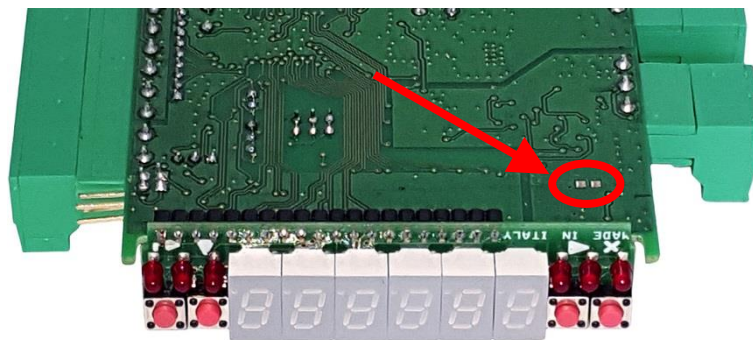

- close the jumper shorting the pads with a drop of tin.
- **MODE**: choice of a weight followed by the analog output: gross (**GROSS**) or net (**NET**). If the net function is not active, the analog output varies according to gross weight.
- **ANAL 0**: set the weight value for which you wish to obtain the minimum analog output value.



Only set a value different from zero if you wish to limit the analog output range; for instance: for a full scale value of 10000 kg you require an 4 mA signal at 5000 kg and 20 mA at 10000 kg, in this case, instead of zero, set 5000 kg.

- **ANAL FS**: set the weight value for which you wish to obtain the maximum analog output value; it must correspond to the value set in the PLC program (default: calibration full scale). E.g.: if I am using a 4÷20 mA output and in the PLC program I wish to have 20 mA = 8000 kg, I will set the parameter to 8000.

- **CO- 0**: analog output correction to zero: if necessary adjust the analog output, allowing the PLC to indicate 0. The sign “-“ can be set for the last digit on the left. E.g.: if I use a 4÷20 mA output and, with the minimum analog setting, the PLC or tester read 4.1 mA, I must set the parameter to 3.9 to obtain 4.0 on the PLC or tester.
- **CO- F5**: correction of analog output to full scale: if necessary permit modification of the analog output by allowing PLC to indicate the value set in the parameter **ANA F5**. E.g. if I am using a 4÷20 mA output with the analog set to full scale and the PLC or tester reads 19.9 mA, I must set the parameter to 20.1 to get 20.0 on the PLC or tester.

Minimum and maximum values which can be set for zero and full scale corrections:

ANALOG OUTPUT TYPE	Minimum	Maximum
0÷10 V	-0.150	10.200
0÷5 V	-0.150	5.500
±10 V	-10.300	10.200
±5 V	-5.500	5.500
0÷20 mA	-0.200	22.000
4÷20 mA	-0.200	22.000

NOTE: the analog output may also be used in the opposite manner, i.e. the weight setting that corresponds to the analog zero (**ANA 0**) may be greater than the weight set for the analog full scale (**ANA F5**). The analog output will increase towards full scale as the weight decreases; the analog output will decrease as the weight increases.

For example:

ANA 0 = 10000 ANA F5 = 0 analog output 0÷10 V

Weight = 0 kg analog output = 10 V

Weight = 5000 kg analog output = 5 V

Weight = 10000 kg analog output = 0 V



All analog outputs of the instrument are ACTIVE and SINGLE ENDED type, therefore they can be connected only to PASSIVE receiver devices. The minimum load allowed for voltage outputs is 10 kohm, the maximum load allowed for current outputs is 300 ohm.

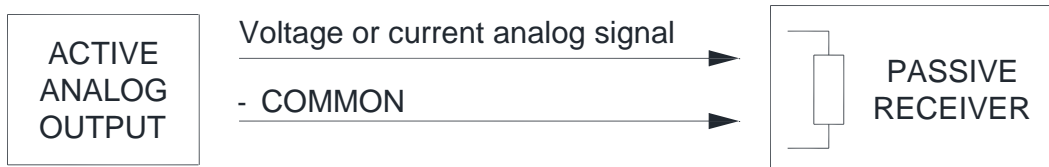

SERIAL COMMUNICATION SETTING

000000 ← + × CALIB ← ▲ SERIAL ← ↵ 5485

- *nOnE*: it disables any type of communication (default).
- *ModBUS*: MODBUS-RTU protocol; possible addresses: from 1 to 99 (see Communication protocols manual).
- *ASCII*: ASCII bidirectional protocol; possible addresses: from 1 to 99 (see Communication protocols manual).
 - *ModU60*
 - *Mod t d*
- *Cont n*: continuous weight transmission protocol (see Communication protocols manual), at the frequency set in *HEr t 2* item (from 10 to 300).
 - *Mod t* (set: *PARI t Y* = *nOnE*, *StOP* = 1).
 - *Mod t d* (set: *PARI t Y* = *nOnE*, *StOP* = 1).
- *rI P*: continuous weight transmission protocol to RIP5/20/60, RIP50SHA, RIPLD series remote displays; the remote display shows the net weight or gross weight according to its settings (set: *bAUd* = 9600, *PARI t Y* = *nOnE*, *StOP* = 1).
- *Hdri P*: continuous weight transmission protocol to RIP6100, RIP675, RIP6125C series remote displays; the remote display shows the net weight or gross weight according to its settings (set: *bAUd* = 9600, *PARI t Y* = *nOnE*, *StOP* = 1).
- *Hdri Pn*: continuous weight transmission protocol to RIP6100, RIP675, RIP6125C series remote displays (set: *bAUd* = 9600, *PARI t Y* = *nOnE*, *StOP* = 1).
 When the remote display is set to gross weight:
 - if the instrument displays the gross weight, the remote display shows the gross weight.
 - if the instrument shows the net weight, the remote display shows the net weight alternated with the message *nEt*.
- *PrI n t r*: printer.
- *I n CL*: communication protocol with inclinometer (see Inclinometer manual).
 - *bAUd*: transmission speed (2400, 4800, 9600, 19200, 38400, 115200; default: 9600).
 - *Addr*: instrument address (from 1 to 99; default: 1).

- **HErEz**: maximum transmission frequency (10 – 20 – 30 – 40 – 50 – 60 – 70 – 80 – 100 – 200 – 300; default: 10); to be set when the **Cont n** transmission protocol is selected.
Maximum setting frequency (**HErEz**):
 - 20 Hz with minimum baud rate 2400 baud.
 - 40 Hz with minimum baud rate 4800 baud.
 - 80 Hz with minimum baud rate 9600 baud.
 - 100 Hz with minimum baud rate 19200 baud.
 - 200 Hz with minimum baud rate 38400 baud.
 - 300 Hz with minimum baud rate 38400 baud.
- **dELAY**: delay in milliseconds which elapses before the instrument replies (from 0 to 200 ms; default: 0).
- **PARiTY**:
 - **nOnE**: no parity (default).
 - **EVEN**: even parity.
 - **Odd**: odd parity.
- **STOP**: stop bit (1 – 2; default: 1).
- **St bI t**: stability character (**YES** – **nO**; default: **nO**); to be set when the **Cont n** transmission protocol is selected in **Mod t** mode (see section **CONTINUOUS FAST WEIGHT TRANSMISSION PROTOCOL** in Communication protocols manual).
- **nCOPY**: number of copies(1 – 9; default: 1).
- **ENPEY**: number of blank lines between one printout and the next.
- **HEAdEr**: printing of custom heading from PC (**YES** – **nO**; default: **nO**).
- **PrEPOd**: connected printer type:
 - **P 190**
 - **STAU P**
 - **STAU t**



For more information about protocols and methods of communication, request the proper manual to technical assistance.

RS485 SERIAL COMMUNICATION

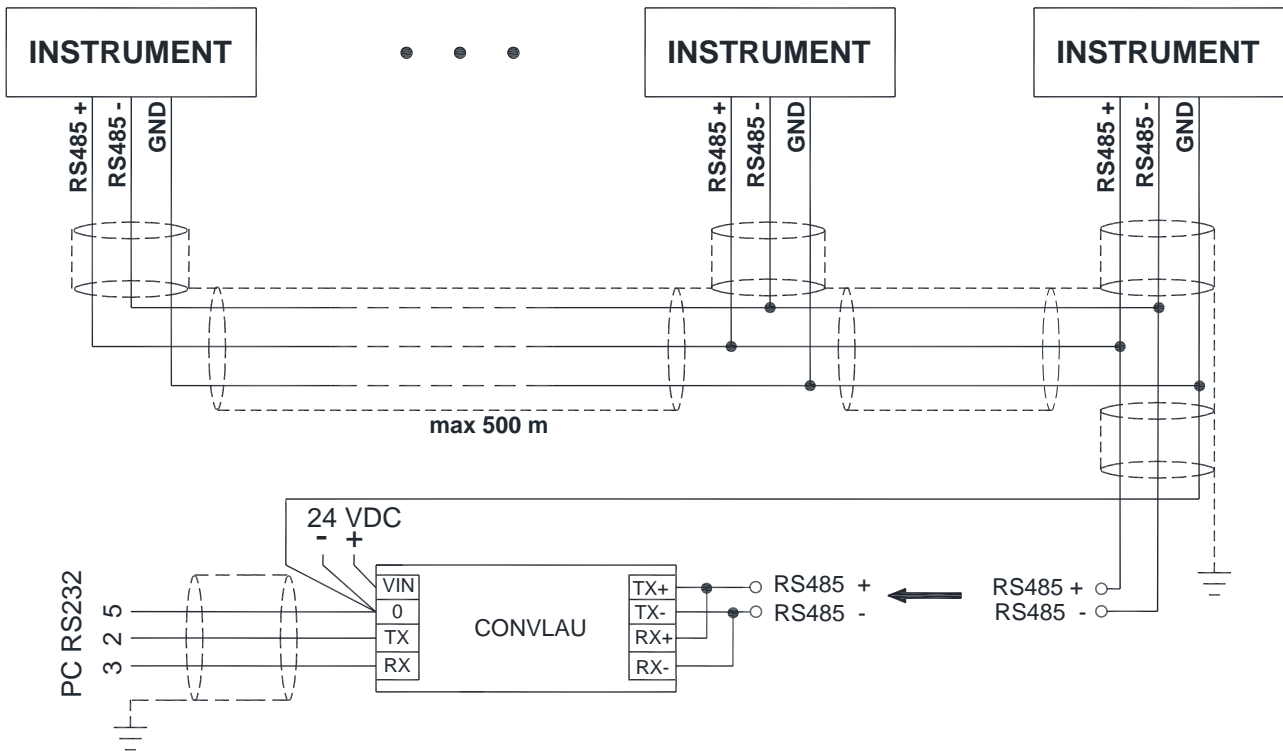

If the RS485 network exceeds 100 metres in length or baud-rate over 9600 are used, two terminating resistors are needed at the ends of the network: close the two jumpers indicated in the picture on the furthest instruments. Should there be different instruments or converters, refer to the specific manuals to determine whether it is necessary to connect the above-mentioned resistors.



DIRECT CONNECTION BETWEEN RS485 AND RS232 WITHOUT CONVERTER

Since a two-wire RS485 output may be used directly on the RS-232 input of a PC or remote display or printer, it is possible to implement instrument connection to an RS-232 port in the following manner:

INSTRUMENT		RS232
RS485 -	→	RXD
RS485 +	→	GND



This type of connection allows A SINGLE instrument to be used in a ONE WAY mode.

AUTOMATIC DIAGNOSTICS OF LOAD DISTRIBUTION



Only use this function in systems where load distribution can be repeated with each change of weight (for example: liquid weighing).

- **AUT** (YES/NO; default: NO): it enables load diagnostics.
- **STATUS**: it displays the active channels status (weight, load percentage on each channel, enabled channels and/or channels in error).
- **PREP**: it displays stored load distributions (weight, load percentage on each channel).
- **DELETE**: it deletes stored load distributions; confirmation is requested (**SURE?**), press to proceed or press to cancel.
- **ERR** (default: 5.0): difference between the current and stored percentage beyond which the **Err dI AG** alarm is triggered.
- **AUT 0** (YES/NO; default: NO): it enables diagnostics on zero.
- **ERR0** (default: 5.0): difference between the current and stored percentage beyond which the **Err dI AG** alarm is triggered.
- **COMP 0**: it displays current load distribution on zero and the one previously stored (weigh, load percentage on each channel).

Load diagnostics: the instrument, with stable weight, calculates and stores the load percentage on each channel. If under normal operation the load percentage error is higher than the value set in parameter **ERR**, the display shows the **Err dI AG** alarm alternated with the weight; the alarm remains active also upon instrument power-off, press to cancel.

Diagnostics on zero: when a zero-setting is performed from the **CALIB** menu, the instrument calculates the load percentage on each channel; diagnostics on zero is performed only if the load distribution has been stored at least once (see section **TARE WEIGHT ZERO SETTING**).

If with unloaded system the load percentage error is higher than the value set in parameter **ERR0**, the display shows the **Err dI AG** alarm alternated with the weight; the alarm remains active also upon instrument power-off, press to cancel.

TEST

000000 ← + × CALIB ← ▲ TEST

- **Load distribution:**

STATUS: it displays the active channels status (weight, load percentage on each channel, enabled channels and/or channels in error).

- **Input Test:**

I n: ensure that for each open input *0* is displayed, *1* is displayed when the input is closed.

- **Output Test:**

OUT: setting *0* ensure that the corresponding output opens. Setting *1* ensure that the corresponding output closes.

- **Analog Output Option Test (TLB4 only):**

ANALOG: It allows the analog signal to range between the minimum and the maximum values starting from the minimum.

PA: current output test.

VOLT: voltage output test.

- **Millivolt Test:**

UV-CEL: it displays the response signal of each load cell expressed in mV with three decimals.

- **Millivolt stored at zero setting (only if *AUT 0 = YES*):**

UV-0-0: it displays the response signal of each load cell, expressed in mV with three decimals (see section **TARE WEIGHT ZERO SETTING**)

EVENTS LOG

000000 ← + × [CALI b] ◀ ▲ [EUEnt]

The instrument can store up to 50 events; the oldest records are overwritten.

- **dI S EU**: it displays the last 50 events stored, starting from the most recent one:
 - zERD**: zero-setting from the calibration menu, press ◀ to display the value set to zero.
 - FtED**: theoretical calibration, press ◀ to display the full scale set.
 - FrER**: real calibration, press ◀ to display the sample weight used.
 - I nPD**: tare setting via the keypad, press ◀ to display the set value.
 - dI AG**: load distribution error, press ◀ to display the weight value that triggered the alarm, press ◀ again to display the difference between the load percentage and the stored value.
 - ALL**: weight alarm, press ◀ to display the alarm type.
 - dELr**: load distribution deletion.
 - EQU**: equalization.
 - CHn**: modification or deletion of the manual selection of active channels.
- **dEL EU**: it deletes stored events; confirmation is requested (**SURER**), press ◀ to proceed or press × to cancel.
- **PrE EU**: it prints all events.





INFO MENU

000000 ← + × [CALI b] ◀ ▲ [i nFO]

- GENrI C**: the identification data of the instrument are displayed.
- **I nStRn**: instrument model
 - **SU COd**: software code
 - **PrOGn**: program type
 - **FU UEr**: software version
 - **SER nu**: serial number

SETPOINT PROGRAMMING (BASE program)

From the weight display, press  to access the setpoint setting.

- : to enter a menu/confirm the data entry.
- : to modify the displayed figure or menu item.
- : to select a new figure or modify the displayed menu item.
- : to cancel and return to the previous menu.

   ...    ...   

- *SEt* (from 0 to full scale; default: 0): Setpoint; relay switching occurs when the weight exceed the value set in this parameter. The type of switching is settable (see section **OUTPUTS AND INPUTS CONFIGURATION**).
- *HYSLE* (from 0 to full scale; default: 0): Hysteresis, value to be subtracted from the setpoint to obtain contact switching for decreasing weight. For example with a setpoint at 100 and hysteresis at 10, the switching occurs at 90 for decreasing weight.
- *CHSEt* (from 0 to full scale; default: 0): gross weight value for each channel, after which the contact switches, in case of associated function *CHOL* (see section **OUTPUTS AND INPUTS CONFIGURATION (BASE program)**).



These values are set to zero if the calibration is changed significantly (see sections **THEORETICAL CALIBRATION** and **REAL CALIBRATION (WITH SAMPLE WEIGHTS)**).

USE WITH W SERIES INSTRUMENTS (BASE program)



WARNING: the weight indicator must be properly configured before operating in combination with the multi-channel weight transmitter (see section **DATA DELETION AND PROGRAM SELECTION** in *W* serie instrument manual) and the approval status set on both instruments must be the same.

When the TLB4 is used in combination with a *W* serie instrument, the load cells are connected to the multi-channel weight transmitter, which transmits the weight to the indicator; all the operations of calibration, zeroing, equalization and channel selection can be performed remotely through the indicator.

CONNECTION TO THE WEIGHT INDICATOR

Connection via **RS485** port.

SIGNAL	TLB4	Weight indicator
RS485 +	29	RS485 +
RS485 -	30	RS485 -
SHIELD	9	SHIELD

Weight indicator configuration

Configure, on the serial port used, the *RTS/CTS* protocol with the following parameters:

bAUD = 9600 *PARITY* = NONE *STOP* = 1

TLB4 multi-channel weight transmitter configuration

Configure, on the serial port used, the MODBUS protocol with the following parameters:

bAUD = 9600 *PARITY* = NONE *STOP* = 1

ADDITIONAL MENU MAP



WARNING: the map shows only the additional menu items that are enabled on the W series instruments connected to the TLB4.

Into menus changes are applied right after pressing the **ENTER** key (no further confirmation is required).

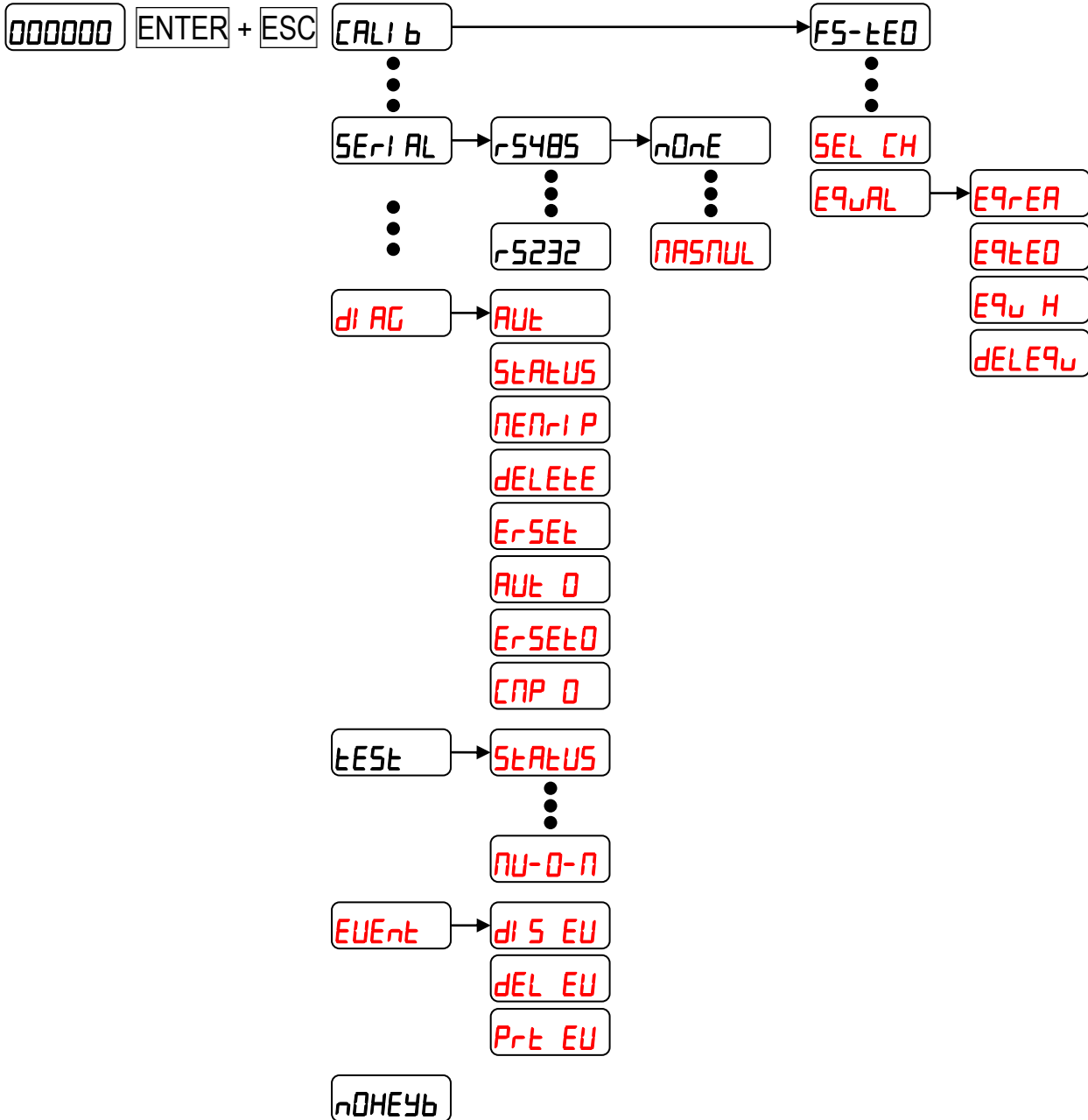

TLB4 REMOTE CONTROL

The following functions of TLB4 can be performed remotely through the weight indicator:

- INSTRUMENT COMMISSIONING
- TARE WEIGHT ZERO SETTING
- CONFIRMATION AND CHANGE OF ACTIVE CHANNELS
- EQUALIZATION
- FILTER ON THE WEIGHT
- ANTI PEAK
- AUTOMATIC DIAGNOSTICS OF LOAD DISTRIBUTION
- LOAD DIAGNOSTICS
- DIAGNOSTICS ON ZERO
- TEST
- EVENTS LOG



WARNING: when using the weight indicator to manage the multi-channel instrument, the weight indicator display replicates exactly what would be displayed on the TLB4 display.

If the configuration is performed on the TLB4, the W series instrument connected must be restarted to allow synchronization.

REMOTE KEYPAD LOCKING

000000 ENTER + ESC CALI b ◀ ▲ nDHEyb

YES: keypad locked.

nD: keypad unlocked.

ADDITIONAL ALARMS



WARNING: the list shows only the additional alarms that are enabled on the W series instruments connected to the TLB4.



Er CON: TLB4 is not responding, check connections and serial ports settings.

Er rES: TLB4 responds incorrectly, check connections and serial ports settings.

Er UArE: issues with the serial communication device.

SynC: the instrument is synchronizing with TLB4, wait for the end of the operation.

ALARMS

- nOCEL:** no load cell detected, check the connections.
- ErCEL:** the load cell signal exceeds 39 mV; the conversion electronics (AD converter) is malfunctioning.
- ErCELLr:** the load cell excitation is not connected or is incorrectly connected; the references are not connected or are incorrectly connected; the load cell is a 4-wire and there are no jumpers between EX- and REF- and between EX+ and REF+.
- ErCEL I:** the load cell is not connected or is incorrectly connected (the number indicates the channel on which the error is detected).
- Er DL:** the weight display exceeds 110% of the full scale.
- Er Ad:** internal instrument converter failure; check load cell connections, if necessary contact technical assistance.
- :** the weight exceeds the maximum capacity by 9 divisions.
- Er DF:** maximum displayable value exceeded (value higher than 999999 or lower than -999999).
- E-----:** weight too high: zero setting not possible.
- PAH-PU:** this message appears in the sample weight setting, in real calibration, after the eighth sample weight value has been entered.
- Error:** the value set for the parameter is beyond the permitted values; press  to quit the setting mode leaving the previous value unchanged. Examples: a number of decimals is selected for full scale which exceeds the instrument's display potential; value above the maximum setting value; the weight value set in sample weight verification does not match the detected mV increase; the analog output correction goes beyond the permitted limits.
- bLOC:** lock active on menu item, keypad or display.
- nOdl SP:** It's not possible to display properly the number because is greater than 999999 or less than -999999.
- bUI CE:** the current load cell has already been equalized; press  to go back to the previous step and move the sample weight on the next load cell.
- LOAD:** the sample weight was not loaded or is too light.
- Er dl AG:** the load percentage error is higher than the value set in parameters **ErSEt** or **ErSEt0**; press  to cancel the alarm.
- l nZEr0:** gross weight equal to zero: the semi-automatic tare operation cannot be performed.
- bUS Er:** issues with the fieldbus device.

Serial protocol alarms:

	<i>Er CEL</i>	<i>Er OL</i>	<i>Er Ad</i>	<i>-----</i>	<i>Er OF</i>	<i>t-----</i>
MODE						
Bit LSB	76543210	76543210	76543210	76543210	76543210	The response to the zero command is a "value not valid" error (error code 3)
Status Register MODBUS RTU	xxxxxxx1	xxxx1xxx	xxxxxxx1x	xxxxx1xx	On gross: xxx1xxxx On net: xx1xxxxx	
ASCII	O-F	O-L	O-F	O-L	O-F	&aa#CR
RIP *	O-F	O-L	O-F	O-L	O-F	O-F
HDRIP-N	ERCEL	ER OL	ER AD	#####	ER OF	O SET
CONTIN	ERCEL	ER OL	ER AD	^^^^^	ER OF	O SET

* For RIP remote displays, if the message exceeds 5 digits the display reads -----.

With an alarm the relays open and the analog outputs go to the lowest possible value according to the following table:

RANGE	0÷20 mA	4÷20 mA	0÷5 V	0÷10 V	±10 V	±5 V
Output value	-0.2 mA	3.5 mA	-0.5 V	-0.5 V	0 V	0 V

BATCHING (LOAD program)

INTRODUCTION TO THE OPERATION

The instrument is able to load automatically a settable amount of product on the weighing structure, driving the batching organ (including two-speed) through the PRESET and SET contacts.

The instrument has the following features:

- 1 settable formula (see section **FORMULA PROGRAMMING**);
- automatic fall calculation (see section **FALL**);
- autotare at batching start (see section **AUTOTARE**);
- tolerance error control (see section **TOLERANCE**);
- precision batching through slow function (see section **SLOW**);
- precision batching through tapping function (see section **TAPPING FUNCTION**);
- consumption storage (see section **CONSUMPTION**).

BATCHING START:

via external contact or remotely via fieldbus.

CONSUMPTION STORAGE:

the instrument, at the end of every batching, stores the consumed amount. Consumptions value can be viewed directly on instrument display or via the communication protocol when the instrument is in standby mode.

ALARM MANAGEMENT:

if an alarm occurs during the batching, the instrument shows the alarm on the display and waits for operator intervention to abort or continue the batching.

BATCHING SEQUENCE

The batching process consists of the following steps:

- batching sequence programming;
- batching start;
- batching execution;
- waiting phase;
- cycle end phase.

BATCHING SEQUENCE PROGRAMMING

In case of remote control of the instrument, select the number of cycles to run.

BATCHING START

Start the batching by closing the START external contact for at least 0.5 s.



If at the end of the batching the START contact is closed, the same batching sequence is repeated.

The instrument will ensure that:

- the formula has been programmed, otherwise it will display the alarm **EMPTY**;
- the amount set in the formula does not exceed the set maximum weight (**MASS**), otherwise the message **MASSDR** is displayed;
- the gross weight is lower than the minimum weight (**MIN**), otherwise the alarm **AREP** is displayed (however it is possible to force batching start by pressing .
- only if **EDUAL = YES**:
 - if the consumed amount exceeds 999000, the **EDUAL** message appears for a second;
 - if the consumed amount exceeds 999999, it is automatically set to zero.

Once these conditions have been verified, the instrument proceed to the batching execution phase.

BATCHING EXECUTION

The batching consists of an initial FAST phase and a subsequent SLOW phase.

During the entire batching execution, the instrument:

- monitors the weight of the product's batched quantity;
- commands the PRESET and SET contacts according to the **P55** parameter setting (see section **OPERATION SETTINGS**);
- if the **ENLOAD** time is set and the product is not loaded by at least 20 divisions within this interval of time, activates the **LOADP** alarm.

The FAST phase ends when one of the following conditions occurs:

- only if **SLOW** is set: the batched quantity has reached the set value minus the slow value;
- the batched quantity has reached the preset value set in formula.

During the SLOW phase:

- only if **ENCOMP** is set: the instrument does not verify the reaching of set value until the **NO COMPARISON TIME** has elapsed;
- if a tapping value has been set, the SET contact performs opening and closing cycles according to the times set by **SLOWON** and **SLOWOFF** parameters.

When the batched quantity reaches the set value configured in the formula minus any fall value, the SLOW phase ends and the SET contact opens, interrupting the product flow.

WAITING PHASE

After opening the SET, the instrument shows the weight preceded by the letter **A** and waits:

- only if $ELNE = YES$: the waiting time has elapsed ($ELNEAL$);
 - only if $CONAnd = YES$: the START input has been closed or the  key has been pressed or confirmed via fieldbus;
- only if $STABLE = YES$: the weight is stable.

If the tolerance (EDL) is set, three conditions can occur:

- the batched quantity is less than the set quantity minus the tolerance value; the SLOW phase is performed again to improve the batching accuracy. If the error condition persists, the EDL alarm is activated;
- the batched quantity is greater than the set quantity plus the tolerance value; the EDL alarm is enabled;
- the batched quantity falls within the tolerance limits.

To cancel the EDL alarm and proceed, press  or confirm via fieldbus.

When all the set conditions are met, the waiting phase ends and the batching cycle continues.

CYCLE END PHASE

The system enters the cycle end phase:

- the CYCLE END contact is closed;
- only if $EDLAL = YES$: consumption is stored;
- From the beginning of the product extraction, if the $enUnLD$ time is set and the product is not extracted for at least 20 divisions within this interval of time, the $UnLORd$ alarm is activated.

The instrument ends the batching, and opens the CYCLE END contact, only after verifying that:

- the weight is lower than the minimum weight (Min);
- the safe emptying time has elapsed (ESL).

Only if $SLAVE = YES$: the instrument waits for remote data reading, before being available for a new batching.

If several batching cycles have been set, the instrument starts a new cycle.

OPERATION SETTINGS



nEHt P: select the switch conditions from the SET opening to the CYCLE END closing.

- **tI NE** (default: **YES**): time set in constants (**tI NEAt**);
- **CONAnd** (default: **n0**): START input closure or key pressure;
- **StABLE** (default: **n0**): stable weight.

P55 (default: **2**): select the operating mode of SET and PRESET contacts.

- **P55 = 1**: at the batching start, only the PRESET contact is closed; once reached the preset set value, the related contact is opened and the SET contact is closed; reached the final value of set, the related contact is opened;
- **P55 = 2**: at the batching start, the SET and PRESET contacts are closed simultaneously; once reached the preset value, the related contact is opened (beginning of the slow phase); once reached the set value, also the related contact is opened. For single-speed batching, program **P55 = 2** and use only the SET contact;
- **P55 = 3**: at the batching start, only the PRESET contact is closed; once reached the preset value, also the SET contact is closed; once reached the final value of set, both are reopened.

EndnEt (default: **n0**): select the display type of net / gross weight during the CYCLE END phase (unloading of the scale at the end of batching).

- **YES**: during the cycle end, the net weight is displayed. After the CYCLE END opening, the gross weight is displayed;
- **n0**: during the cycle end, the gross weight is displayed.

DISPLAYING DURING BATCHING

During the batching the display shows the weight preceded by the letter **b**.

By pressing the formula number is displayed, by pressing it again the number of running cycle is displayed.

BATCHING STOP

Open the START contact and close the STOP contact to stop the batching. If the START contact is closed, the **StAr-t?** alarm is displayed.

Alternatively, stop the batching via fieldbus.

CONSUMPTION

If in constants consumption is enabled ($\text{tOt} = \text{YES}$), the quantities batched are stored.



Selecting tOtAL the total quantity consumed (divided by 100) is displayed. The quantities will be printed out in full.

CONSUMPTION DELETION



To delete consumption confirm CAncEL , the SUR-E deletion confirmation is requested; confirm again with \leftarrow or press \times to cancel the command.

If the printer is enabled (see section **SERIAL COMMUNICATION SETTING**) an operation receipt is printed.

PROGRAMMING OF BATCHING CONSTANTS

From weight display press \leftarrow , then press \blacktriangle several times until COnt is displayed and confirm.

- \leftarrow : to enter a menu/confirm the data entry.
- \blacktriangle : to modify the displayed figure or menu item.
- \blacktriangleleft : to select a new figure or modify the displayed menu item.
- \times : to cancel and return to the previous menu.

MINIMUM WEIGHT

Min (from 0 to full scale; default: 10): minimum weight, value at which the scale is considered empty. Batching start is only allowed if the weight is lower than this value, during the unloading phase the CYCLE END contact will be opened when the weight reaches this value and after the safe emptying time is over.

MAXIMUM WEIGHT

MASS (from 0 to full scale; default: 0): settable and displayable maximum weight. If the displayed weight exceeds the maximum weight by 9 divisions, the "-----" message is displayed; if in the formula programming the weight value set is greater than this value, the Error message is displayed and the value will not be stored.

By setting 0, the function is disabled.

SAFE EMPTYING TIME

ENI (from 0.0 to 999.9 seconds; default 5.0): time that is necessary for a perfect emptying of the scale. The instrument waits for this time during the unloading phase (CYCLE END closed), after reaching the minimum weight and before opening the CYCLE END contact to obtain a perfect emptying of the scale.

WAITING TIME

ENPERE (from 0.0 to 999.9 seconds; default 5.0): time elapsing between the SET end batching and the CYCLE END closing to allow the weight to get steady. This waiting time is only required if the automatic fall is programmed and/or consumption is enabled and/or printing is enabled and/or a tolerance value has been programmed and/or confirmation from PC is enabled.

NO COMPARISON TIME

ENCOMP (from 0.0 to 999.9 seconds; default: 0.0): this is the instrument waiting time during batching, after the opening of PRESET, before comparing the weight with the programmed SET value.

NO PRODUCT LOAD TIME

ENLOAD (from 0.0 to 999.9 seconds; default: 0.0): this parameter allows the product control during batching. if there is no product load, the instrument waits for a set duration of time before activating the alarm **LOAD**.

NO PRODUCT UNLOAD TIME

ENUNLO (from 0.0 to 999.9 seconds; default: 0.0): this parameter allows the product control during the unloading phase (cycle end). If there is no product extraction, the instrument waits for a set duration of time before activating the alarm **UNLOAD**.

WARNING: The control is only actuated after unloading of the product has started (the weight must decrease by at least 10 divisions).

FALL

By FALL it means the correction of the product amount in fall after the batching STOP. This amount is in addition to the product already batched causing inaccuracy. The instrument is able to anticipate the batching STOP, to reduce this uncertainty, with two possible ways:

- AUTOMATIC fall: the instrument automatically calculates the fall;
- MANUAL fall: the instrument applies the fall set by the operator;

WARNING: Setting a value of **WAITING TIME (ΕΙ ΠΕΡΕ)** such that the weight is stable at the end of the batching, otherwise the update of the AUTOMATIC fall is not correct.

ΠΟΔFAL

ΠΟΔFAL (from 1 to 99; default: 0): it's possible to select the automatic or the manual fall.

- *ΠΟΔFAL* = 0: MANUAL fall;
- *ΠΟΔFAL* different from 0: AUTOMATIC fall (the set value shows how many batchings the fall value is updated).

Note: In the batching cycles in which the fall value is not updated, the **WAITING TIME** is not applied, unless there are no other functions that require the **WAITING TIME** (eg prints...). So, by setting a high value, it reduces the duration of batchings.

Example: If *ΠΟΔFAL* = 3 the AUTOMATIC fall is calculated every three batching cycles.

FALdl μ (only if ΠΟΔFAL ≠ 0)

FALdl μ (from 0 to full scale; default: 0): this parameter indicates the limit within which the automatic fall is updated according to the parameter *ΠΟΔFAL*. By setting a low value is obtained more accurately but the length of the batchings could increase, because, if necessary, the AUTOMATIC fall is updated every cycle regardless of *ΠΟΔFAL*. By setting 0, the function is disabled.

Example: by setting *ΠΟΔFAL* = 3, *FALdl μ* = 5 and the weight equal to 100, the instrument updates the fall every batching, until the batched weight falls within the 95 to 105 range, and then it goes back to update the AUTOMATIC fall every 3 batchings.

FALL

FALL (from 0 to maximum weight; default: 0): in this parameter it is possible to set the fall value (only if *ΠΟΔFAL* = 0) or to display and/or to modify the fall value calculated automatically by the instrument (only if *ΠΟΔFAL* ≠ 0).

TOLERANCE

LDL (from 0 to maximum weight; default: 0): parameter that defines how much the batched weight value can deviate from the one set in formula. If the batched weight is higher or lower than the amount to be batched, for a value greater than the tolerance, the instrument shows the **LDL** alarm. Press  or confirm via fieldbus to continue the batching.

By setting 0, the function is disabled.

Example: if a SET = 1000 value is set and a TOLERANCE = 100 value is set, the batched weight must not be lower than 900 or higher than 1100 to allow the instrument to continue the batching process.

SLOW

SLOW (from 0 to maximum weight; default: 0): replaces the preset value. When the weight has reached the SET value minus the value set in this parameter, the slow batching phase starts by the PRESET contact. If the set value is greater than the weight to batch, the batching will be in slow phase. By setting 0, the function is disabled.

Example: if SET = 100 and SLOW = 15, the slow phase begins when the weight reaches 85.

TAPPING FUNCTION

In the event that the batching instrument is not equipped with the speed “slow” it is possible to use this function to slow down the product batching in the final phase (through opening and closing cycles of the SET contact) and to increase the accuracy. Set in **SLOW** parameter the product amount you want to batch with the tapping function enabled.

SLOW ON

SLOWON (from 0 to 9.9; default: 0): time in which the SET relay remains closed during the SLOW phase. By setting 0, the function is disabled.

SLOW OFF

SLOWOFF (from 0 to 9.9; default: 0): time in which the SET relay remains open during the SLOW phase. By setting 0, the function is disabled.

AUTOTARE

AUTARE (from 0 to 999; default: 0): autotare enabling (automatic tare at batching start); the autotare will be updated every as many cycles of a single batching sequence as are set in this parameter. By setting 0, the function is disabled.

This operation is possible only if the gross weight is lower than the minimum weight (**MIN**), otherwise the **ALARM** alarm message is displayed.

AUTOTARE DELAY

ELPETA (only if **AREARE** \neq 0, from 0 to 99.9; default: 0): the instrument waits for this time, after the starting of the formula, before performing the autotare and starting the batching.

STABLE TARE

STABETA (only if **AREARE** \neq 0, default: **NO**): autotare enabled at stable weight.

- **YES**: if autotare enabled, zero-setting at batching start is done after a possible delay time and only when the weight is stable.
- **NO**: if autotare enabled, zero-setting is done right after the delay time.

CONSUMPTION

ETOTAL (default **NO**): enabling consumption memory (total batched quantity).

- **YES**: consumption enabled
- **NO**: consumption disabled.

PRINT AT CYCLE END

PRINT (default **NO**): function enabling to print batching data at cycle end.

- **YES**: print enabled
- **NO**: print disabled

NUMBER OF BATCHING PRINTOUTS

NCOPY (from 1 to 9; default: 1): number of copies of the batching printout.

WAITING CONFIRMATION FROM PC (SLAVE)

SLAVE (default: **NO**): waiting for confirmation of record batching data from PC.

- **YES**: check enabled; the instrument waits for the PC to read the batching data, before starting another batching. In case of recording failure, the instrument displays an alarm **SLAVE**.
- **NO**: check disabled; at cycle end, the instrument will not wait for data recording on PC before performing another batching.

FORMULA PROGRAMMING

Confirm with  the *FD-P* prompt and set *PrESEt* and *SEt* of the batching formula.





PrESEt is NOT displayed if a *SLOW* value has been set in the constants (*SLDU*).

In case of attempt in *PrESEt* or *SEt* to set a value higher than the maximum weight (*MASS*) set in the batching constants, the message *ErrOr* is displayed.

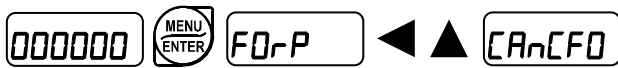
DELETING FORMULA



Confirm with  the *CARCFD* prompt, to delete the formula you will be prompted to confirm (*SURE*), to delete confirm again with  otherwise press  to cancel the command.

ADDITIONAL ALARMS RELATING TO BATCHING

- EARLY:** it is displayed if, at batching start, the weight on the scale is higher than the minimum set in constants (π n). Press **X** to return to the weight displaying, press **←** to cancel the alarm and continue with the batching. If the weight comes back below to the minimum set, the batching starts.
- EDL:** it is displayed if at batching end the weight is different from the value set in formula by a value higher than tolerance. Press **←** or confirm via fieldbus to cancel the alarm and continue with the batching.
- FALL:** it is displayed if at batching start the fall value is higher than the product quantity to be batched. Press **X** to cancel the alarm and the batching.
- EMPTY:** it is displayed if, at batching start, the formula recalled for running is not programmed. Press the key **X** to quit.
- MAXFO:** it is displayed if, at batching start, the formula recalled for running exceeds the maximum weight. Press the key **X** to quit.
- LOAD:** during the batching it indicates that the product is not loaded. It is automatically cancelled if the product increases. Otherwise stop the batching (see section **BATCHING STOP**).
- UNLOAD:** during the unload (Cycle End contact closed) it indicates that the product is not extracted. It is automatically cancelled if the product decreases. Otherwise stop the batching (see section **BATCHING STOP**).
- STARTP:** it is displayed for 3 seconds if you try to stop the batching (by closing the STOP input) when the START input is closed. Open the START input to cancel the alarm.
- PARSER:** batching is cancelled. Press **X** to quit. If the alarm persists, contact technical assistance.
- ERRUEI G:** it is displayed when there is a weight alarm and it cancels the current batching. Press **X** to go back to the weight display and check the alarm.
- ERROR:** the value set for the parameter is beyond the permitted values; press **X** to quit the setting mode leaving the previous value unchanged. Examples: a number of decimals is selected for full scale which exceeds the instrument's display potential; value above the maximum setting value; the weight value set in sample weight verification does not match the detected mV increase; the analog output correction goes beyond the permitted limits.
- COND:** waiting for START closure or **←** key pressure to continue the batching.
- SLAVE:** PC has not read batching data.

PRINTING EXAMPLES

If the printer has been set (see section **SERIAL COMMUNICATION SETTINGS**), from the weight display press the  key:

BASIC PRINTOUT

```
-----  
TLB4   BASE   Addr:01  
  
GROSS           878 kg  
NET             589 kg  
TARE           289 kg
```

BASIC PRINTOUT (PEAK ENABLED):

```
-----  
TLB4   BASE   Addr:01  
  
GROSS           1204 kg  
NET             831 kg  
TARE           373 kg  
PEAK           2103 kg
```

PRINTOUT WITH **COEFF** ENABLED:

```
-----  
TLB4   BASE   Addr:01  
  
UNIT    kg |      bar  
G       1195 |     1792  
N       1195 |     1792  
T         0 |         0
```

LOAD DISTRIBUTION PRINT

Current distribution: press the  key from the *STATUS* menu.

Current and stored distribution: from the *COMP* and *MEMRIP* menus, keep pressed the  key for more than 3 seconds while the weight is displayed.

CURRENT DISTRIBUTION

```
-----  
TLB4  BASE      Addr:01  
CURRENT (STATUS)  
GROSS      2014 kg  
CH1:       23.5 %  
CH2:       24.1 %  
CH3:              ERR      (load cell connected but in error)  
CH4:              OFF      (load cell not connected)
```

CURRENT AND STORED DISTRIBUTION

```
-----  
TLB4  BASE      Addr:01  
STORED (MEMRIP)  
GROSS      2014 kg  
CH1:       23.5 %  
CH2:       24.1 %  
CH3:              ERR      (load cell connected but in error)  
CH4:              OFF      (load cell not connected)  
GROSS  OLD      2050 kg  
CH1:       25.5 %  
CH2:       22.1 %  
CH3:              ERR      (load cell connected but in error)  
CH4:              OFF      (load cell not connected)
```

BATCHING PRINTOUT

Batching without tare ($ALRE = 0$)

TLB4 LOAD Addr:01
FORMULA: 01
CYCLE: 1/ 1

INIT.WEIGHT 10 kg
GROSS 1005: 1000 kg

Batching with tare each cycle ($ALRE = 1$)

TLB4 LOAD Addr:01
FORMULA: 01
CYCLE: 1/ 1

TARE 34 kg
NET 1005: 1000 kg

Batching with reset every X cycles ($ALRE = X$)

TLB4 LOAD Addr:01
FORMULA: 01
CYCLE: 2/ 2

INIT.WEIGHT 1 kg
GROSS 1070: 1000 kg

TLB4 LOAD Addr:01
FORMULA: 01
CYCLE: 1/ 2

ZERO WEIGHT 12 kg
GROSS 1026: 1000 kg

CONSTANTS PRINTOUT

```
-----  
TLB4   LOAD      Addr:01  
        CONSTANTS  
MIN                      10  
MASS                      0  
TIME SIC                  5.0  
TIME WAIT                 5.0  
TIME NCOMP                0.0  
TIME NLOAD                0.0  
TIME NUNLOAD              0.0  
FALL                      MANUAL  
SLOW                      0  
TIME SLOWON               0.0  
TIME SLOWOF               0.0  
PSS                       2  
AUTOTARE                  NO  
UNLOAD                    GROSS  
TOTAL                     NO  
PRINT                     NO  
SLAVE                     NO  
BLACKOUT                  MANUAL  
  
FOR.      FALL      TOLER  
01        0         100
```

FORMULA PRINTOUT

Standard formula printout (*SLOU* = 0)

```
-----  
TLB4   LOAD      Addr:01  
FORMULA:                01  
PSET                      2500 kg  
SET                       3000 kg
```

Formula with slow active printout (*SLOU* = 200)

```
-----  
TLB4   LOAD      Addr:01  
FORMULA:                01  
SLOW                      200 kg  
SET                       3000 kg
```

CONSUMPTION PRINTOUT

```
-----  
TLB4   LOAD      Addr:01  
        CONSUMPTION  
TOTAL                      2604 kg
```

If consumption is set to zero, it will also be printed:
CONSUMPTION ERASED

FRONT PANEL MOUNTING

TLB4 (except PROFIBUS DP version) can be installed on front panel using the included mounting kit:

- drilling size: 23x96 mm
- maximum panel thickness: 2.5 mm

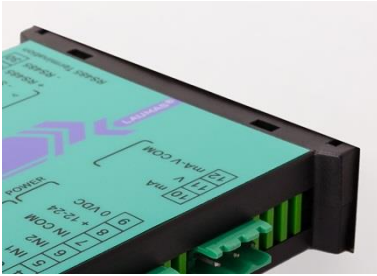

Pull out the terminal strips and insert the instrument into the hole.



Insert the mounting brackets into the housings, on both sides of the instrument.

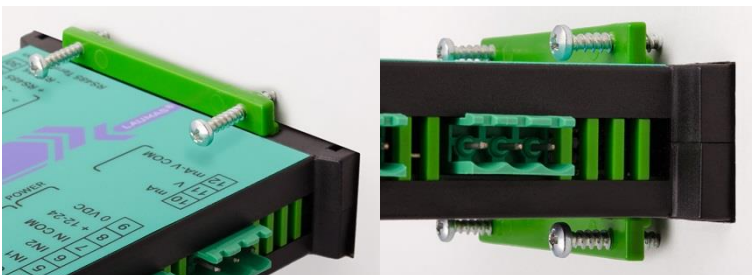







Tighten the four screws up to lock the instrument.







RESERVED FOR THE INSTALLER

MENU LOCKING





Through this procedure, it's possible to block the access to any menu on the instrument. Select the menu that you wish to lock:

   press  and  simultaneously for 3 seconds, the display shows  (the left point on the text indicates that this menu item is now locked). If the operator tries to enter this menu, the access is denied and the display shows .

MENU UNLOCKING



   press  and  simultaneously for 3 seconds, the display shows  (the left point on the text is off to indicate that this menu item is unlocked).

TEMPORARY MENU UNLOCKING

   press  and  simultaneously for 3 seconds: it is now possible to enter and modify all menus including those which are locked. By returning to weight display, the menu lock is restored.

DATA DELETION AND PROGRAM SELECTION



WARNING: operations must only be performed after contacting technical assistance. After each operation the display shows *dOnE*, press  to continue. By pressing  the procedure is cancelled and no changes are made.

Upon instrument power-on hold down the  key until the display shows *PrOG*, then proceed as follows:

CONSTANTS RESTORE (does not erase the calibration): confirm *PrOG*, use arrow keys to select *PrSSU*, set code 6935 and confirm.

PROGRAM SELECTION: confirm *PrOG* and use the arrow keys to select the desired program:

bASE: basic program, setpoint management only.

r iP: weight remote display program with setpoint.

LOAD: single product loading program.

After confirming the choice of the program (except *r iP*), the user must choose its approval status among the following possible choices:



nOLEG: not approved program;

LEGAL: approved program, single interval (Dir. 2014/31/EU, art. 1)*;

LEGN: approved program, multi-interval (Dir. 2014/31/EU, art. 1)*;

- *) Contact technical assistance to request the proper manual and the correct procedures for approval, indicating mandatory hardware code and serial number (see section **INSTRUMENT COMMISSIONING**).



When the TLB4 is used in combination with a W serie instrument, the approval status set on both devices must be the same.

By confirming, the instrument is restored to default and data is erased.



If you do not have a specific manual for the newly set program, you can request it to technical assistance.

KEYPAD OR DISPLAY LOCKING

Press immediately followed by and hold them down for about 5 seconds (this operation is also possible via the MODBUS and ASCII protocols):

- *FrEE*: no lock.
- *HEy*: keypad lock: if active, when a key is pressed the message *bLOC* is displayed for 3 seconds.
- *di SP*: keypad and display lock: if active, the keypad is locked and the display shows the instrument model (weight is not displayed); by pressing a key the display shows *bLOC* for 3 seconds.

DECLARATION OF CONFORMITY - EU

LAUMAS

Innovation in Weighing

SISTEMI DI PESATURA INDUSTRIALE - CELLE DI CARICO - BILANCE

LAUMAS Elettronica S.r.l.
Via I Maggio 6 - 43022 Montechiarugolo (PR) Italy
C.F. - P.IVA IT01661140341

Tel. (+39) 0521 683124
Fax (+39) 0521 681091

Email: laumas@laumas.it
Web: <http://www.laumas.com>

Fabbricante metrico Prot. N. 7340 Parma - R.E.A. PR N. 169833 - Reg. Imprese PR N.19393 - Registro Nazionale Pile N. IT09060P00000982 - Registro A.E.E. N. IT0802000002494 - N. Mecc. PR 008385 - Cap. Sociale € 100.000 int. vers.

SISTEMA QUALITÀ CERTIFICATO UNI EN ISO 9001 - SISTEMA GESTIONE AMBIENTALE ISO 14001 - MODULO D: GARANZIA DELLA QUALITÀ DEL PROCESSO DI PRODUZIONE

I	Dichiarazione di conformità	Dichiariamo che il prodotto al quale la presente dichiarazione si riferisce è conforme alle norme di seguito citate.
GB	Declaration of conformity	We hereby declare that the product to which this declaration refers conforms with the following standards.
E	Declaración de conformidad	Manifestamos en la presente que el producto al que se refiere esta declaración está de acuerdo con las siguientes normas
D	Konformitäts-erklärung	Wir erklären hiermit, dass das Produkt, auf das sich diese Erklärung bezieht, mit den nachstehenden Normen übereinstimmt.
F	Déclaration de conformité	Nous déclarons avec cela responsabilité que le produit, auquel se rapporte la présente déclaration, est conforme aux normes citées ci-après.
CZ	Prohlášení o shode	Tímto prohlašujeme, že výrobek, kterého se toto prohlášení týká, je v souladu s níže uvedenými normami.
NL	Conformiteit-verklaring	Wij verklaren hiermede dat het product, waarop deze verklaring betrekking heeft, met de hierna vermelde normen overeenstemt.
P	Declaração de conformidade	Declaramos por meio da presente que o produto no qual se refere esta declaração, corresponde às normas seguintes.
PL	Deklaracja zgodności	Niniejszym oświadczamy, że produkt, którego niniejsze oświadczenie dotyczy, jest zgodny z poniższymi normami.
RUS	Заявление о соответствии	Мы заявляем, что продукт, к которому относится данная декларация, соответствует перечисленным ниже нормам.

Models: TLB4, TLB4+/-10, TLB4+/-5, TLB4+05, TLB4+010, TLB4+020, TLB4+420, TLB4RS485, TLB4CANOPEN, TLB4CCLINK, TLB4DEVICENET, TLB4ETHERCAT, TLB4ETHETCP, TLB4ETHEIP, TLB4MODBUSTCP, TLB4POWERLINK, TLB4PROFIBUS, TLB4PROFINETIO, TLB4SERCOS

Mark Applied	EU Directive	Standards
CE	2014/35/EU Low Voltage Directive	<i>Not Applicable (N/A)</i> for VDC type EN 61010-1:2010 for 230/115 VAC type
CE	2014/30/EU EMC Directive	EN 55011:2016+A1+A11:2020 EN 61000-6-2:2019 EN 61000-6-4:2019 EN 61000-4-2:2009 EN 61000-4-3:2006+A2:2010 EN 61000-4-4:2012 EN 61000-4-5:2014+A1:2017 EN 61000-4-6:2014
CEM (only if "M" mark is applied)	2014/31/EU NAWI Directive	EN 45501:2015 OIML R76-1:2006

Montechiarugolo (PR), 20/12/2021

LAUMAS Elettronica s.r.l.
M. Consonni
(Legal Representative)

M. Consonni

DECLARATION OF CONFORMITY - UKCA

LAUMAS

Innovation in Weighing

SISTEMI DI PESATURA INDUSTRIALE - CELLE DI CARICO - BILANCE

LAUMAS Elettronica S.r.l.
Via I Maggio 6 - 43022 Montechiarugolo (PR) Italy
C.F. - P.IVA IT01661140341

Tel. (+39) 0521 683124
Fax (+39) 0521 681091

Email: laumas@laumas.it
Web: <http://www.laumas.com>

Fabbricante metrico Prot. N. 7340 Parma - R.E.A. PR N. 169833 - Reg. Imprese PR N.19393 - Registro Nazionale Pile N. IT09060P00000982 - Registro A.E.E. N. IT0802000002494 - N. Mecc. PR 008385 - Cap. Sociale € 100.000 int. vers.

SISTEMA QUALITÀ CERTIFICATO UNI EN ISO 9001 - SISTEMA GESTIONE AMBIENTALE ISO 14001 - MODULO D: GARANZIA DELLA QUALITÀ DEL PROCESSO DI PRODUZIONE

I	Dichiarazione di conformità	Dichiariamo che il prodotto al quale la presente dichiarazione si riferisce è conforme alle norme di seguito citate.
GB	Declaration of conformity	We hereby declare that the product to which this declaration refers conforms with the following standards.
E	Declaración de conformidad	Manifestamos en la presente que el producto al que se refiere esta declaración está de acuerdo con las siguientes normas
D	Konformitäts-erklärung	Wir erklären hiermit, dass das Produkt, auf das sich diese Erklärung bezieht, mit den nachstehenden Normen übereinstimmt.
F	Déclaration de conformité	Nous déclarons avec cela responsabilité que le produit, auquel se rapporte la présente déclaration, est conforme aux normes citées ci-après.
CZ	Prohlášení o shode	Tímto prohlašujeme, že výrobek, kterého se toto prohlášení týká, je v souladu s níže uvedenými normami.
NL	Conformiteit-verklaring	Wij verklaren hiermede dat het product, waarop deze verklaring betrekking heeft, met de hierna vermelde normen overeenstemt.
P	Declaração de conformidade	Declaramos por meio da presente que o produto no qual se refere esta declaração, corresponde às normas seguintes.
PL	Deklaracja zgodności	Niniejszym oświadczamy, że produkt, którego niniejsze oświadczenie dotyczy, jest zgodny z poniższymi normami.
RUS	Заявление о соответствии	Мы заявляем, что продукт, к которому относится данная декларация, соответствует перечисленным ниже нормам.

Models: TLB4, TLB4+/-10, TLB4+/-5, TLB4+05, TLB4+010, TLB4+020, TLB4+420, TLB4RS485, TLB4CANOPEN, TLB4CCLINK, TLB4DEVICENET, TLB4ETHERCAT, TLB4ETHETCP, TLB4ETHEIP, TLB4MODBUSTCP, TLB4POWERLINK, TLB4PROFIBUS, TLB4PROFINETIO, TLB4SERCOS

Mark Applied	UK legislation	Standards
UK CA	Electrical Equipment (Safety) Regulations 2016	<i>Not Applicable (N/A)</i> for VDC type BS EN 61010-1:2010 for 230/115 VAC type
UK CA	Electromagnetic Compatibility Regulations 2016	BS EN 55011:2016+A1+A11:2020 BS EN 61000-6-2:2019 BS EN 61000-6-4:2019 BS EN 61000-4-2:2009 BS EN 61000-4-3:2006+A2:2010 BS EN 61000-4-4:2012 BS EN 61000-4-5:2014+A1:2017 BS EN 61000-4-6:2014

Montechiarugolo (PR), 20/12/2021

LAUMAS Elettronica s.r.l.
M. Consonni
(Legal Representative)

M. Consonni

Teléfonos / Phone number

Mex: +52 (33)-3854-5975

+52 (33)-3823-4349

USA: +1 (619) 619-7350

Página Web / Website

tienda.logicbus.com.mx

logicbus.com

Correo electrónico / E-mail

ventas@logicbus.com

sales@logicbus.com



Dirección / Address



Av. Fray Antonio Alcalde 1822

Miraflores, 44270

Guadalajara, Jal



8280 Clairemont Mesa Blvd

Suite 122

San Diego, CA 92111

