

CV-W124/P2202 Series

24" TFT Full HD 16:9 Display Modular / Expandable
Panel PC with 12th Gen. Intel® Core™ i5 / i3 Processor
& Resistive 5-wire / Projected Capacitive Touch



HIGH PERFORMANCE INDUSTRIAL PANEL PC | CV-100/P2000 Series |

Overview

The CV-100/P2202 series is a high-performance modular industrial panel PC with an Intel® Core™ U-series (Alder Lake-P) processor, a comprehensive selection of screen sizes, and flexible expansion. It includes a rich set of native I/O interfaces (1 GbE LAN, USB 3.2 Gen 2x1, COM, and DIO), has Mini PCIe, M.2 Key E Type 2230 expansion slots, and supports the exclusive CFM expansion module to add PoE and IGMP functions. Cincoze's exclusive CDS patented technology provides flexibility for future computer performance upgrades or display replacements. The rugged CV-100/P2202 series can meet the diverse applications of equipment machine HMI and production process visualization.

Key Features

- 24" TFT Full HD 16:9 LCD with Resistive 5-wire Touch / Projected Capacitive Touch / Glass Only
- Onboard Intel® Alder Lake-P U-Series Core™ Processor
- 2x DDR5 SO-DIMM Socket, Supports up to 4800MHz 64GB Memory
- Quad Independent Display (CDS / HDMI / DP / VGA)
- 1x M.2 Key E Type 2230 Socket for Intel CNVi / Wireless Module
- Designed with Aluminum Die-cast Front Bezel
- Front Panel IP65 Compliant

Certifications



Excellent Computing Performance

The CV-100/P2202 series is equipped with the 12th Gen Intel® Core™ i5/i3 U-series (Alder Lake-P) processor based on the Intel® 7 process. The U-series has a low power consumption of only 15W, boasts excellent performance with up to 10 cores (2P+8E), and includes the built-in Intel® Iris Xe graphics to easily handle image classification inference performance in AI deep learning.

i5 Processor



i3 Processor

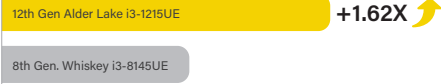

CDS Patented Technology

Cincoze Convertible Display System (CDS) patented technology makes field-side maintenance and future upgrades easier. Replacing a display or improving system performance only requires replacing a single component, which significantly cuts upgrade costs.

Patent No. M482908

Complete Range of Sizes

The CV-100/P2202 series has a diverse product portfolio, ranging from screen size (12 to 24 inches), display ratio (4:3, 5:4, and 16:9) to touch methods (multi-point P-Cap and single-point resistive), which can be selected based on application requirements.



Rugged, Safe, & More Reliable

To face harsh and rugged usage environments, the CV-100/P2202 series has a series of industrial-grade protections, including a wide operating temperature range (-20°C to 70°C), a wide range DC power input (9 to 48VDC), and a dustproof/water resistant IP65 front panel, which is beneficial for applications such as field-side HMI or production process visualization.



CV-W124 Series Specifications

Model Name	CV-W124R	CV-W124C	CV-W124G
Display			
LCD Size	• 24" (16:9)		
Max. Resolution	• 1920 x 1080		
Brightness (cd/m2)	• 300		
Contrast Ratio	• 5000 : 1		
LCD Color	• 16.7M		
Pixel Pitch (mm)	• 0.27675 (H) x 0.27675 (V)		
Viewing Angle (H-V)	• 178 / 178		
Backlight MTBF	• 50,000 hrs (LED Backlight)		
Touch Screen			
Touch Type	• Resistive 5-wire	• Projected Capacitive	• Glass Screen
Physical			
Dimension (W x D x H)	• 605 x 373 x 63.2 mm		
Weight Information	• 6.92 kg	• 6.64 kg	
Mechanical Construction	• Die-Casting Flat Surface		
Environment			
Front Panel Protection	• IP 65 Compliant		
Operating Temperature	• Ambient with Air flow: -20°C to 70°C (with Industrial Grade Peripherals)		
Storage Temperature	• -30°C to 80°C		
Relative Humidity	• 80% RH @ 50°C (Non-condensing)		
Vibration	• Operating, 1 Grms, 10-500 Hz, 3 Axes (w/P2012E only, according to IEC60068-2-6)		
EMC	• CE, UKCA, FCC, ICES-003 Class A		
EMI	<ul style="list-style-type: none"> • CISPR 32 Conducted & Radiated: Class A • EN/BS EN 55032 Conducted & Radiated: Class A • EN/BS EN IEC 61000-3-2 Harmonic current emissions: Class A • EN/BS EN61000-3-3 Voltage fluctuations & flicker • FCC 47 CFR Part 15B, ICES-003 Conducted & Radiated: Class A 		
EMS	<ul style="list-style-type: none"> • EN/IEC 61000-4-2 ESD: Contact: 4 kV; Air: 8 kV • EN/IEC 61000-4-3 RS: 80 MHz to 1000 MHz: 3 V/m • EN/IEC 61000-4-4 EFT: AC Power: 1 kV; DC Power: 0.5 kV; Signal: 0.5 kV • EN/IEC 61000-4-5 Surges: AC Power: 2 kV; Signal: 1 kV • EN/IEC 61000-4-6 CS: 3V • EN/IEC 61000-4-8 PFMF: 50 Hz, 1A/m • EN/IEC 61000-4-11 Voltage Dips & Voltage Interruptions: 0.5 cycles at 50 Hz 		
Safety	• UL, cUL, CB, IEC, EN 62368-1		

P2202 Specifications

Model Name	P2202	P2202E
System		
Processor	<ul style="list-style-type: none"> Onboard 12th Generation Intel® Alder Lake-P U-Series CPU: <ul style="list-style-type: none"> Intel® Core™ i5-1245UE 10 Cores Up to 4.40 GHz, TDP 15W Intel® Core™ i3-1215UE 6 Cores Up to 4.40 GHz, TDP 15W 	
Memory	<ul style="list-style-type: none"> 2x DDR5 4800MHz SO-DIMM Socket Supports Un-buffered and non-ECC Type, Up to 64GB 	
BIOS	<ul style="list-style-type: none"> AMI BIOS 	
Graphics		
Graphics Engine	<ul style="list-style-type: none"> Integrated Intel® Iris® Xe Graphics: Core™ i5-1245UE Integrated Intel® UHD Graphics: Core™ i3-1215UE 	
Maximum Display Output	<ul style="list-style-type: none"> Supports Quad Independent Display 	
CDS	<ul style="list-style-type: none"> 1x CDS Connector (1920 x 1080 @60Hz) 	
DP	<ul style="list-style-type: none"> 1x DisplayPort Connector (4096 x 2304 @60Hz) * Verified maximum resolution: 3840 x 2160 @ 60Hz 	
HDMI	<ul style="list-style-type: none"> 1x HDMI Connector (3840 x 2160 @30Hz) 	
VGA	<ul style="list-style-type: none"> 1x VGA Connector (1920 x 1200 @60Hz) 	
Audio		
Audio Codec	<ul style="list-style-type: none"> Realtek® ALC888, High Definition Audio 	
Line-out	<ul style="list-style-type: none"> 1x Line-out, Phone Jack 3.5mm 	
Mic-in	<ul style="list-style-type: none"> 1x Mic-in, Phone Jack 3.5mm 	
I/O		
LAN	<ul style="list-style-type: none"> 2x 1GbE LAN, RJ45 <ul style="list-style-type: none"> GbE1: Intel® I219 GbE2: Intel® I210 	
COM	<ul style="list-style-type: none"> 4x RS-232/422/485 with Auto Flow Control (Supports 5V/12V), DB9 	
USB	<ul style="list-style-type: none"> 3 x USB 3.2 Gen2x1 (10Gbps), Type A 1 x USB 2.0 (480Mbps), Type A 	
DIO	<ul style="list-style-type: none"> 16x Isolated Digital I/O (8in/8out), 20-Pin Terminal Block 	
Storage		
SSD/HDD	<ul style="list-style-type: none"> 2x 2.5" SATA HDD/SSD Bay (SATA3.0) 	
RAID	<ul style="list-style-type: none"> Support RAID 0/1 	
Expansion		
Mini PCI Express	<ul style="list-style-type: none"> 2x Full-size Mini-PCIe Socket 	
PCI Express	<ul style="list-style-type: none"> 1x PCI or 1x PCIe x4 Expansion slot (with Optional Riser Card) * Supports maximum dimensions of add-on card (H x L) : 111 x 169mm 	
SIM Socket	<ul style="list-style-type: none"> 1x SIM Socket 	
M.2	<ul style="list-style-type: none"> 1x M.2 Key E Type 2230 Socket, Support Intel CNVi/Wireless Module 	
CFM (Control Function Module) Interface	<ul style="list-style-type: none"> 1x CFM Interface for optional IGN Module Expansion 1x CFM Interface for optional PoE Module Expansion 	

CDS (Convertible Display System) Interface	• 1x CDS Interface for Convertible Display Module	
Other Function		
Clear CMOS Switch	• 1x Clear CMOS Switch	
Reset Button	• 1x Reset Button	
Instant Reboot	• Support 0.2sec Instant Reboot Technology	
Watchdog Timer	• Software Programmable Supports 256 Levels System Reset	
OSD Button	• LCD On/Off, Brightness Up, Brightness Down	
Internal Speaker	• AMP 2W + 2W	
Status LED Indicator	• Power LED, HDD LED	
Power		
Power Button	• 1x ATX Power On/Off Button	
Power Mode Switch	• 1x AT/ATX Mode Switch	
Power Input	• 9 - 48VDC, 3-pin Terminal Block	
Remote Power On/Off	• 1x Remote Power On/Off, 2-pin Terminal Block	
Operating System		
Windows	• Windows®11, Windows®10	
Linux	• Ubuntu 22.04	
Physical		
Dimension(W x D x H)	• 254.5 x 190 x 41.5 mm	• 254.5 x 190 x 61 mm
Weight Information	• 2.22 kg	• 2.74 kg
Mechanical Construction	• Extruded Aluminum with Heavy Duty Metal	
Mounting	• Wall / VESA / CDS / DIN Rail	
Physical Design	• Fanless Design • Jumper-less Design	
Reliability & Protection		
Reliability & Protection	• Yes	
Reverse Power Input Protection	• Protection Range: 51~58V • Protection Type: shut down operating voltage, re-power on at the preset level to recover	
Over Current Protection	• 15A	
CMOS Battery Backup	• SuperCap Integrated for CMOS Battery Maintenance-free Operation	
MTBF	• 216,747 Hours - Database: Telcordia SR-332 Issue3, Method 1, Case 3	
Environment		
Operating Temperature	• -40°C to 70°C * With extended temperature peripherals; Ambient with air flow * According to IEC60068-2-1, IEC60068-2-2, IEC60068-2-14	
Storage Temperature	• -40°C to 70°C	
Relative Humidity	• 95%RH @ 70°C (non-Condensing)	
Shock	• Operating, 50 Grms (w/ SSD, according to IEC60068-2-27)	
Vibration	• Operating, 1 Grms, 10-500 Hz, 3 Axes (w/ SSD, according to IEC60068-2-6)	

EMC	<ul style="list-style-type: none"> • CE, UKCA, FCC, ICES-003 Class A • EN IEC 61000-6-4, EN IEC 61000-6-2(24VDC Input Only)
EMI	<ul style="list-style-type: none"> • CISPR 32 Conducted & Radiated: Class A • EN/BS EN 55032 Conducted & Radiated: Class A • EN/BS EN IEC 61000-3-2 Harmonic current emissions: Class A • EN/BS EN61000-3-3 Voltage fluctuations & flicker • FCC 47 CFR Part 15B, ICES-003 Conducted & Radiated: Class A
EMS	<ul style="list-style-type: none"> • EN/IEC 61000-4-2 ESD: Contact: 4 kV; Air: 8 kV • EN/IEC 61000-4-3 RS: 80 MHz to 1000 MHz: 10 V/m • EN/IEC 61000-4-4 EFT: AC Power: 2 kV; DC Power: 1 kV; Signal: 1 kV • EN/IEC 61000-4-5 Surges: AC Power: 2 kV; Signal: 1 kV • EN/IEC 61000-4-6 CS: 10V • EN/IEC 61000-4-8 PFMF: 50 Hz, 30A/m • EN/IEC 61000-4-11 Voltage Dips & Voltage Interruptions: 1 cycles at 60 Hz
Safety	<ul style="list-style-type: none"> • UL, cUL, CB, IEC/EN 62368-1

CV-W124/P2202 External Layout

Front I/O

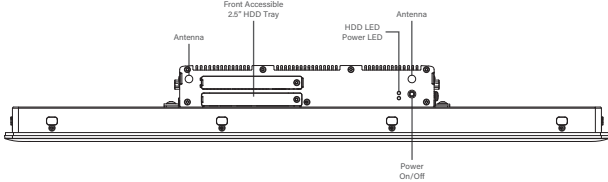

Rear I/O

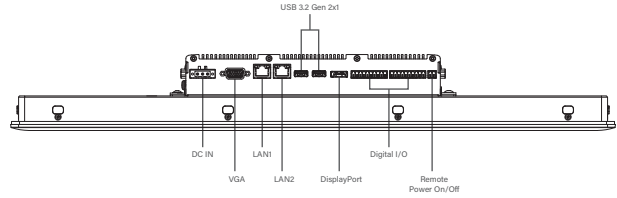

Left I/O

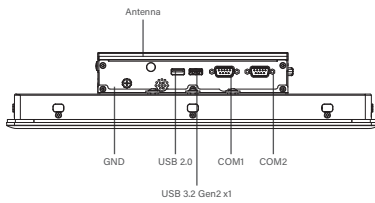

Right I/O

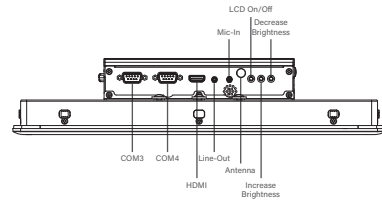

CV-W124/P2202E External Layout

Front I/O

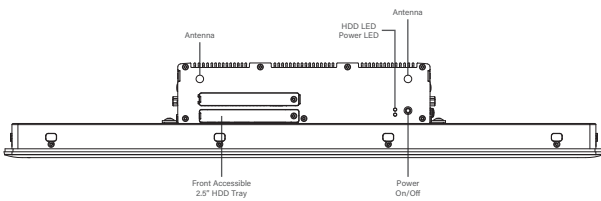

Rear I/O

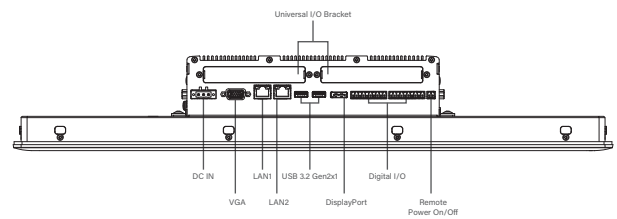

Left I/O

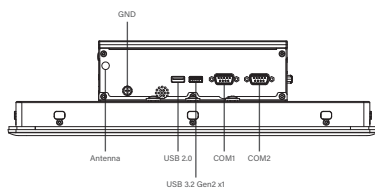

Right I/O

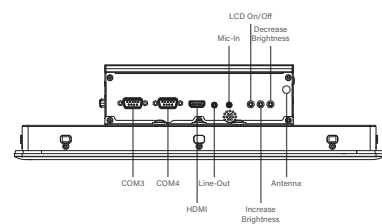

CV-W124/P2202 Dimensions

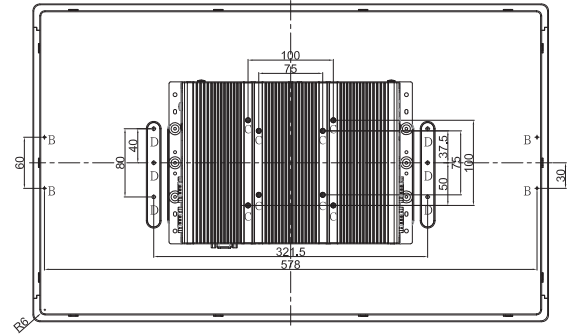
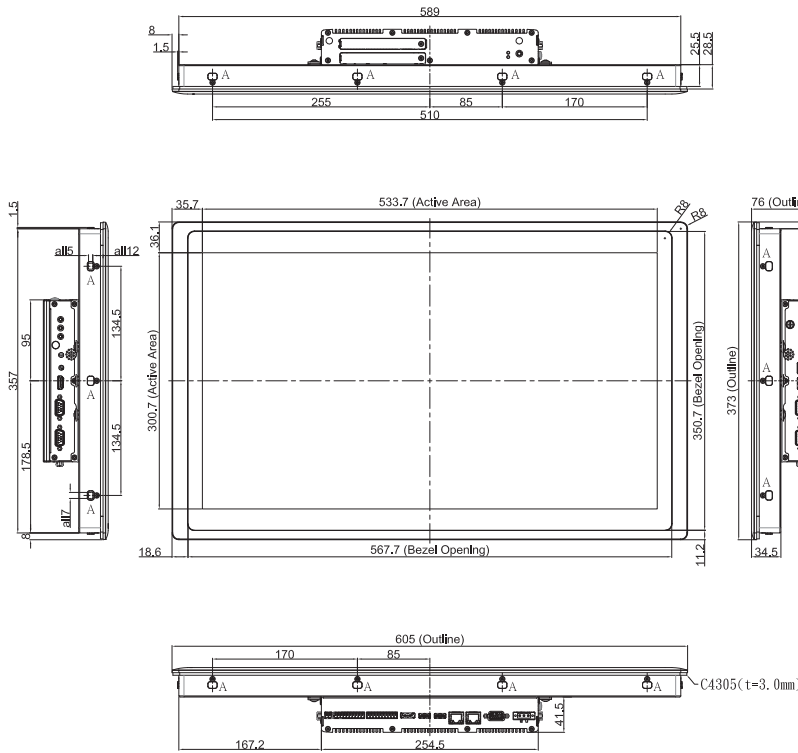

NOTE:

- 1.A=14_Panel Mount Hole
- 2.B=4_M3 Screw Holes(6 mm Length Limits)
- 3.C=8_M4 VESA Screw Holes(5 mm Length Limits)
- 4.D=6_M5 Screw Holes(5 mm Length Limits)

CV-W124/P2202E Dimensions

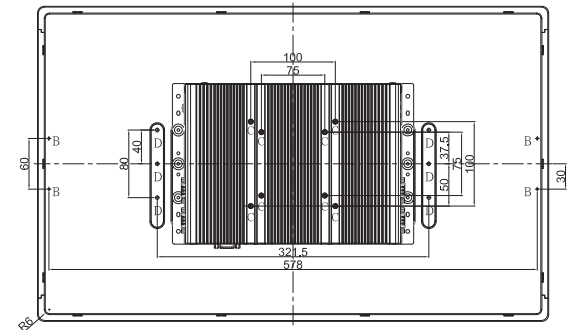
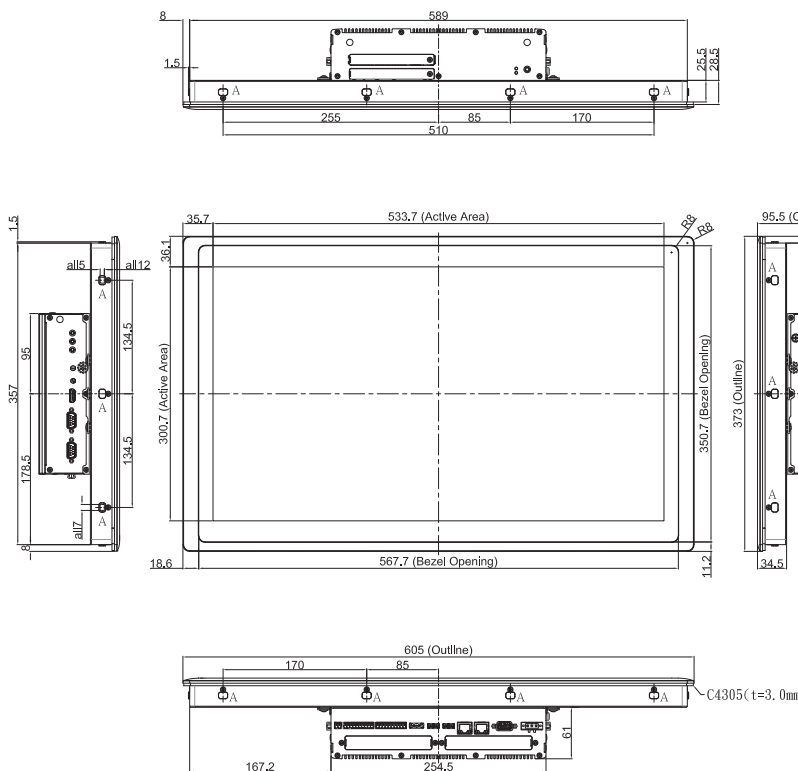

NOTE:

- 1.A=14_Panel Mount Hole
- 2.B=4_M3 Screw Holes(6 mm Length Limits)
- 3.C=8_M4 VESA Screw Holes(5 mm Length Limits)
- 4.D=6_M5 Screw Holes(5 mm Length Limits)

Ordering Information

Available Models

Model No.	Description
CV-W124R-R10/P2202-i5-R10	24" TFT Full HD 16:9 Display Modular Panel PC with 12th Gen. Intel® Core™ i5-1245UE Processor and Resistive 5-wire Touch
CV-W124R-R10/P2202E-i5-R10	24" TFT Full HD 16:9 Display Modular and Expandable Panel PC with 12th Gen. Intel® Core™ i5-1245UE Processor and Resistive 5-wire Touch
CV-W124C-R11/P2202-i5-R10	24" TFT Full HD 16:9 Display Modular Panel PC with 12th Gen. Intel® Core™ i5-1245UE Processor and Projected Capacitive Touch
CV-W124C-R11/P2202E-i5-R10	24" TFT Full HD 16:9 Display Modular and Expandable Panel PC with 12th Gen. Intel® Core™ i5-1245UE Processor and Projected Capacitive Touch
CV-W124G-R10/P2202-i5-R10	24" TFT Full HD 16:9 Display Modular Panel PC with 12th Gen. Intel® Core™ i5-1245UE Processor and without Touch
CV-W124G-R10/P2202E-i5-R10	24" TFT Full HD 16:9 Display Modular and Expandable Panel PC with 12th Gen. Intel® Core™ i5-1245UE Processor and without Touch
CV-W124R-R10/P2202-i3-R10	24" TFT Full HD 16:9 Display Modular Panel PC with 12th Gen. Intel® Core™ i3-1215UE Processor and Resistive 5-wire Touch
CV-W124R-R10/P2202E-i3-R10	24" TFT Full HD 16:9 Display Modular and Expandable Panel PC with 12th Gen. Intel® Core™ i3-1215UE Processor and Resistive 5-wire Touch
CV-W124C-R11/P2202-i3-R10	24" TFT Full HD 16:9 Display Modular Panel PC with 12th Gen. Intel® Core™ i3-1215UE Processor and Projected Capacitive Touch
CV-W124C-R11/P2202E-i3-R10	24" TFT Full HD 16:9 Display Modular and Expandable Panel PC with 12th Gen. Intel® Core™ i3-1215UE Processor and Projected Capacitive Touch
CV-W124G-R10/P2202-i3-R10	24" TFT Full HD 16:9 Display Modular Panel PC with 12th Gen. Intel® Core™ i3-1215UE Processor and without Touch
CV-W124G-R10/P2202E-i3-R10	24" TFT Full HD 16:9 Display Modular and Expandable Panel PC with 12th Gen. Intel® Core™ i3-1215UE Processor and without Touch=

Model Configuration

	CV-W124R	CV-W124C	CV-W124G	P2202(i3/i5)	P2202E(i3/i5)
CV-W124R/P2202	V	--	--	V	--
CV-W124C/P2202	--	V	--	V	--
CV-W124G/P2202	--	--	V	V	--
CV-W124R/P2202E	V	--	--	--	V
CV-W124C/P2202E	--	V	--	--	V
CV-W124G/P2202E	--	--	V	--	V

V : Compatible

Package Checklist





• CV-W124/P2202 Series Panel PC x1	• Thermal Pad x1
• Power Terminal Block x1	• Screw Pack x5
• Remote Power On/Off Terminal Block Connector x1	• Panel Mounting Kit x1
• DIO Terminal Block Connector x2	• DIN Rail Mounting Kit x1
• PCI / PCIe Card Installation Kit x1 (For P2202E Only)	

Optional Modules and Accessories

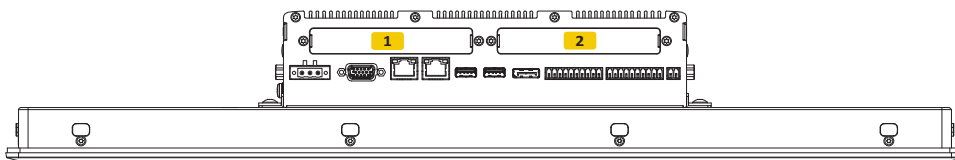
Model No.	Description
CFM-IGN101	CFM Module with Power Ignition Sensing Control Function, 12V/24V Voltage Detection Selectable
CFM-PoE04	CFM Module with PoE Control Function, Individual Port 25.5W (For P2202 Only)
CFM-PoE05	CFM Module with PoE Control Function, Individual Port 25.5W (For P2202E Only)
RC-E4-02	Riser Card with 1x PCIe x4 Slot (For P2202E Only)
RC-PI-02	Riser Card with 1x PCI Slot (For P2202E Only)
MEC-COM-M212-TDB9	Mini-PCIe Module with 2x RS-232 Ports, 1x Thin DB9 Cable (For P2202E Only)
MEC-COM-M334-TDB9	Mini-PCIe Module with 4x RS-232/422/485 Ports, 2x Thin DB9 Cable (For P2202E Only)
MEC-USB-M102-30	Mini-PCIe Module with 2x USB 3.0 Ports, 1x 30cm cable (For P2202E Only)
MEC-LAN-M102-30	Mini-PCIe Module with 2x LAN Ports, 2x 30cm cable (For P2202E Only)
UB1203	1x Universal Bracket with 2x DB9 Cutout (For P2202E Only)
UB1211	1x Universal Bracket with 2x RJ45 Cutout (For P2202E Only)
UB1214	1x Universal Bracket with 2x USB Cutout (For P2202E Only)
URM01	Universal 19" Rack Mount Kit for Industrial Panel PC & Industrial Monitor
GST60A12-CIN1	Adapter AC/DC 12V 5A 60W, GST60A12-CIN, wide temp (-30°C ~ +70°C), level VI
GST120A24-CIN	Adapter AC/DC 24V 5A 120W with 3pin Terminal Block Plug and Tubes, Level VI
GST220A24-CIN	Adapter AC/DC 24V 9.2A 220W with 3pin Terminal Block Plug 5.0mm Pitch, with TUBES, level VI (For P2202E Only)

Optional Module Configuration (For P2202E only)



Model No.	Description	1	2
 MEC-COM-M212-TDB9/UB1203	Mini-PCIe Module with 2x RS-232 Ports, 1x Thin DB9 Cable / 1x Universal Bracket with 2x DB9 Cutout	V	V
 MEC-COM-M334-TDB9/UB1203	Mini-PCIe Module with 4x RS-232/422/485 Serial Ports/ 2x Universal Bracket each with 2x DB9 Cutout	V	V
 MEC-LAN-M102-30/UB1211	Mini-PCIe Module with 2x LAN Ports, 2x 30cm cable / 1x Universal Bracket with 2x RJ45 Cutout	V	V
 MEC-USB-M102-30/UB1214	Mini-PCIe Module with 2x USB 3.2 Gen1 Ports, 1x 30cm cable / 1x Universal Bracket with 2x USB Cutout	V	V

V : Compatible