



# GP-3000 SERIES

## Industrial AI & Machine Vision Computer





- 01 | GP-3000 Series Introduction
- 02 | Embedded Computer Specification
- 03 | GPU Expansion Box Specification

# Dual GPU, Double Power

## Industrial AI & Machine Vision Computer



### 9<sup>th</sup> / 8<sup>th</sup> Gen Processor

Powered by 9/8th Generation Intel® Xeon®/Core™ Processor with Intel® C246 Chipset.

### Dual Full-length GPU

Support Maximum Dual 250W Nvidia / AMD GPU Cards Expansion Up to 328mm in Length

### 720W Power Budget

Offer 720W Total System Power Budget for High-end CPU&GPU Computing.

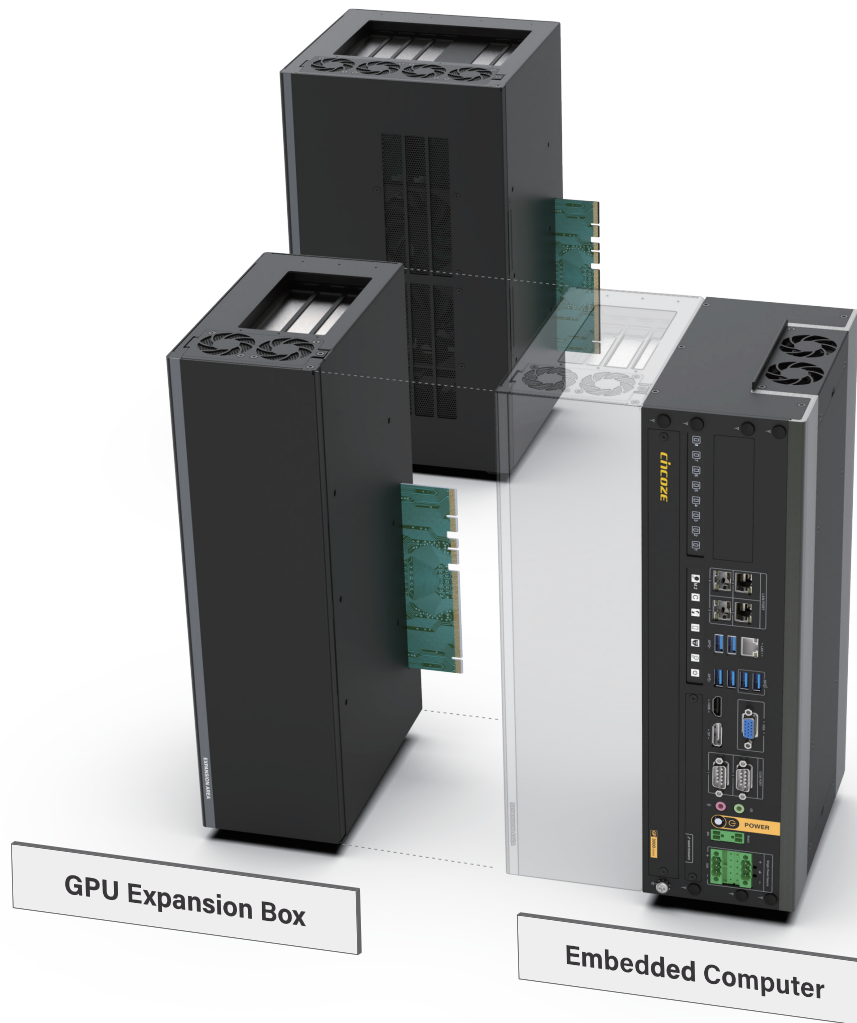

# Scalable Design

Patent No. I779496

Extremely powerful. And scalable. That’s what the GP-3000 series GPU computing system brings to the table. Its crowning achievement is the GPU expansion design. The GP-3000 is the core processing unit, and a selectable GPU Expansion Box (GEB) connects externally and supports up to dual high-end GPU cards. The GP-3000 series is a smart and high-performance GPU computing system.

## Multiple Expansion Options

Expansion is one of the primary advantages of the GP-3000. In addition to expanding the number of high-end GPU cards through the GEB, the expansion unit also provides multiple PCIe slots for other applications through high-speed I/O card or frame grabber card, etc. Easily customize the GP-3000 to meet the application needs of different markets.

## Upgrade Flexibility

Flexibility for future upgrades is a further advantage. Whether to increase the number of GPU cards or upgrade, there is no need to replace the embedded computer, replace the GEB. This approach dramatically reduces the upgrade cost and retains flexibility for future upgrades.



# Configuration Guide

**STEP 1**

Select an Embedded Computer



Embedded Computer

**STEP 2**

Select a GPU Expansion Box



GPU Expansion Box

+

=

**STEP 3**

Configure Your GPU Computer !



Embedded GPU Computer

## Overview

### Embedded Computer



**GP-3000 Series**

- High Performance Standalone Computer
- Support Cincoze' Innovative CMI & CFM Module Expansion
- Scalable Design by Adding Versatile GPU Expansion Box

### GPU Expansion Box



**GEB Series**

- Offer Various Combination of PCIe Slots for Add-on Cards Expansion
- Support Up to Dual 250W Full-length GPU Cards
- Intelligent Cooling Design for High-end GPU Card Thermal Optimization

# Mounting Type

## Desktop Mount



- Design for GP-3000 Embedded Computer Only
- With Standard Desktop Mount Bracket

## Face-up Mount



- Design for All GP-3000 Series:
  - GP-3000
  - GP-3000/GEB-33 Series
  - GP-3000/GEB-36 Series
- With Standard Wall Mount Bracket

## Wall Mount



- Design for All GP-3000 Series:
  - GP-3000
  - GP-3000/GEB-33 Series
  - GP-3000/GEB-36 Series
- With Standard Wall Mount Bracket

## 19" Rack Mount



- Design for All GP-3000 Series:
  - GP-3000
  - GP-3000/GEB-33 Series
  - GP-3000/GEB-36 Series
- With optional mounting kit:
  - RM01-R10 / RM02-R10 / RM03-R10

# GPU Card Dimension Guide

## GPU Card Maximum Dimension



## System Overview

GP-3000/GEB-33 Series

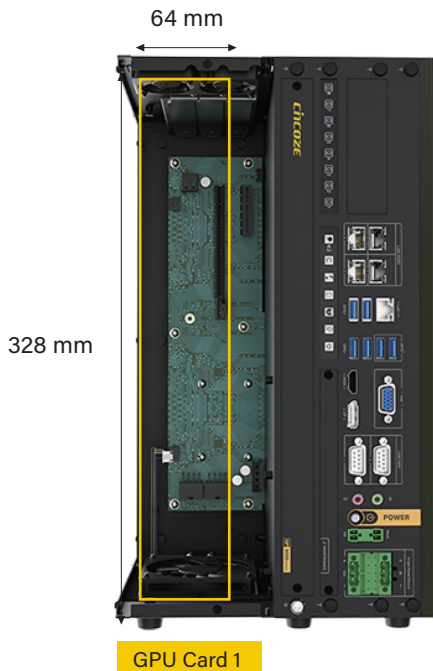

GP-3000/GEB-36 Series

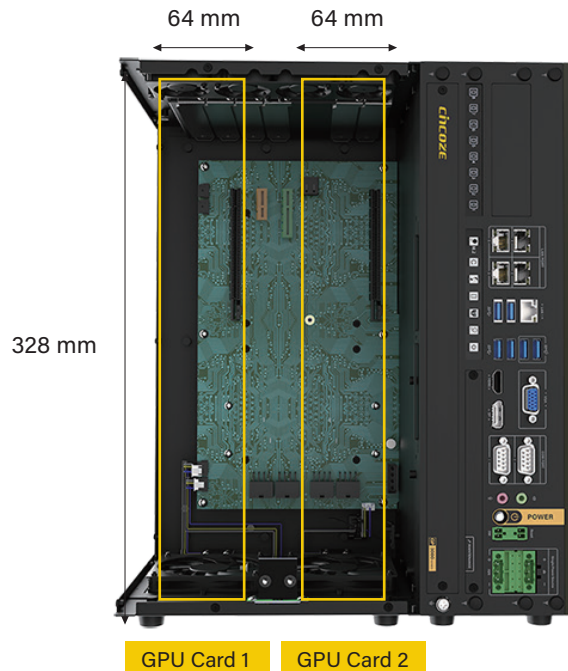



# Power Supply Cabling Guide

GP-3000 supports dual power connectors which are designed for single power source only. Dual power connect must be used at the same time due to 15A current limitation at each power connector.



## Item List





# Selection Guide

## Embedded Computer



Model Name	<b>GP-3000</b>
CPU	9 <sup>th</sup> /8 <sup>th</sup> Gen Intel® Xeon®/Core™
Chipset	C246
Memory	2 x SO-DIMM
2.5" Storage	4
Display	1 x VGA , 1 x HDMI , 1 x DP
LAN	5
USB	2 x USB 3.2 Gen2 , 4 x USB 3.2 Gen1
COM	2x RS-232/422/485
Remote Function	1 x Remote Power On/Off , 1 x Remote Reset
Mini PCIe	2
M.2	1 x M.2 Key M Type 2280 , 1 x M.2 Key E Type 2230
Internal USB	1 x USB 2.0
Power Input	9 - 48V
Total Power Budget	720W (with GEB-3601-R10)
Dimension ( W x D x H )	105 x 190 x 360 mm
EMC	CE / FCC / ICES-003 / EN50121-3-2 / E-mark
Safety	EN62368-1



## GPU Expansion Box



Model Name	GEB-3301	GEB-3601
PCIe x 16	1	2 ( PCIe x 8 Lanes )
PCIe x 4	1	1
PCIe x 1	-	1
Internal USB	1 x USB 2.0	1 x USB 2.0
GPU Card Power	2 x 8 Pin Power Connector	4 x 8 Pin Power Connector
Dimension ( W x D x H )	104 x 195 x 360 mm	200 x 195 x 360 mm

# Configuration Matrix



Model No.	GP-3000	GP-3000/GEB-3301	GP-3000/GEB-3601
<b>GP-3000</b> 	✓	✓	✓
<b>GEB-3301</b> 		✓	
<b>GEB-3601</b> 			✓

## Specifications

Weight Information	8 kg	11.2 kg
Dimension ( W x D x H )	105 x 195 x 370 mm	209 x 195 x 370 mm
Operating Temperature	-40°C to 70°C (Please see page 14 for more information)	
Storage Temperature	40°C to 85°C	
Relative Humidity	95% RH @ 70°C (Non-condensing)	
Mounting	Wall / Desktop / 19" Rack Mount / Stand Mount ( Please see page 6 for more information)	
Shock	MIL-STD-810G	
Vibration	MIL-STD-810G	
EMC	CE, FCC, ICES-003 Class A, EN50121-3-2 (Railway), E-mark	



- 01 | GP-3000 Series Introduction
- 02 | Embedded Computer Specification
- 03 | GPU Expansion Box Specification

# GP-3000

Dual Full-length GPU Expandable Computer



## Overview

GP-3000. A flagship GPU edge computing computer of Cincoze. Its crowning feature is an exclusive GPU Expansion Box that provides expansion for up to two high-end GPU cards and creating a high-performance industrial-grade GPU computing computer.

### Extreme Computing Performance

The GP-3000's extreme computing power starts with an 8th or 9th generation Intel® Xeon® or Core™ i3/i5/i7 (Coffee Lake and Coffee Lake-R) CPU, Intel® C246 chipset, and supports two sets of DDR4-2666 ECC/non-ECC SO-DIMM up to 128 GB and can support up to two 250 W high-end GPU cards. With a total power consumption of 720W, it's easy to meet and exceed high-efficiency application requirements. A precision heat dissipation and cooling design quickly wick away heat, keeping the focus squarely on the breathtaking performance of the GP-3000.

### Rich Application Functions

The GP-3000 redefines the standard for high-end GPU computers, with high-speed I/O and multiple functions. In addition to the standard five LAN ports and six USB 3.2 ports, the GP-3000 uses Cincoze's exclusive CMI and CFM modular design, which offers expansion modules with eight Gigabit PoE, two USB 3.2, or dual 10 Gb/s LAN ports. Storage options include high-speed M.2 NVMe storage slots and four hot-swappable 2.5" HDD/SSD trays accessible through the front maintenance panel. Together, they meet large-capacity machine vision storage requirements and improve hard disk accessibility for convenient removal and replacement. The IGN module (power ignition sensing) can monitor the on-board battery voltage and set a delayed shutdown time to avoid damage to the system due to unstable current when starting or turning off the engine. This combination of diverse functions provides the flexibility to meet the requirements of different market applications.

### Strong and Reliable

In the pursuit of ever-higher standards, the GP-3000 has passed the MIL-STD-810G certification designed and promulgated by the US Department of Defense to qualify military equipment. The GP-3000 features 9~48 VDC power input, is built for -40 to 70°C temperature operation. The GP-3000 has E-mark and EN50155 (EN50121-3-2 only) certifications, so it is capable of withstanding the rigors of rail and vehicle applications as well as other harsh environments.

## Key Features

- Supports 9th/8th Gen Intel® Xeon®/Core™ Processor (35W / 65W / 80W)
- 2 x DDR4 SO-DIMM Sockets, Supports ECC/non ECC type up to 2666 MHz, 64GB
- 4 x 2.5" Hot Swappable SATA III HDD/SSD Bays (Max Height 15 mm)
- 1 x M.2 M Key Socket (NVMe), 1 x M.2 E Key Socket (CNVi)
- 2 x Front Accessible SIM Card Slots for Signal Redundancy
- CMI Technology for Various I/O Module Expansions
- CFM Technology for Power Ignition Sensing & PoE Function
- Versatile Mounting Methods (Wall / Desktop / Face-up / 19" Rack Mount)
- Military Standard Shock & Vibration Proof

## Certifications





### Cutting-Edge Performance

The GP-3000 is powered by the excellent performance of 8th / 9th generation Intel® Xeon® / Core™ processors. Supports two DDR4 SO-DIMM ECC/Non-ECC memory, up to 128GB. Through the exclusive GPU Expansion Box (GEB) design can flexibly expand up to dual high-end GPU cards. And GP-3000 offers 720W system power budget for high-end GPU Computing applications.



### Futureproof Scalability

Upgrades are now easy. In addition to GPU expansion through the GEBs, the GP-3000 also retains flexibility for future upgrades. Whether adding or upgrading GPU cards, the core system remains, and only the GEB is changed. Upgrades become easier, and the expansion possibilities become almost endless.

### Mount Anywhere

The GP-3000 supports multiple mounting options for various environment. Mounting options include a wall mount, desktop mount, Face-up mount, and 19" rack mount. Simple.



## Specifications

Model Name	GP-3000
<b>System</b>	
Processor	<ul style="list-style-type: none"> <li>9th Generation Intel Coffee Lake-R S Series CPU:               <ul style="list-style-type: none"> <li>- Intel® Xeon® E-2278GE 8 Cores Up to 4.7 GHz, TDP 80W</li> <li>- Intel® Xeon® E-2278GEL 8 Cores Up to 3.9 GHz, TDP 35W</li> <li>- Intel® Core™ i7-9700E 8 Cores Up to 4.4 GHz, TDP 65W</li> <li>- Intel® Core™ i5-9500E 6 Cores Up to 4.2 GHz, TDP 65W</li> <li>- Intel® Core™ i3-9100E 4 Cores Up to 3.7 GHz, TDP 65W</li> <li>- Intel® Core™ i7-9700TE 8 Cores Up to 3.8 GHz, TDP 35W</li> <li>- Intel® Core™ i5-9500TE 6 Cores Up to 3.6 GHz, TDP 35W</li> <li>- Intel® Core™ i3-9100TE 4 Cores Up to 3.2 GHz, TDP 35W</li> </ul> </li> <li>8th Generation Intel Coffee Lake S Series CPU:               <ul style="list-style-type: none"> <li>- Intel® Xeon® E-2176G 6 Cores up to 4.7 GHz, TDP 80W</li> <li>- Intel® Xeon® E-2124G 4 Cores up to 4.5 GHz, TDP 71W</li> <li>- Intel® Core™ i7-8700 6 Cores up to 4.6 GHz, TDP 65W</li> <li>- Intel® Core™ i5-8500 6 Cores, up to 4.1 GHz, TDP 65W</li> <li>- Intel® Core™ i3-8100 4 Cores 3.6 GHz, TDP 65W</li> <li>- Intel® Core™ i7-8700T 6 Cores up to 4.0 GHz, TDP 35W</li> <li>- Intel® Core™ i5-8500T 6 Cores up to 3.5 GHz, TDP 35W</li> <li>- Intel® Core™ i3-8100T 4 Cores 3.1 GHz, TDP 35W</li> <li>- Intel® Pentium® G5400 2 Cores 3.7 GHz, TDP 58W</li> <li>- Intel® Pentium® G5400T 2 Cores 3.1 GHz, TDP 35W</li> <li>- Intel® Celeron® G4900 2 Cores 3.1 GHz, TDP 54W</li> <li>- Intel® Celeron® G4900T 2 Cores 2.9 GHz, TDP 35W</li> </ul> </li> </ul>
Chipset	<ul style="list-style-type: none"> <li>Intel® C246</li> </ul>
BIOS	<ul style="list-style-type: none"> <li>AMI BIOS</li> </ul>
Memory	<ul style="list-style-type: none"> <li>2x DDR4 2666/2400 MHz SO-DIMM Sockets</li> <li>* Xeon/i7/i5: Up to DDR4 2666MHz</li> <li>* i3/Pentium/Celeron: Up to DDR4 2400MHz</li> <li>Supports ECC / non-ECC Type Up to 64GB</li> </ul>
<b>Graphics</b>	
Graphics Engine	<ul style="list-style-type: none"> <li>Integrated Intel® UHD Graphics (Xeon/i7/i5/i3: UHD 630; Pentium/Celeron: UHD 610)</li> <li>Supports Triple Independent Display (VGA/DisplayPort/HDMI)</li> </ul>
<b>Audio</b>	
Audio Codec	<ul style="list-style-type: none"> <li>Realtek® ALC888, High Definition Audio</li> </ul>
<b>I/O</b>	
DisplayPort	<ul style="list-style-type: none"> <li>1x DisplayPort Connector (4096 x 2304 @ 60Hz, According to CPU Specifications)</li> <li>* Verified maximum resolution: 3840x2160.</li> </ul>
HDMI	<ul style="list-style-type: none"> <li>1x HDMI Connector (4096 x 2160 @30Hz)</li> </ul>
VGA	<ul style="list-style-type: none"> <li>1x VGA Connector (1920 x 1200 @30Hz )</li> </ul>
LAN	<ul style="list-style-type: none"> <li>5x GbE LAN, RJ45               <ul style="list-style-type: none"> <li>- GbE1: Intel® I219-LM</li> <li>- GbE2: Intel® I210</li> <li>- GbE3: Intel® I210</li> <li>- GbE4: Intel® I210</li> <li>- GbE5: Intel® I210</li> </ul> </li> </ul>
COM	<ul style="list-style-type: none"> <li>2x RS-232/422/485 with Auto Flow Control (Supports 5V/12V), DB9</li> </ul>
USB	<ul style="list-style-type: none"> <li>2x 10Gbps USB 3.2 Gen2, Type A</li> <li>4x 5Gbps USB 3.2 Gen1, Type A</li> </ul>
Line-out	<ul style="list-style-type: none"> <li>1x Line-out, Phone Jack 3.5mm</li> </ul>
Mic-in	<ul style="list-style-type: none"> <li>1x Mic-in, Phone Jack 3.5mm</li> </ul>
Power On/Off Switch Button	<ul style="list-style-type: none"> <li>1x ATX Power On/Off Button</li> </ul>

CMOS Switch	<ul style="list-style-type: none"> <li>• 1x Clear CMOS Switch</li> </ul>
Remote Power On/Off Connector	<ul style="list-style-type: none"> <li>• 1x Remote Power On/Off Connector, 2-Pin Terminal Block</li> </ul>
Terminal Block	<ul style="list-style-type: none"> <li>• 1x Remote Reset, 2-pin Terminal Block</li> </ul>
AT/ATX Mode Switch	<ul style="list-style-type: none"> <li>• 1x AT/ATX Mode Switch</li> </ul>
Reset Button	<ul style="list-style-type: none"> <li>• 1x Reset Button</li> </ul>
<b>Storage</b>	
SSD / HDD	<ul style="list-style-type: none"> <li>• 4x 2.5" Front Accessible SATA HDD/SSD Bay (SATA 3.0), Supports Up to 15mm in Height</li> </ul>
M.2	<ul style="list-style-type: none"> <li>• 1x M.2 Key M 2280 Socket, Supports PCIe x4 NVMe SSD or SATA SSD (Gen3)</li> </ul>
RAID	<ul style="list-style-type: none"> <li>• Supports RAID 0 / 1 / 5 / 10</li> </ul>
<b>Expansion</b>	
PCIe	<ul style="list-style-type: none"> <li>• Optional GPU Expansion Box</li> <li>- 1 x PCIe x 4 + 1 x PCIe x 16</li> <li>- 2 x PCIe x 16 (8 Lanes) + 1 x PCIe x 1 + 1 x PCIe x 4</li> <li>* Please See "Chapter 3 – GPU Expansion Box Specification" for more information.</li> </ul>
Mini-PCIe Socket	<ul style="list-style-type: none"> <li>• 2x Full-size Mini-PCIe Socket</li> </ul>
M.2	<ul style="list-style-type: none"> <li>• 1x M.2 Key E 2230 Socket, Supports Intel CNVi Module</li> <li>• 1x M.2 Key M 2280 Socket, Support NVMe/SATA SSD</li> </ul>
Universal Bracket	<ul style="list-style-type: none"> <li>• 1x Universal Bracket</li> </ul>
SIM Socket	<ul style="list-style-type: none"> <li>• 2x SIM Socket</li> </ul>
Antenna Holes	<ul style="list-style-type: none"> <li>• 7x Antenna Holes</li> </ul>
CMI (Combined Multiple I/O) Interface	<ul style="list-style-type: none"> <li>• CMI Interface</li> <li>1 x High Speed CMI (Combined Multiple I/O) Interface</li> <li>1 x Low Speed CMI (Combined Multiple I/O) Interface</li> <li>• CMI Module</li> <li>Optional Modules:</li> <li>- 4x GbE LAN, RJ45</li> <li>- 4x GbE LAN, M12 A-Coded</li> <li>- 4x GbE LAN, M12 X-Coded</li> <li>- 2x 10GbE LAN, RJ45</li> <li>- 2x RS-232/422/485 with Auto Flow Control (Supports 5V/12V), DB9</li> <li>- 16x Optical Isolated DIO(8DI, 8DO), 2x 10 Pin Terminal Block</li> <li>• 1x CFM IGN Interface</li> <li>- CFM-IGN01: Ignition Sensing Function</li> </ul>
CFM (Control Function Module) Interface	<ul style="list-style-type: none"> <li>• CFM Interface</li> <li>1x CFM(Control Function Module) IGN Interface</li> <li>1x CFM(Control Function Module) PoE Interface</li> <li>• CFM Module</li> <li>Optional Module</li> <li>- 1x Power Ignition Sensing Module with Delay Time Management and Selectable 12V/24V</li> <li>- 1x PoE Function Module Supports Up to 4x PoE+ with Individual port 25.5W</li> </ul>
MEC Module	<ul style="list-style-type: none"> <li>• Optional Modules:</li> <li>- 2x 5Gbps USB 3.2 Gen1, Type A</li> <li>- 2x GbE LAN, RJ45</li> </ul>
<b>Other Function</b>	
Fan Kits	<ul style="list-style-type: none"> <li>• 2x Fan Kits ( Air-flow isolated from the electronics )</li> </ul>
Instant Reboot	<ul style="list-style-type: none"> <li>• Support 0.2 sec. Instant Reboot Technology</li> </ul>
CMOS Battery	<ul style="list-style-type: none"> <li>• SuperCap Integrated for CMOS Battery Maintenance-free Operation</li> </ul>
WatchDog Timer	<ul style="list-style-type: none"> <li>• Software Programmable Supports 256 Levels System Reset</li> </ul>

<b>Power Requirement</b>																					
Power Type	• AT / ATX																				
Total Power Budget	• 720W (with GEB-3601-R10)																				
Power Supply Voltage	• 9~48VDC, Single Power Source																				
Connector Type	• 2x 3-pin Terminal Block, Each Terminal Block Current Limitation is 15A																				
Power Supply	• Optional AC/DC or DC/DC 24V 480W Power Supply • Optional AC/DC or DC/DC 24V 1000W Power Supply																				
<b>Physical</b>																					
Dimension ( W x D x H )	• 105 x 195 x 370 mm																				
Weight	• 8 kg																				
Construction	• Extruded Aluminum with Heavy Duty Metal																				
Mounting	• Wall Mount / Desktop Mount / 19" Rack Mount / Face-up Mount																				
Physical Design	• Unibody Chassis • Jumper-less Design																				
<b>Protection</b>																					
Reverse Power Input Protection	• Yes																				
Over Voltage Protection	• Protection Range: 51~58V • Protection Type: shut down operating voltage, re-power on at the preset level to recover																				
Over Current Protection	• 30A																				
<b>Operating System</b>																					
Windows	• Windows® 10																				
Linux	• Supports by Project																				
<b>Environment</b>																					
Operating Temperature	<table border="1"> <thead> <tr> <th>CPU \ GPU</th> <th>Non-GPU</th> <th>1 x 250W GPU</th> <th>1 x 300W GPU</th> <th>2 x 250W GPU</th> </tr> </thead> <tbody> <tr> <td>35W</td> <td>-40°C to 70°C</td> <td>-40°C to 40°C</td> <td>-40°C to 35°C</td> <td>-40°C to 35°C</td> </tr> <tr> <td>65W</td> <td>-40°C to 60°C</td> <td>-40°C to 40°C</td> <td>-40°C to 35°C</td> <td>-40°C to 35°C</td> </tr> <tr> <td>80W</td> <td>-40°C to 50°C</td> <td>-40°C to 40°C</td> <td>-40°C to 35°C</td> <td>-40°C to 35°C</td> </tr> </tbody> </table> <p>* With extended temperature peripherals; Ambient with air flow * According to IEC60068-2-1, IEC60068-2-2, IEC60068-2-14 * 100% CPU and GPU without thermal throttling</p>	CPU \ GPU	Non-GPU	1 x 250W GPU	1 x 300W GPU	2 x 250W GPU	35W	-40°C to 70°C	-40°C to 40°C	-40°C to 35°C	-40°C to 35°C	65W	-40°C to 60°C	-40°C to 40°C	-40°C to 35°C	-40°C to 35°C	80W	-40°C to 50°C	-40°C to 40°C	-40°C to 35°C	-40°C to 35°C
CPU \ GPU	Non-GPU	1 x 250W GPU	1 x 300W GPU	2 x 250W GPU																	
35W	-40°C to 70°C	-40°C to 40°C	-40°C to 35°C	-40°C to 35°C																	
65W	-40°C to 60°C	-40°C to 40°C	-40°C to 35°C	-40°C to 35°C																	
80W	-40°C to 50°C	-40°C to 40°C	-40°C to 35°C	-40°C to 35°C																	
Storage Temperature	• -40°C to 85°C																				
Relative Humidity	• 95% RH @ 70°C (Non-condensing)																				
Shock	• MIL-STD-810G																				
Vibration	• MIL-STD-810G																				
MTBF	• 441,283hr																				
Fire Protection	• Fire Protection: EN 45545-2																				
EMC	• CE, UKCA, FCC, ICES-003 Class A • EN 50155 (EN 50121-3-2 Only) • E-mark																				



EMI	<ul style="list-style-type: none"> <li>• CISPR 32 Conducted &amp; Radiated: Class A</li> <li>• EN/BS EN 50121-3-2 Conducted &amp; Radiated: Class A</li> <li>• EN/BS EN IEC 61000-3-2 Harmonic current emissions: Class A</li> <li>• EN/BS EN61000-3-3 Voltage fluctuations &amp; flicker</li> <li>• FCC 47 CFR Part 15B, ICES-003 Conducted &amp; Radiated: Class A</li> </ul>
EMS	<ul style="list-style-type: none"> <li>• EN/IEC 61000-4-2 ESD: Contact: 6 kV; Air: 8 kV</li> <li>• EN/IEC 61000-4-3 RS: 80 MHz to 1000 MHz: 20 V/m</li> <li>• EN/IEC 61000-4-4 EFT: AC Power: 2 kV; Signal: 2 kV</li> <li>• EN/IEC 61000-4-5 Surges: AC Power: 2 kV</li> <li>• EN/IEC 61000-4-6 CS: 10V</li> <li>• EN/IEC 61000-4-8 PFMF: 50 Hz, 1A/m</li> <li>• EN/IEC 61000-4-11 Voltage Dips &amp; Voltage Interruptions: 0.5 cycles at 50 Hz</li> </ul>
Safety	<ul style="list-style-type: none"> <li>• LVD IEC/EN 62368-1</li> </ul>

## External Layout

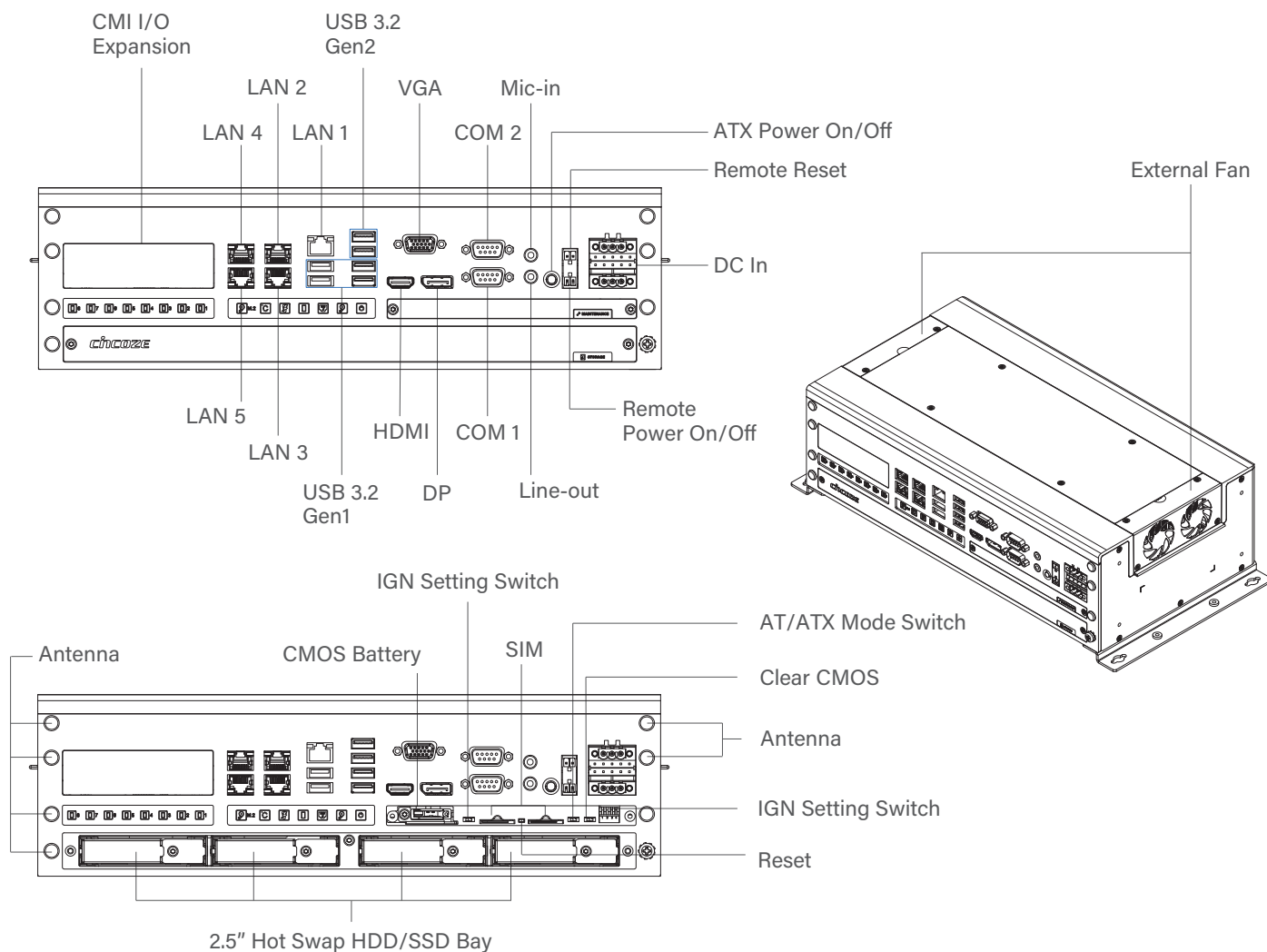

## Dimensions

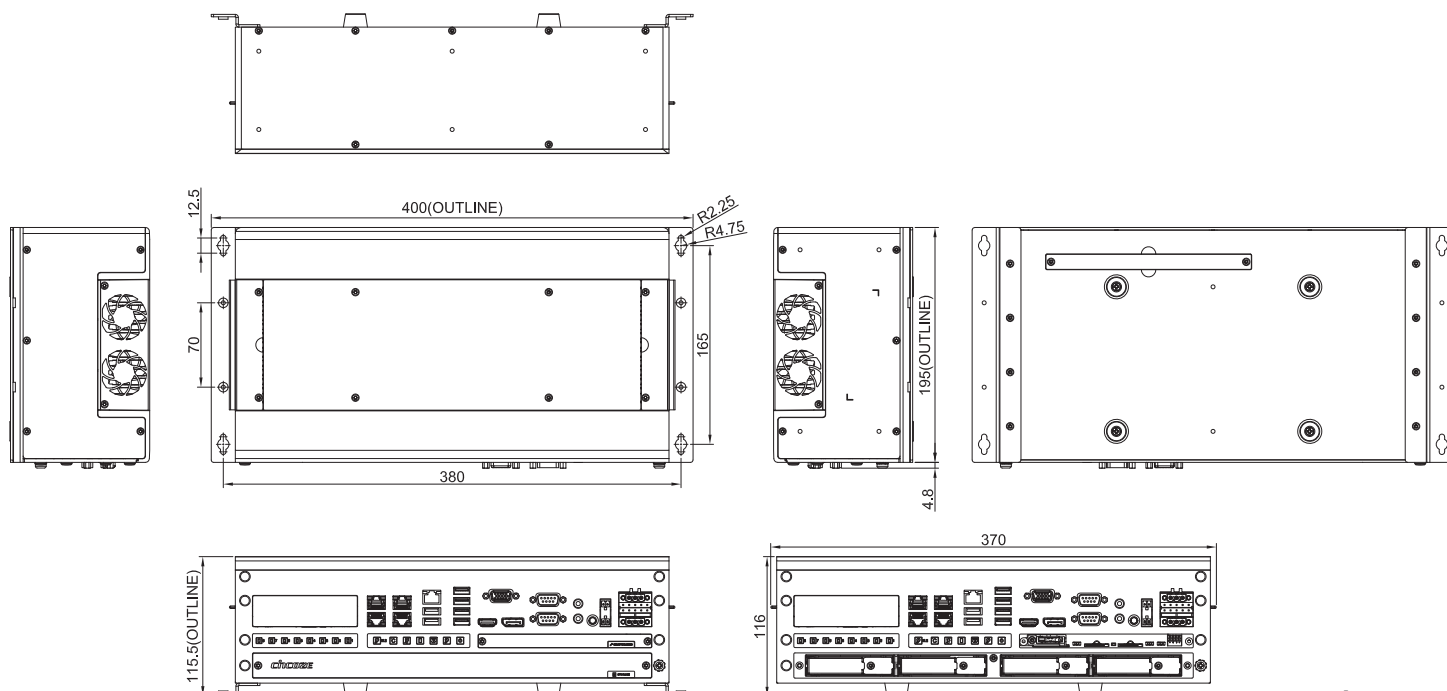







Unit: mm

## Ordering Information

### Available Models



<p><b>GP-3000-R10</b></p> 	<p>9th/8th Gen Intel® Xeon®/Core™ GPU Computer, Supports Dual Full-length GPU Expansion Up to 500W</p>
---	--

### Package Checklist

	<p>Wall Mount Bracket</p>
	<p>1 x Desktop Mount Kit</p>
	<p>CPU Heatsink and Thermal Pad Kit</p>
 <p>x 6    x 2 x 16    x 4</p>	<p>4 x Screw Pack</p>
	<p>1 x Rubber Foot Kit</p>
	<p>2 x Power Terminal Block Connector</p>
	<p>2 x Remote Function Terminal Block Connector</p>





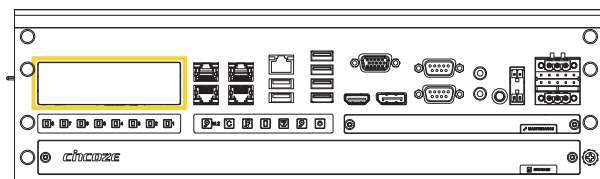

## Optional Module

### Available Models

<p><b>GEB-3301-R10</b></p> 	<p>GPU Expansion Box with 1x PCIe x16 and 1x PCIe x4 Slots for GP-3000 Series</p>
<p><b>GEB-3601-R10</b></p> 	<p>GPU Expansion Box with 2x PCIe x16 (Signal PCIe x8), 1x PCIe x4 and 1x PCIe x1 Slots for GP-3000 Series</p>

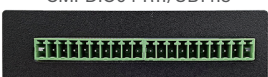

### Available Models





Model No.	Description
<p>CMI-LAN01-R12/UB1412</p> 	<p>CMI Module with 4x Intel I210 GbE LAN, RJ45 Port / 1x Universal Bracket with 4x RJ45 Cutout for GP-3000 Series</p>
<p>CMI-M12LAN01-R12/UB1410</p> 	<p>CMI Module with M12 A-Coded Connector, 4x Intel I210 GbE LAN / 1x Universal Bracket with 4x M12 Cutout for GP-3000 Series</p>
<p>CMI-XM12LAN01-R10/UB1410</p> 	<p>CMI Module with M12 X-Coded Connector, 4x Intel I210 GbE LAN Ports / Universal Bracket with 4x M12 Cutout for GP-3000 Series</p>
<p>CMI-10GLAN02-R10/UB1428</p> 	<p>CMI Module with 2x Intel X550 10GbE LAN, RJ45 Port / 1x Universal Bracket with 2x RJ45 Cutout for GP-3000 Series</p>
<p>CMI-COM04-R10/UB1403</p> 	<p>CMI Module with 2x RS232/422/485 Ports (Support 5V/12V) / 1x Universal Bracket with 2x DB9 Cutout for GP-3000 Series</p>
<p>CMI-DIO04-R11/UB1418</p> 	<p>CMI Module with 16DIO (8in 8out) / 1x Universal Bracket with DIO Cutout for GP-3000 Series</p>
<p>MEC-USB-M102-30/UB1414</p> 	<p>Mini-PCIe Module with 2x USB 3.2 Gen1 Ports, 1x30 cm cable, 1x Universal Bracket with 2x USB Cutout</p>

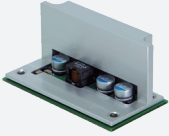
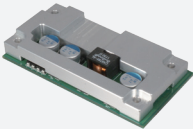





**Accessories - Function Module**

<p><b>CFM-PoE07-R10</b></p> 	<p>CFM Module with PoE Function, Individual Port 25.5W (Enable PoE function for CMI-LAN01-R12, CMI-M12LAN01-R12, CMI-XM12LAN01-R10)</p>
<p><b>CFM-PoE01</b></p> 	<p>CFM Module with PoE Function, Individual Port 25.5W (Enable PoE function for onboard LAN 2 to LAN 5)</p>
<p><b>CFM-IGN03-R10</b></p> 	<p>CFM Module with Power Ignition Sensing Function, 12V/24V Selectable</p>

**Mounting Kit**

<p><b>RM01-R10</b></p> 	<p>19" Rack Mount Kit for GP-3000</p>
<p><b>RM02-R10</b></p> 	<p>19" Rack Mount Kit for GP-3000/GEB-33 Series</p>
<p><b>RM03-R10</b></p> 	<p>19" Rack Mount Kit for GP-3000/GEB-36 Series</p>

**Power Supply / Power Cord / Power Cable**

	<p>DIN Rail Power Supply 480W 24V, SDR-480-24</p>
	<p>Power Supply 1000W 24V, HEP-1000-24</p>
	<p>1.8M US Power Cord, Stripped and Tinned End with Tube</p>
	<p>1.8M EU Power Cord, Stripped and Tinned End with Tube</p>
	<p>1M Power Cable with 3-Pin Terminal Block Plug, Stripped and Tinned End with Tube</p>



- 01 | GP-3000 Series Introduction
- 02 | Embedded Computer Specification
- 03 | GPU Expansion Box Specification

# GEB-3301

GPU Expansion Box with 1 x PCIe x16 and 1 x PCIe x4 Slots for GP-3000 Series

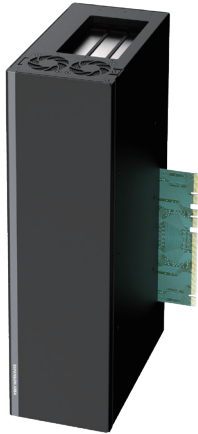

- Supports NVIDIA RTX 30 Series GPU Card
- Support 1 x PCIe x16 Slot for full-length GPU card Expansion
- Support 1 x PCIe x4 Slot for Add-on card Expansion
- Intelligent Cooling Design for High Performance GPU Card
- Military Standard Shock & Vibration Proof
- Designed with adjustable GPU card retainer (TW Patent Certificate No: I763318) (US Patent Certificate No: US 11,470,738 B2)



## Specifications

Expansion Slot	<ul style="list-style-type: none"> <li>• 1 x PCIe x 16 Slot for GPU Card</li> <li>• 1 x PCIe x 4 Slot</li> </ul>
GPU Card Dimension	<ul style="list-style-type: none"> <li>• Card Length : 328mm</li> <li>• Card Height : 64mm ( Standard Triple-Deck )</li> <li>• Card Width : 138mm</li> </ul>
Internal USB	<ul style="list-style-type: none"> <li>• 1 x USB 2.0, Type A</li> </ul>
Internal Power Connector	<ul style="list-style-type: none"> <li>• 2 x 8-Pin Connector for GPU Card</li> </ul>
Total Power Budget	<ul style="list-style-type: none"> <li>• 350W</li> </ul>
Weight Information	<ul style="list-style-type: none"> <li>• 3.2 kg</li> </ul>
Dimension ( W x D x H )	<ul style="list-style-type: none"> <li>• 104 x 195 x 360 mm</li> </ul>
MTBF	<ul style="list-style-type: none"> <li>• 2,713,254 hr</li> </ul>

## Dimensions

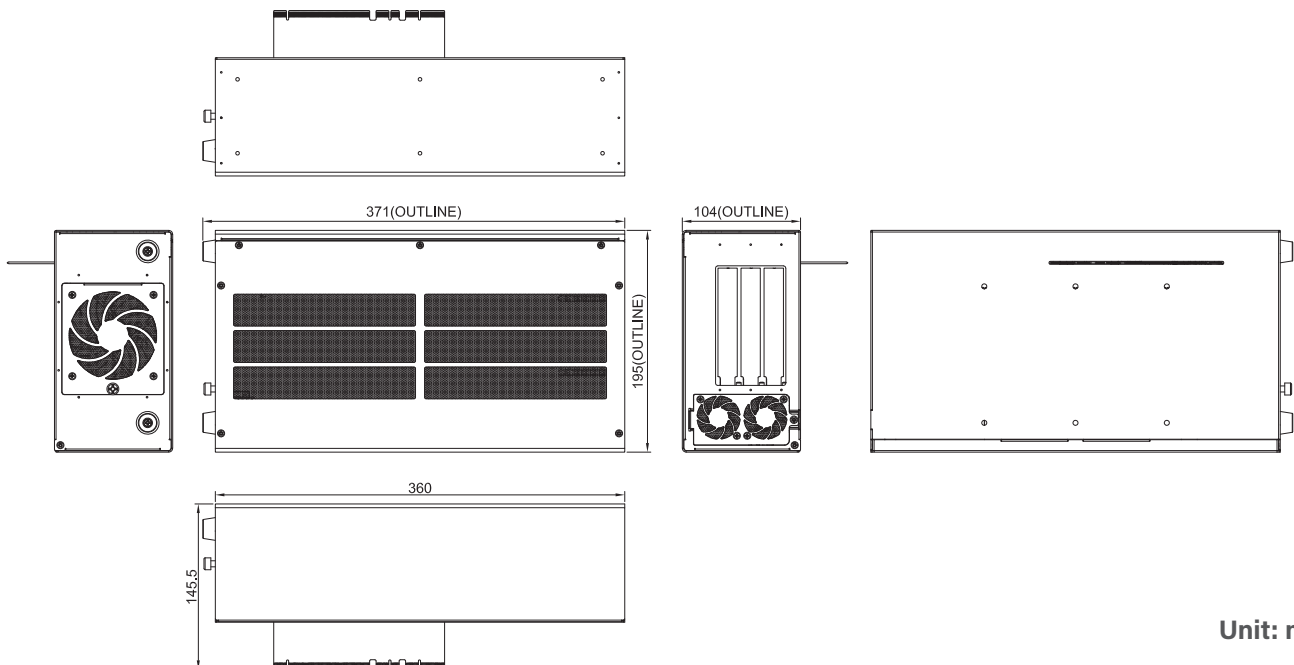







Unit: mm

## Ordering Information

### Available Models

<p><b>GEB-3301-R10</b></p> 	<p>GPU Expansion Box with 1 x PCIe x 16 and 1 x PCIe x 4 Slots for GP-3000 Series</p>
--	---

### Package Checklist

	<p>Wall Mount Bracket</p>
	<p>2 x 8 Pin to 6+2 Pin GPU Power Cable</p>
	<p>2 x Screw Pack</p>
	<p>1 x GPU Card Retainer Screw Pack</p>
	<p>1 x Rubber Foot Kit</p>
	<p>2 x Sponge</p>



# GEB-3601

GPU Expansion Box with 2 x PCIe x16 (Signal PCIe x8), 1 x PCIe x4 and 1 x PCIe x1 Slots for GP-3000 Series

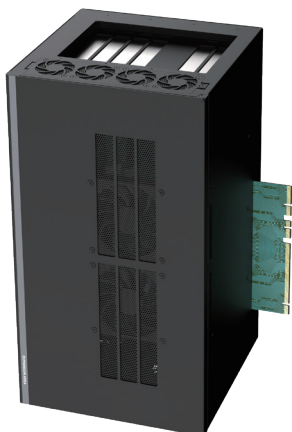

- Supports NVIDIA RTX 30 Series GPU Card
- Supports 2 x PCIe x16 Slots for full-length GPU cards Expansion
- Supports 1 x PCIe x4 Slot and 1 x PCIe x1 slot for Add-on cards
- Intelligent Cooling Design for High Performance GPU Card
- Military Standard Shock & Vibration Proof
- Designed with adjustable GPU card retainer (TW Patent Certificate No: I763318) (US Patent Certificate No: US 11,470,738 B2)



## Specifications

Expansion Slot	<ul style="list-style-type: none"> <li>• 2 x PCIe x 16 Slot ( PCIe x 8 Signal ) for GPU Card</li> <li>• 1 x PCIe x 4 Slot</li> <li>• 1 x PCIe x 1 Slot</li> </ul>
GPU Card Dimension	<ul style="list-style-type: none"> <li>• Card Length: 328mm</li> <li>• Card Height: 64mm ( Standard Triple-Deck )</li> <li>• Card Width: 138mm</li> </ul>
Internal USB	<ul style="list-style-type: none"> <li>• 1 x USB2.0, Type A</li> </ul>
Internal Power Connector	<ul style="list-style-type: none"> <li>• 4 x 8-Pin Connector for GPU Card</li> </ul>
Total Power Budget	<ul style="list-style-type: none"> <li>• 500W</li> </ul>
Weight Information	<ul style="list-style-type: none"> <li>• 5.2 kg</li> </ul>
Dimension ( W x D x H )	<ul style="list-style-type: none"> <li>• 200 x 195 x 360 mm</li> </ul>
MTBF	<ul style="list-style-type: none"> <li>• 1,661,177 hr</li> </ul>

## Dimensions

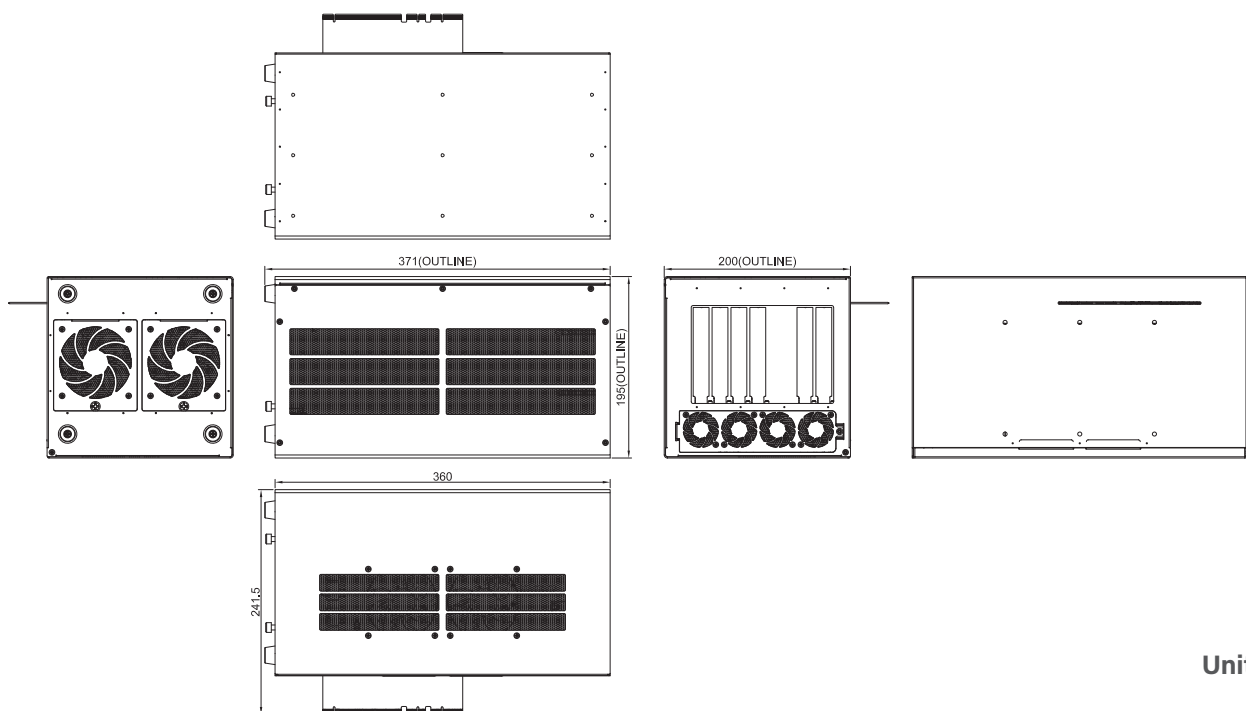







Unit: mm

## Ordering Information

### Available Models

<p><b>GEB-3601-R10</b></p> 	<p>GPU Expansion Box with 2 x PCIe x 16 (Signal PCIe x 8), 1 x PCIe x 4 and 1 x PCIe x 1 Slots for GP-3000 Series</p>
--	---

### Package Checklist

	<p>Wall Mount Bracket</p>
	<p>4 x 8 Pin to 6+2 Pin GPU Power Cable</p>
 <p>x 9    x 6</p>	<p>2 x Screw Pack</p>
 <p>x 2    x 2 x 4    x 4</p>	<p>1 x GPU Card Retainer Screw Pack</p>
	<p>1 x Rubber Foot Kit</p>
	<p>4 x Sponge</p>