



## ViTAM-1XX Series

10.1", 12.1", 15", 15.6", 17", 19", 21.5", and 23.8" New Gen. IP66/IP69K  
Stainless Steel Display

### User Manual

#### Release Date

July. 2019

#### Revision

V1.7

©2019 Aplex Technology, Inc.

All Rights Reserved.

Published in Taiwan

Aplex Technology, Inc.

15F-1, No.186, Jian Yi Road, Zhonghe District, New Taipei City 235, Taiwan

Tel: 886-2-82262881 Fax: 886-2-82262883 URL: <http://www.aplextec.com/zh/home.php>

# Revision History

Reversion	Date	Description
0.1	2016/12/14	For Preliminary Release
0.2	2016/12/22	Update power consumption and net weight
1.0	2017/01/10	Official Version
1.1	2017/03/07	Revised VESA mounting size
1.2	2017/07/28	Add I/O drawing and definition
1.3	2018/02/14	LCD description
1.4	2018/11/01	Revise Operatiing temperature+LCD size
1.5	2018/11/22	Revise Backlight Lifetime information
1.6	2019/01/11	Revise MB information
1.7	2019/07/29	Add Logistic Statement

# Warning!

---

This equipment generates, uses and can radiate radio frequency energy and if not installed and used in accordance with the instructions manual, it may cause interference to radio communications. It has been tested and found to comply with the limits for a Class A computing device pursuant to FCC Rules, which are designed to provide reasonable protection against such interference when operated in a commercial environment. Operation of this equipment in a residential area is likely to cause interference in which case the user at his own expense will be required to take whatever measures may be required to correct the interference.

Electric Shock Hazard – Do not operate the machine with its back cover removed. There are dangerous high voltages inside.

## Disclaimer

**This information in this document is subject to change without notice. In no event shall Apex Technology Inc. be liable for damages of any kind, whether incidental or consequential, arising from either the use or misuse of information in this document or in any related materials.**

Dear Valued Partners

Thank you for supporting APLEX Technology. Kindly note for ViTAM series, the pressure testing screw is loosen for half turn before shipment. The purpose is to avoid potential quality concerns caused by radical air pressure change during transportation. This especially applies to air shipment with unpressurized cabin.

Upon receiving the system, please tighten the pressure testing screw before deployment to ensure 100% functionality.

Here is our suggestion:

1. Prepare a 3mm hex screwdriver
2. Tighten the screw (indicated in circle) clockwise until it is well in place
3. Recommend torque is 8~10 kgf-cm

Apologies for any inconveniences caused and thank you for your cooperation.

Yours Sincerely



# Table of Contents

Revision History.....	1
Warning!.....	2
Disclaimer.....	2
Logistic Statement.....	3

## Chapter 1 Getting Started

1.1 Features.....	6
1.2 Specifications.....	6
1.3 Dimensions.....	12
1.4 Brief Description of ViTAM-1XX Series.....	16

## Chapter 2 OSD

2.1 AD Board OSD Functions.....	20
2.2 OSD Controls.....	21
2.3 Main Menu.....	22

## Chapter 3 Installation

3.1 Windows 7 Universal Driver Installation for PenMount 6000 Series.....	25
3.2 Software Functions.....	33

## Appendix A: Board Dimensions 51

Board Dimensions.....	51
-----------------------	----

## Appendix B: Panel Mounting and VESA Mounting 52

## Figures

Figure 1.1: Dimensions of ViTAM-110P/R/G/(H).....	12
Figure 1.2: Dimensions of ViTAM-112P/R/G/(H).....	12
Figure 1.3: Dimensions of ViTAM-115P/R/G/(H).....	13
Figure 1.4: Dimensions of ViTAM-116P/R/G/(H).....	13
Figure 1.5: Dimensions of ViTAM-117P/R/G/(H).....	14
Figure 1.6: Dimensions of ViTAM-119P/R/G/(H).....	14

Figure 1.7: Dimensions of ViTAM-121P/R/G/(H).....	15
Figure 1.8: Dimensions of ViTAM-124P/G/(H).....	15
Figure 1.9: Front View and Touch on/off Button of ViTAM-1XX Series.....	16
Figure 1.10: Rear View of ViTAM-110P/R/G/(H).....	17
Figure 1.11: Rear View of ViTAM-112P/R/G(H).....	17
Figure 1.12: Rear View of ViTAM-115P/R/G/(H).....	17
Figure 1.13: Rear View of ViTAM-116P/R/G/(H).....	18
Figure 1.14: Rear View of ViTAM-117P/R/G/(H).....	18
Figure 1.15: Rear View of ViTAM-119P/R/G/(H).....	18
Figure 1.16: Rear View of ViTAM-121P/R/G/(H).....	19
Figure 1.17: Rear View of ViTAM-124P/G/(H).....	19
Figure A: Dimensions of TB-6802.....	51
Figure B: Yoke Mounting of ViTAM-1XX Series.....	52
Figure C: VESA Mounting of ViTAM-1XX Series.....	52

# Chapter 1 Getting Started

## 1.1 Features

- 10.1"/12.1"/15"/15.6"/17"/19"/21.5"/23.8" New Gen. stainless steel display
- True flat front bezel design and grade 304 stainless steel enclosure (grade 316 for option)
- IP66/IP69K rated with M12 connectors
- Support resistive touch, projected capacitive touch, and glass
- Touch on/off button on the side edge for hygienic cleaning
- Support ergonomic versatile mounting: Yoke mounting / space-saving VESA mounting

## 1.2 Specifications

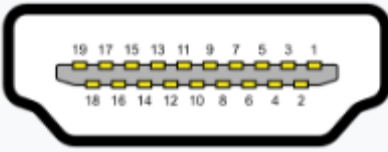
ViTAM-1XX Series																												
<b>I/O port – Standard m12 I/O Connector on the Rear Side with waterproof</b>																												
VGA	1 x M12 for VGA by 12 pin <table border="1" style="margin-left: 20px;"> <thead> <tr> <th></th> <th>Pin Define</th> </tr> </thead> <tbody> <tr><td>1</td><td>R</td></tr> <tr><td>2</td><td>G</td></tr> <tr><td>3</td><td>B</td></tr> <tr><td>4</td><td>DDATA</td></tr> <tr><td>5</td><td>HSYNC</td></tr> <tr><td>6</td><td>GND</td></tr> <tr><td>7</td><td>VSYNC</td></tr> <tr><td>8</td><td>DCLK</td></tr> <tr><td>9</td><td>VCC</td></tr> <tr><td>10</td><td>GND</td></tr> <tr><td>11</td><td>GND</td></tr> <tr><td>12</td><td>GND</td></tr> </tbody> </table>		Pin Define	1	R	2	G	3	B	4	DDATA	5	HSYNC	6	GND	7	VSYNC	8	DCLK	9	VCC	10	GND	11	GND	12	GND	 <p style="text-align: center;"><b>Pin Assignments Front View</b></p>
	Pin Define																											
1	R																											
2	G																											
3	B																											
4	DDATA																											
5	HSYNC																											
6	GND																											
7	VSYNC																											
8	DCLK																											
9	VCC																											
10	GND																											
11	GND																											
12	GND																											
HDMI	1 x W.F. HDMI with waterproof cap <table border="1" style="margin-left: 20px;"> <thead> <tr> <th></th> <th>Type A (Receptacle) HDMI</th> </tr> </thead> <tbody> <tr> <td>1</td> <td>TMDS Data2+</td> </tr> </tbody> </table>		Type A (Receptacle) HDMI	1	TMDS Data2+																							
	Type A (Receptacle) HDMI																											
1	TMDS Data2+																											

	<table border="1"> <tr><td>2</td><td>TMDS Data2 Shield</td></tr> <tr><td>3</td><td>TMDS Data2-</td></tr> <tr><td>4</td><td>TMDS Data1+</td></tr> <tr><td>5</td><td>TMDS Data1 Shield</td></tr> <tr><td>6</td><td>TMDS Data1-</td></tr> <tr><td>7</td><td>TMDS Data0+</td></tr> <tr><td>8</td><td>TMDS Data0 Shield</td></tr> <tr><td>9</td><td>TMDS Data0-</td></tr> <tr><td>10</td><td>TMDS Clock+</td></tr> <tr><td>11</td><td>TMDS Clock Shield</td></tr> <tr><td>12</td><td>TMDS Clock-</td></tr> <tr><td>13</td><td>CEC</td></tr> <tr><td>14</td><td>Reserved (N.C. on device)</td></tr> <tr><td>15</td><td>SCL(I<sup>2</sup>C serial clock for DDC)</td></tr> <tr><td>16</td><td>SDA(I<sup>2</sup>C serial data for DDC)</td></tr> <tr><td>17</td><td>DDC/CEC Ground</td></tr> <tr><td>18</td><td>+5 V Power</td></tr> <tr><td>19</td><td>Hot Plug Detect</td></tr> </table>	2	TMDS Data2 Shield	3	TMDS Data2-	4	TMDS Data1+	5	TMDS Data1 Shield	6	TMDS Data1-	7	TMDS Data0+	8	TMDS Data0 Shield	9	TMDS Data0-	10	TMDS Clock+	11	TMDS Clock Shield	12	TMDS Clock-	13	CEC	14	Reserved (N.C. on device)	15	SCL(I <sup>2</sup> C serial clock for DDC)	16	SDA(I <sup>2</sup> C serial data for DDC)	17	DDC/CEC Ground	18	+5 V Power	19	Hot Plug Detect	
2	TMDS Data2 Shield																																					
3	TMDS Data2-																																					
4	TMDS Data1+																																					
5	TMDS Data1 Shield																																					
6	TMDS Data1-																																					
7	TMDS Data0+																																					
8	TMDS Data0 Shield																																					
9	TMDS Data0-																																					
10	TMDS Clock+																																					
11	TMDS Clock Shield																																					
12	TMDS Clock-																																					
13	CEC																																					
14	Reserved (N.C. on device)																																					
15	SCL(I <sup>2</sup> C serial clock for DDC)																																					
16	SDA(I <sup>2</sup> C serial data for DDC)																																					
17	DDC/CEC Ground																																					
18	+5 V Power																																					
19	Hot Plug Detect																																					
Touch	<p>1 x M12 for TOUCH USB 2.0</p> <table border="1"> <thead> <tr> <th>CN1</th> <th>Pin Define</th> </tr> </thead> <tbody> <tr><td>1</td><td>USB 5V</td></tr> <tr><td>7</td><td>D-</td></tr> <tr><td>6</td><td>D+</td></tr> <tr><td>5</td><td>GND</td></tr> <tr><td>4</td><td>NC</td></tr> <tr><td>3</td><td>NC</td></tr> <tr><td>8</td><td>NC</td></tr> <tr><td>2</td><td>NC</td></tr> </tbody> </table>	CN1	Pin Define	1	USB 5V	7	D-	6	D+	5	GND	4	NC	3	NC	8	NC	2	NC	 <p>Pin Assignments Front View 正視圖</p>																		
CN1	Pin Define																																					
1	USB 5V																																					
7	D-																																					
6	D+																																					
5	GND																																					
4	NC																																					
3	NC																																					
8	NC																																					
2	NC																																					



Power	1 x DC power input (9~36V) by M12 connector								
	<table border="1"> <thead> <tr> <th></th> <th>Pin Define</th> </tr> </thead> <tbody> <tr> <td>1</td> <td>NC</td> </tr> <tr> <td>3</td> <td>VCC</td> </tr> <tr> <td>4</td> <td>GND</td> </tr> </tbody> </table>			Pin Define	1	NC	3	VCC	4
	Pin Define								
1	NC								
3	VCC								
4	GND								
Others	1 x Touch on/off button on the side								
OSD Control Membrane	OSD on the rear side								
Speaker	1 x 2W IP65 speaker (optional)								
<b>Touch Screen</b>									
Type	Resistive touch window (for R model) <b>(not available for ViTAM-124)</b> Projected capacitive touch screen (for P model)								
Interface	USB								
Light Transmission	Resistive touch window: over 80% Projected capacitive touch screen: over 90%								
<b>Glass Type (option)</b>									
Type	AR								
Light Transmission	Over 90%								
<b>Power</b>									
Power Input	DC 9~36V								
<b>Mechanical</b>									
Construction	304 Stainless steel enclosure (default) 316 Stainless steel enclosure (optional)								
Construction	Stainless steel enclosure								
IP Rating	IP66/IP69K								
<b>Environmental</b>									
Operating temperature	0~50°C / -20~60°C for option <b>(for 10.1"~15" model)</b> 0~50°C <b>(for 15.6", 17", 19", 23.8" model)</b> 0~40°C <b>(for 21.5" High Brightness model)</b>								
Storage temperature	-30~70°C								
Storage humidity	10 to 90% @ 40°C, non- condensing								
Certification	CE / FCC Class A								

- **Power Consumption and Mechanical Specifications**

	<b>ViTAM-110</b> <b>P/R/G/(H)</b>	<b>ViTAM-112</b> <b>P/R/G/(H)</b>	<b>ViTAM-115</b> <b>P/R/G/(H)</b>	<b>ViTAM-116</b> <b>P/R/G/(H)</b>
<b>Power Consumption</b>				
Power Consumption	MAX: 6.2W (110R) MAX: 11W (110P)	MAX: 8.9W (112R) MAX: TBD (112P)	MAX: TBD (115R) MAX: 9.3W (115P)	MAX: TBD (116R) MAX: 12.5W (116P)
<b>Mechanical</b>				
Mounting	VESA mount 75 x 75, Yoke mount			
Dimensions(mm)	300 x 220 x 53	335 x 265 x 53	399 x 324 x 53	440 x 290 x 55
Net Weight	3.5 Kg	4.5 Kg	6.5 Kg	6.5 Kg

	<b>ViTAM-117</b> <b>P/R/G/(H)</b>	<b>ViTAM-119</b> <b>P/R/G/(H)</b>	<b>ViTAM-121</b> <b>P/R/G/(H)</b>	<b>ViTAM-124</b> <b>P/G/(H)</b>
<b>Power Consumption</b>				
Power Consumption	MAX: TBD (117R) MAX: 19.2W (117P)	MAX: TBD (119R) MAX: 18.6W (119P)	MAX: 11W (121R) MAX: TBD (121P)	MAX: 26.4W (124P)
<b>Mechanical</b>				
Mounting	VESA mount 75 x 75, Yoke mount	VESA mount 100 x 100, Yoke mount		VESA mount 200 x 100, Yoke mount
Dimensions(mm)	432 x 358 x 55.3	470 x 388.6 x 60	571 x 362 x 55	656 x 423 x 53
Net Weight	7.5 Kg	8.8 Kg	9.4 Kg	12 Kg

- **Standard LCD**

	<b>ViTAM-110P/ ViTAM-110R/ ViTAM-110G</b>	<b>ViTAM-112P/ ViTAM-112R/ ViTAM/112G</b>	<b>ViTAM-115P/ ViTAM-115R/ ViTAM-115G</b>	<b>ViTAM-116P/ ViTAM-116R/ ViTAM-116G</b>
<b>Display</b>				
Display Type	10.1" TFT LCD	12.1" TFT LCD	15" TFT LCD	15.6" TFT LCD
Max. Resolution	1280 x 800	800 x 600/ 1024 x 768 (option)	1024 x 768	1366 x 768
Max. Colors	16.7M	262K/16.2M (option)	262K	16.7M
Contrast Ratio	800: 1	800: 1/	800: 1	500: 1

		700: 1 (option)		
Luminance(cd/m <sup>2</sup> )	350	450 / 500 (option)	420	300
Viewing Angle	170(H) / 170(V)	160(H) / 150(V) 160(H) / 140(V) (option)	160(H) / 160(V)	160(H) / 160(V)
Backlight Lifetime	15,000 hrs	50,000hrs/ 30,000 hrs (option)	30,000 hrs	50,000 hrs
Option	Optical bonding			

	<b>ViTAM-117P/ ViTAM-117R/ ViTAM-117G</b>	<b>ViTAM-119P/ ViTAM-119R/ ViTAM-119G</b>	<b>ViTAM-121P/ ViTAM-121R/ ViTAM-124G</b>	<b>ViTAM-124P/ ViTAM-124G</b>
<b>Dipslay</b>				
Display Type	17" TFT LCD	19" TFT LCD	21.5" TFT LCD	23.8" TFT LCD
Max. Resolution	1280 x 1024	1280 x 1024	1920 x 1080	1920 x 1080
Max. Colors	16.7M	16.7M	16.7M	16.7M
Contrast Ratio	1000: 1	1000: 1	3000: 1	3000: 1
Luminance(cd/m <sup>2</sup> )	350	350	300	250
Viewing Angle	170(H) / 170(V)	170(H) / 165(V)	178(H) / 178(V)	178(H) / 178(V)
Backlight Lifetime	50,000 hrs	50,000 hrs	50,000 hrs	30,000 hrs
Option	Optical bonding			

- **High Brightness LCD (Option)**

	<b>ViTAM-110PH/ ViTAM-110RH/ ViTAM-110GH</b>	<b>ViTAM-112PH/ ViTAM-112RH/ ViTAM-112GH</b>	<b>ViTAM-115PH/ ViTAM-115RH/ ViTAM-115GH</b>	<b>ViTAM-116PH/ ViTAM-116RH/ ViTAM-116GH</b>
<b>Dipslay</b>				
Display Type	10.1" TFT LCD	12.1" TFT LCD	15" TFT LCD	15.6" TFT LCD
Max. Resolution	1280 x 800	800 x 600/ 1024 x 768 (option)	1024 x 768	1366 x 768
Max. Colors	16.7M	262K/16.2M (option)	262k	16.7M
Contrast Ratio	800: 1	700: 1	800: 1	500: 1

Luminance(cd/m <sup>2</sup> )	1000	1000	1000	1000
Viewing Angle	170(H) / 170(V)	178(H) / 178(V) 160(H) / 140(V) (option)	160(H) / 150(V)	160(H) / 160(V)
Backlight Lifetime	50,000hrs	50,000hrs	30,000hrs	50,000hrs
Option	Optical bonding			

	<b>ViTAM-117PH/ ViTAM-117RH/ ViTAM-117GH</b>	<b>ViTAM-119PH/ ViTAM-119RH/ ViTAM-119GH</b>	<b>ViTAM-121PH/ ViTAM-121RH/ ViTAM-121GH</b>	<b>ViTAM-124PH/ ViTAM-124GH</b>
<b>Display</b>				
Display Type	17" TFT LCD	19" TFT LCD	21.5" TFT LCD	23.8" TFT LCD
Max. Resolution	1280 x 1024	1280 x 1024	1920 x 1080	1920 x 1080
Max. Colors	16.7M	16.7M	16.7M	16.7M
Contrast Ratio	1000: 1	1000: 1	3000: 1	5000: 1
Luminance(cd/m <sup>2</sup> )	1000	1000	1000	1000
Viewing Angle	170(H) / 160(V)	170(H) / 160(V)	178(H) / 178(V)	178(H) / 178(V)
Backlight Lifetime	50,000hrs	50,000hrs	50,000hrs	30,000hrs
Option	Optical bonding			

### 1.3 Dimensions

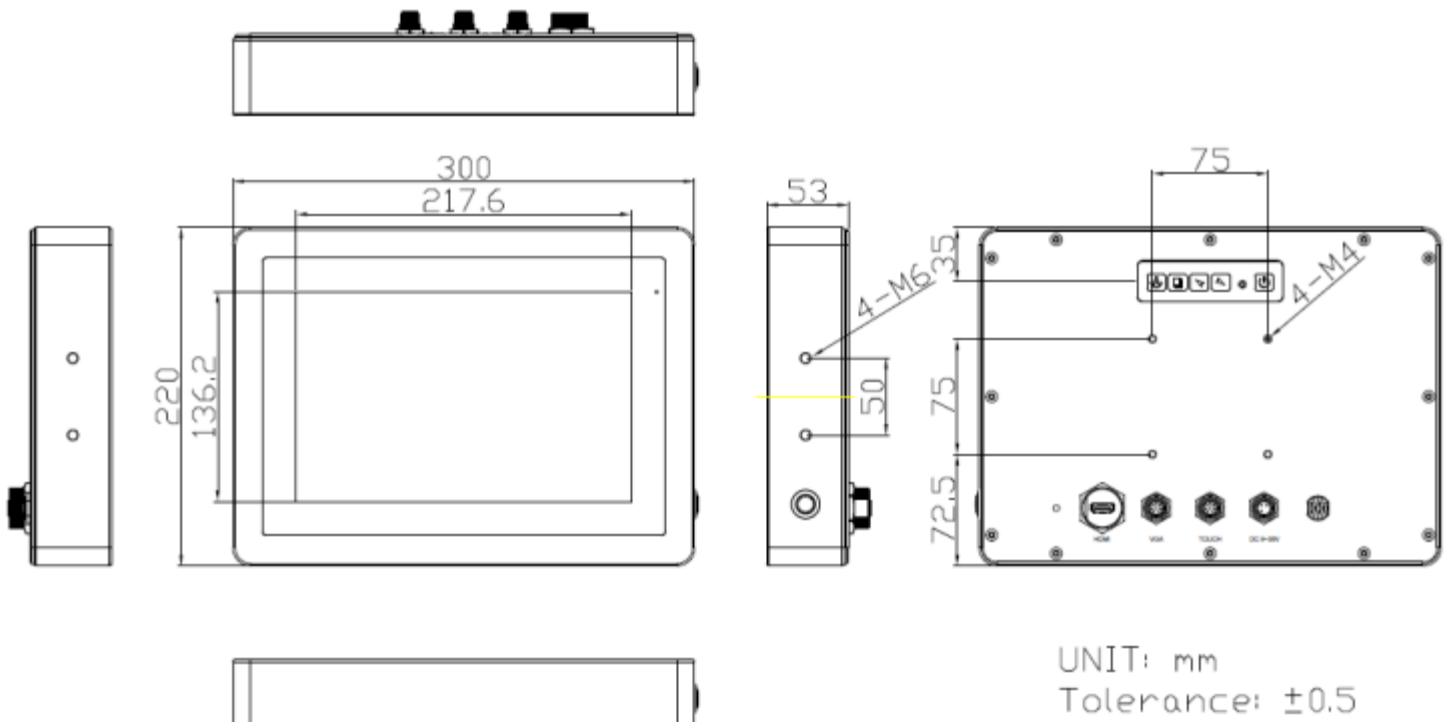

Figure 1.1: Dimensions of ViTAM-110P/R/G/(H)

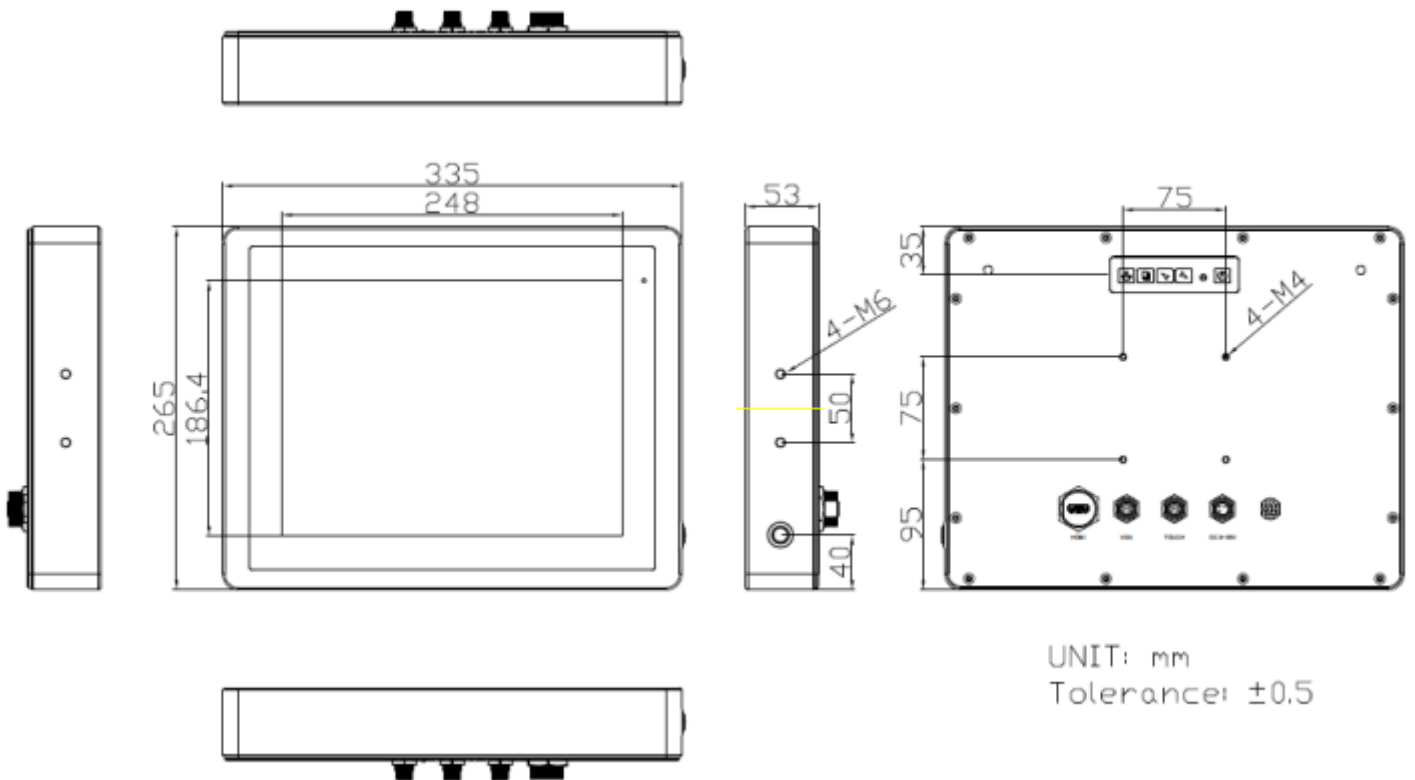
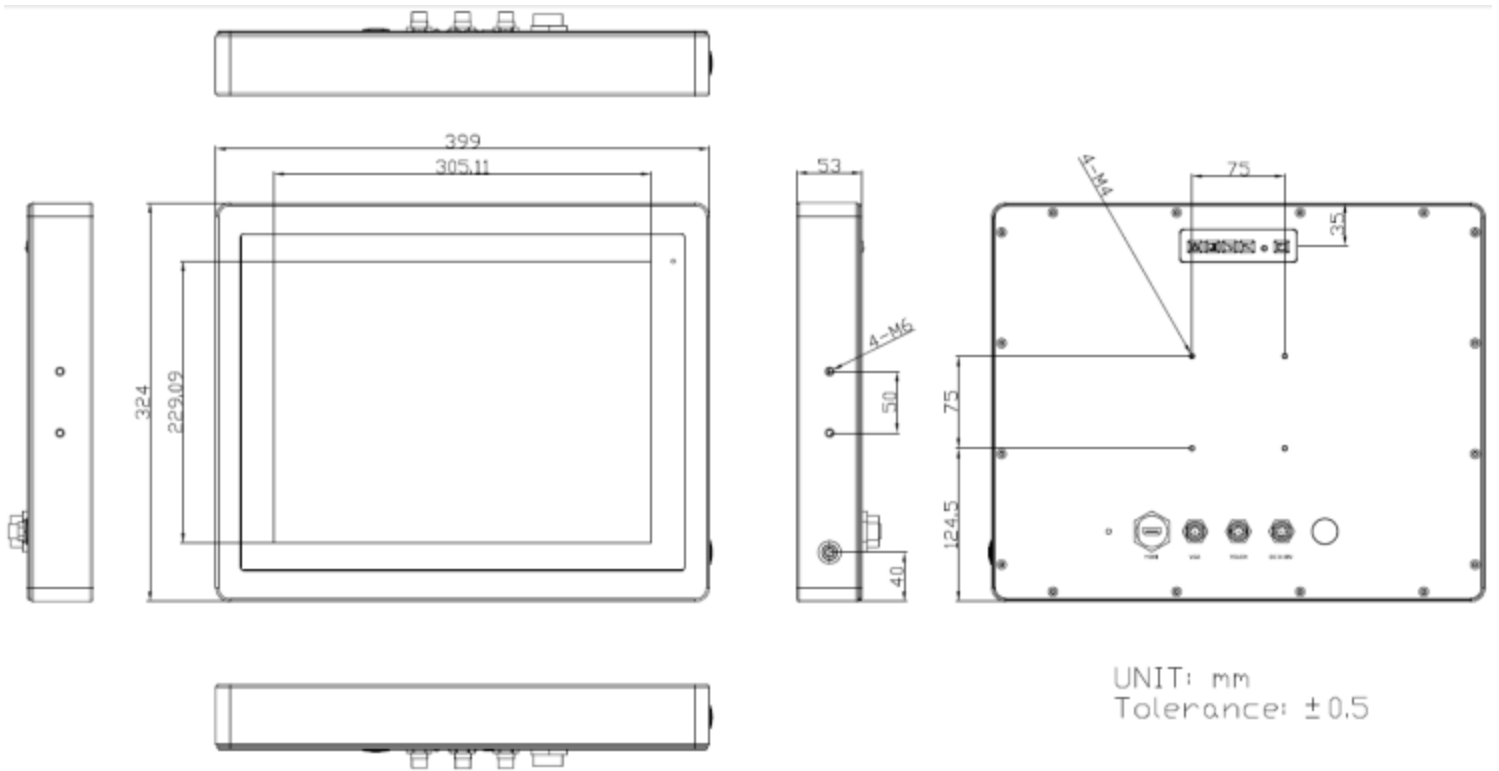
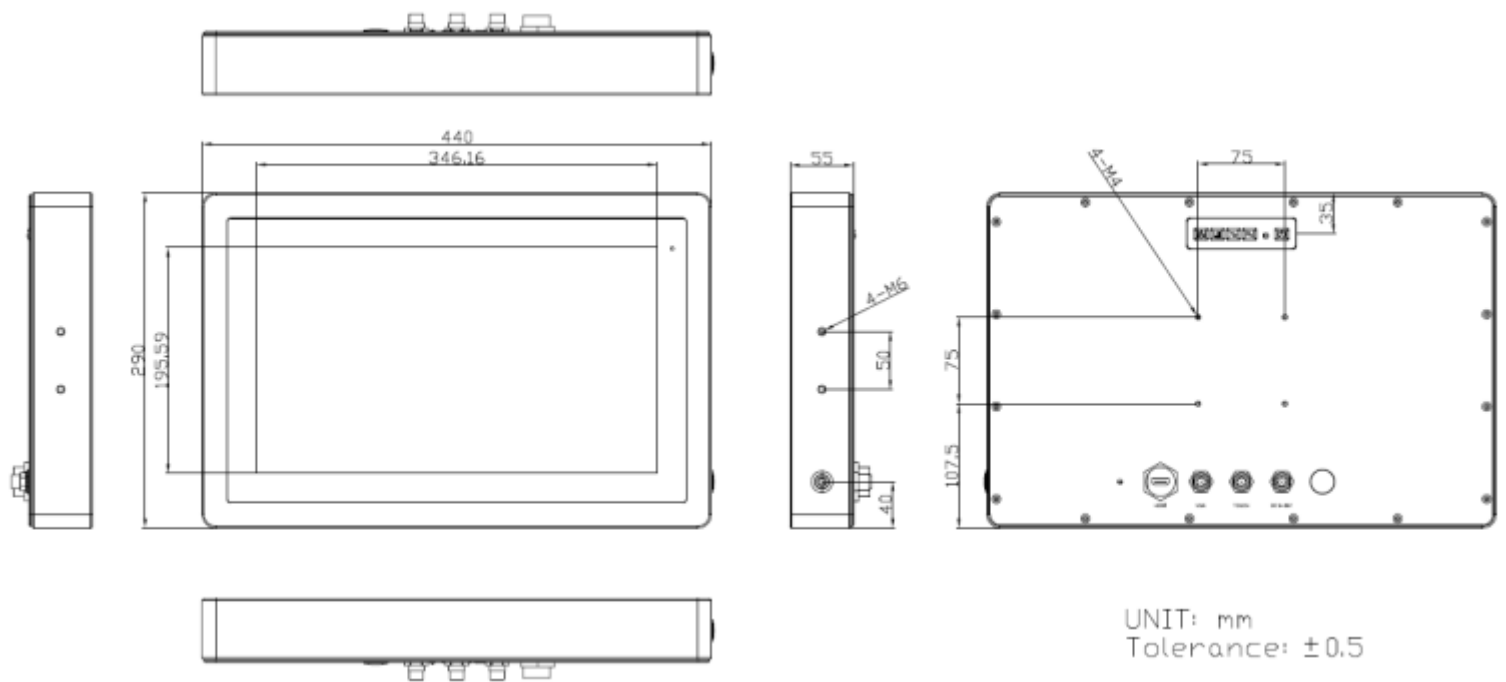

Figure 1.2: Dimensions of ViTAM-112P/R/G/(H)



**Figure 1.3: Dimensions of ViTAM-115P/R/G/(H)**



**Figure 1.4: Dimensions of ViTAM-116P/R/G/(H)**

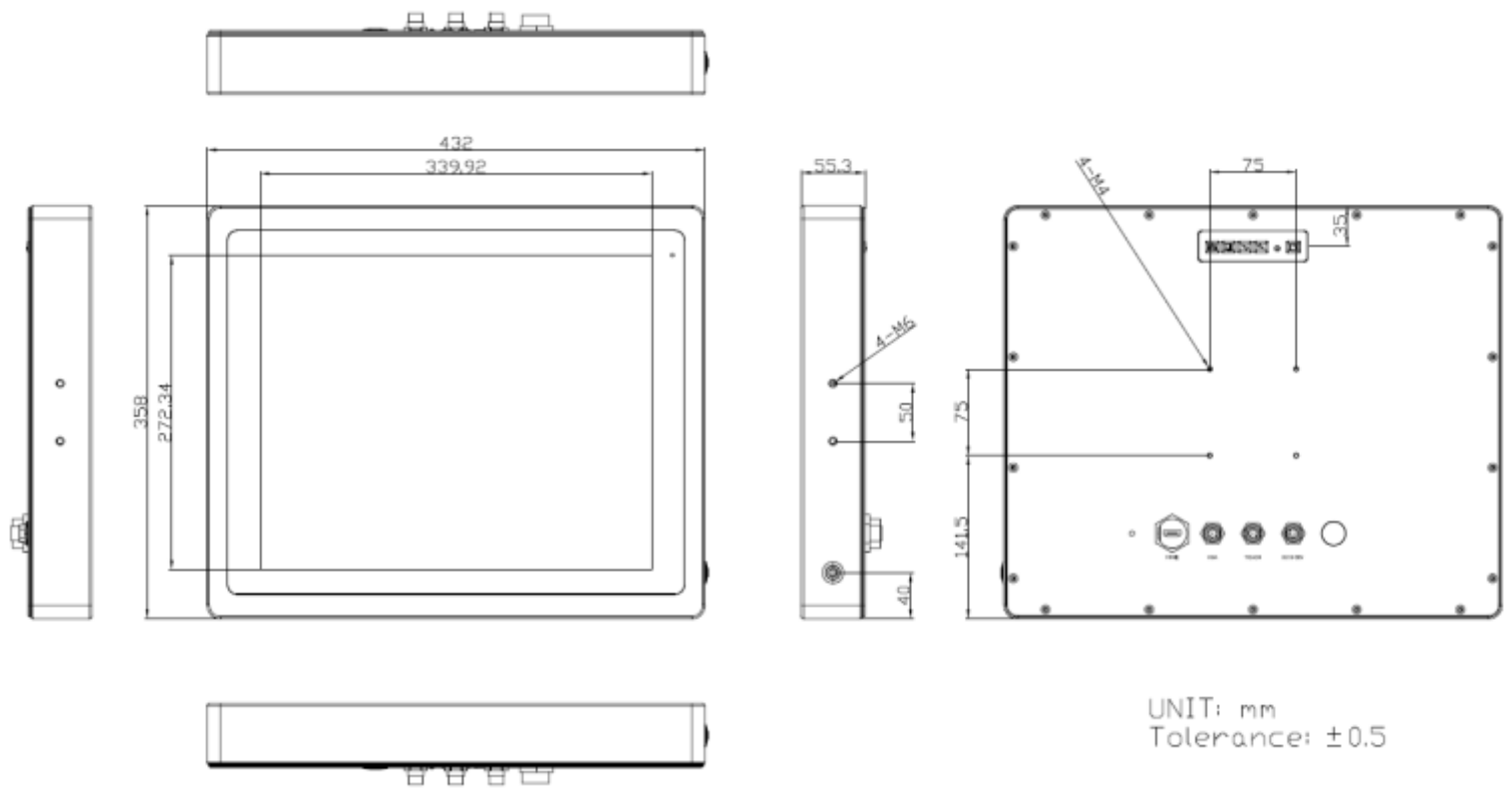

Figure 1.5: Dimensions of ViTAM-117P/R/G/(H)

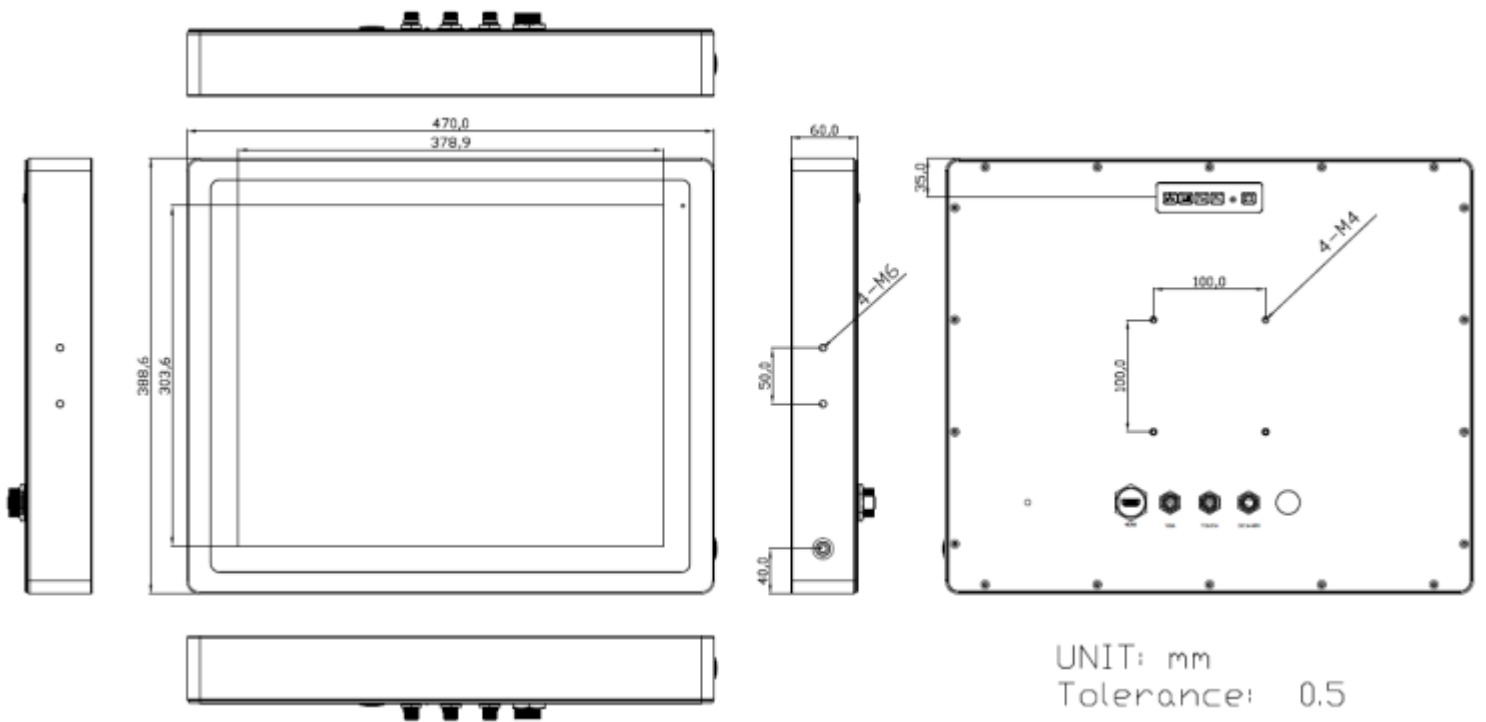

Figure 1.6: Dimensions of ViTAM-119P/R/G/(H)

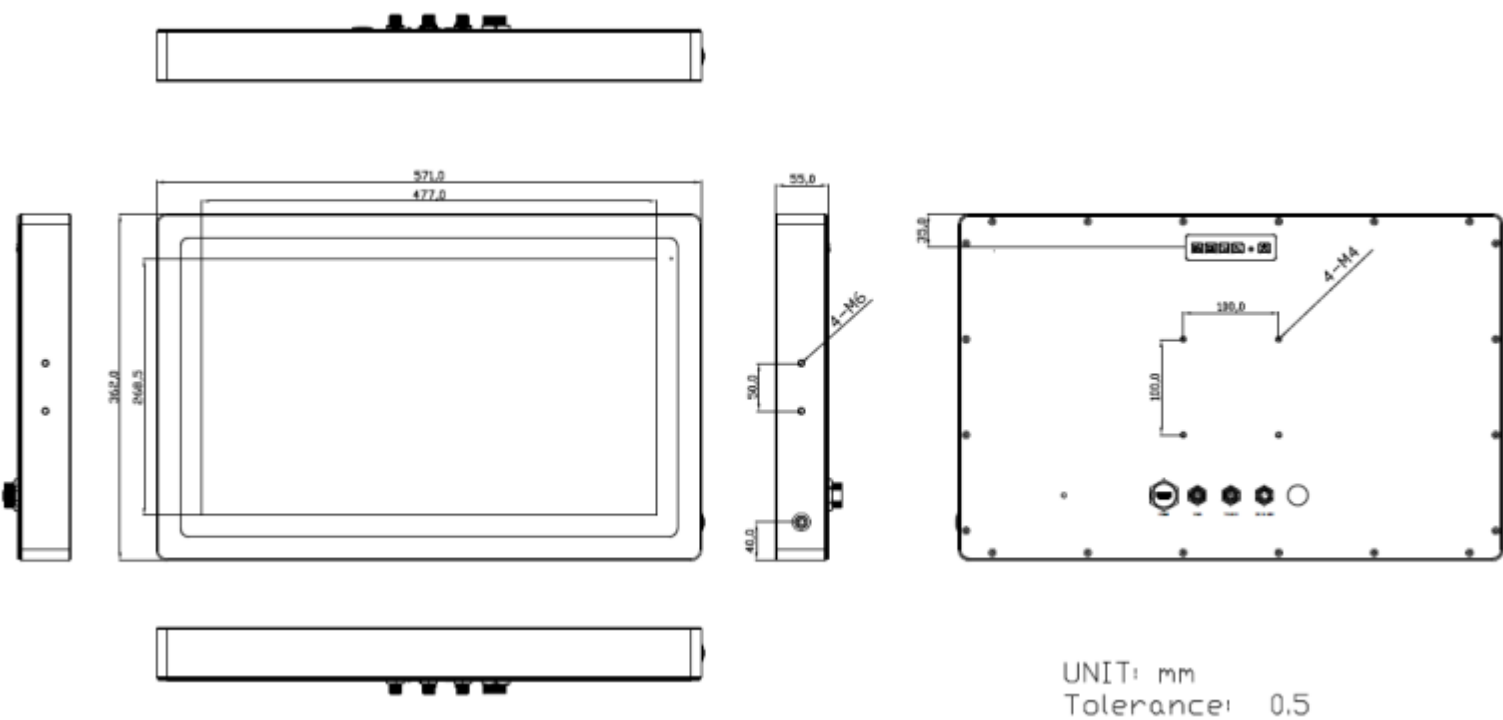

Figure 1.7: Dimensions of ViTAM-121P/R/G/(H)

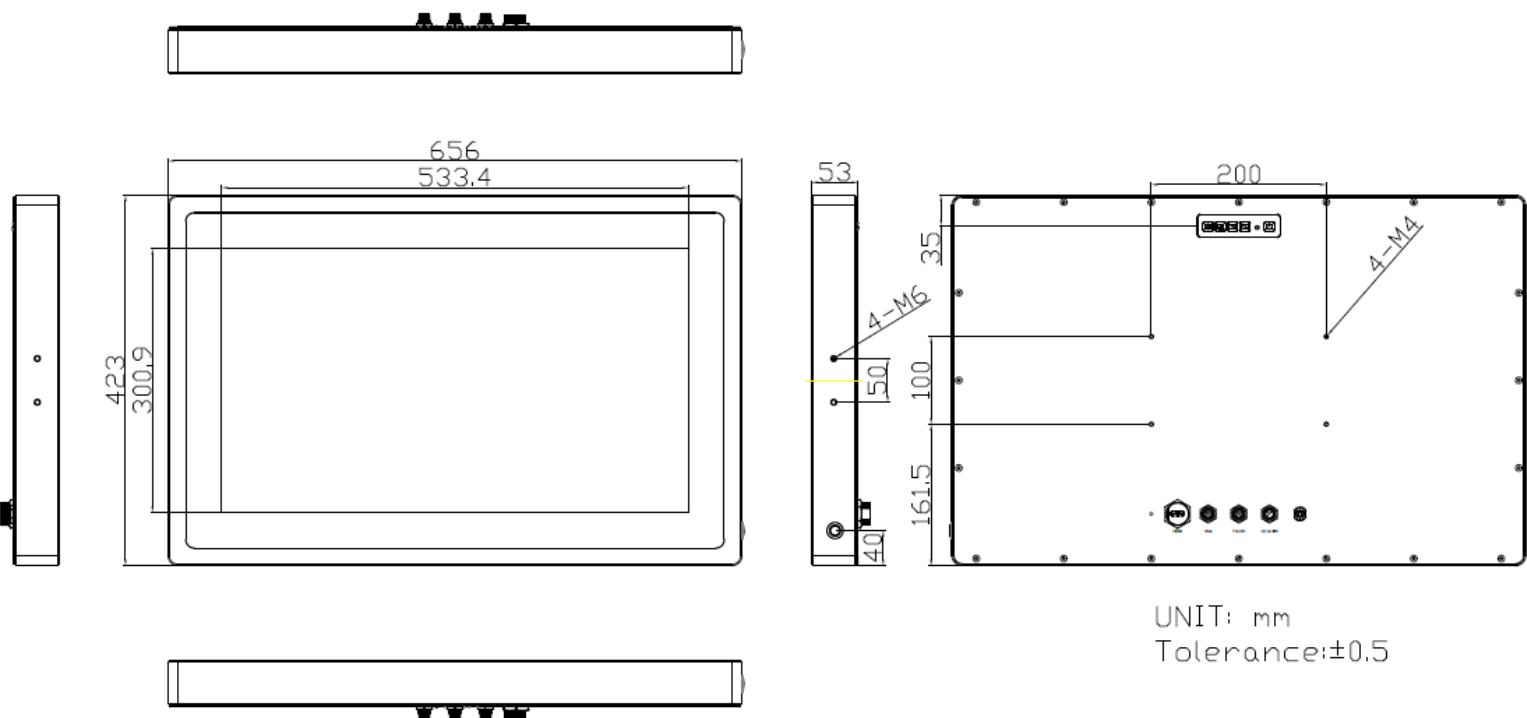
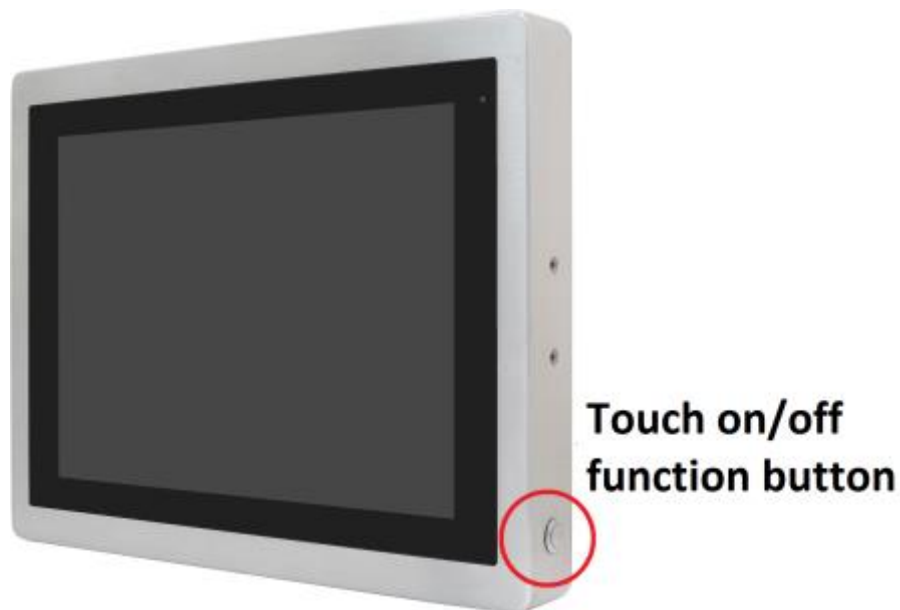

Figure 1.8: Dimensions of ViTAM-124P/G/(H)



## 1.4 Brief Description of ViTAM-1XX Series

ViTAM-1XX series with TB-6802 AD board is an IP66/IP69K rated with M12 connectors new generation stainless steel display, which comes with 10.1", 12.1", 15", 15.6", 17", 19", 21.5", and 23.8" color TFT LCD. ViTAM-1XX series are wide range DC 9~36V power input and true flat front bezel designed with grade 304 stainless steel enclosure (grade 316 is for option). Furthermore, the models support resistive touch, projected capacitive touch, and glass for option, and can be high brightness LCD and optical bonding designed for option. It supports touch on/off button on the side edge for hygienic cleaning and ergonomic versatile mounting: Yoke mounting and space-saving VESA mounting.



**Figure 1.9: Front View and Touch on/off Button of ViTAM-1XX Series**



**Figure 1.10: Rear View of ViTAM-110P/R/G/(H)**



**Figure 1.11: Rear View of ViTAM-112P/R/G/(H)**



**Figure 1.12: Rear View of ViTAM-115P/R/G/(H)**



**Figure 1.13: Rear View of ViTAM-116P/R/G/(H)**



**Figure 1.14: Rear View of ViTAM-117P/R/G/(H)**



**Figure 1.15: Rear View of ViTAM-119P/G/(H)**

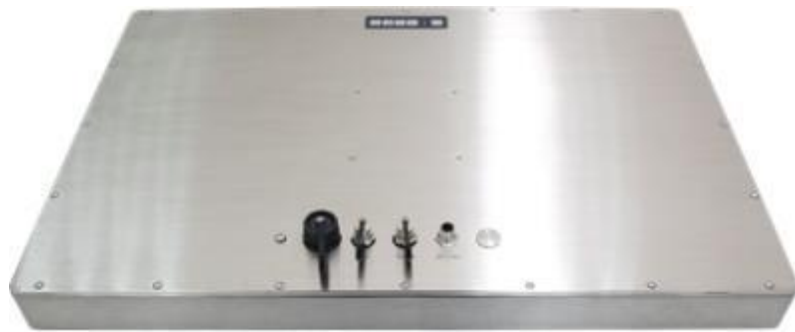
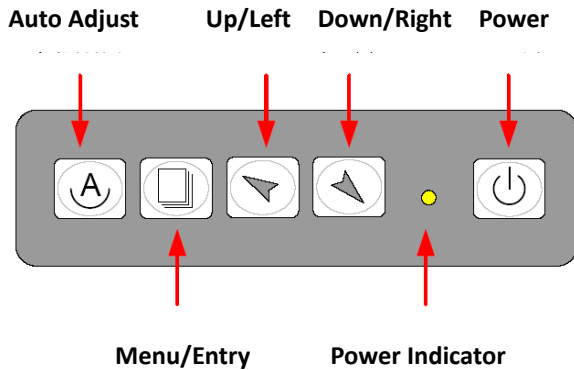



**Figure 1.16: Rear View of ViTAM-121P/G/(H)**



**Figure 1.17: Rear View of ViTAM-124P/G/(H)**

## 2.1 AD Board OSD Functions



 Power switch: To turn ON or OFF the power



 Shift the icon to the right side or shift it up

 Shift the icon to the left side or shift it down



 Menu: To enter OSD menu for related icon and item.

 Auto Button: One-touch auto adjustment





### 1.) Getting into Burn-in Mode

Before setting into a burn-in mode, first disconnect the AC power cord. Then press (don't let them go) the   buttons until the AC power cord is connected and the "RGB" appears on the top left corner of your screen. Now it can be put into the burn-in mode for changing colors.

### 2.) Getting Out of Burn-in Mode









Before getting out of the burn-in mode, please first disconnect the AC power cord. Then press the  button (If not workable, press the  button and don't let them go) until the AC power cord is connected. Please don't let your fingers go until the AC power cord is connected again and the wording of "RGB" appears on the top left corner of your screen, and wait for 3 second. Under the non-signal entry situation, if **Cable Not Connected** is seen, exit is thus successfully made.

### When the Burn-in Mode is Unable to Eradicate...

- 1.) If the “RGB” is still on the top left corner of the screen, press  to enter “Miscellaneous” and choose “Reset”, and then **Yes**, and press . When the screen goes black, disconnect power and repeat the above steps.
- 2.) If the “RGB” is not found, disconnect the AC power cord first. Then press the   buttons (don't let them go) until the AC power cord is connected, and wait for 2 to 3 seconds. When “RGB” appears, repeat the above steps.

## 2.2 OSD Controls

To make any adjustment, select the following:

1. Press  (Menu) to show the OSD menu or disable the OSD menu.
2. Select the icon that you wish to adjust with the (  /  or +/-) key in the menu.
3. Press  (Menu) and then choose the item with the (  /  or +/-) key.
4. Press  (Menu) and then adjust the quality with the (  /  or +/-) key.

## 2.3 Main Menu

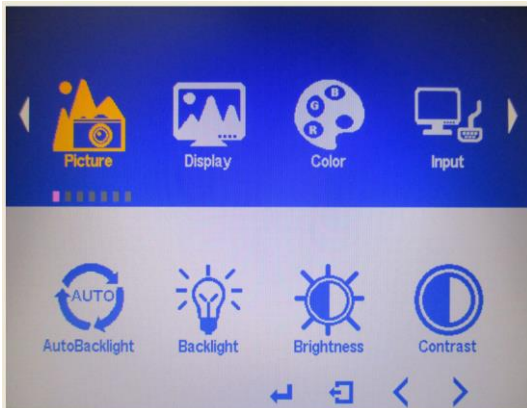

In the **PICTURE**, there are the following items:

- AutoBacklight
- Backlight
- Brightness
- Contrast
- Sharpness
- Exit

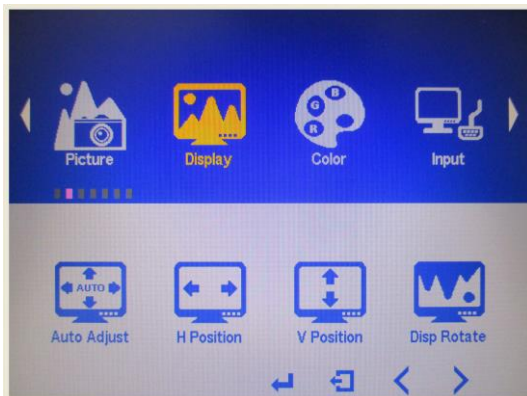
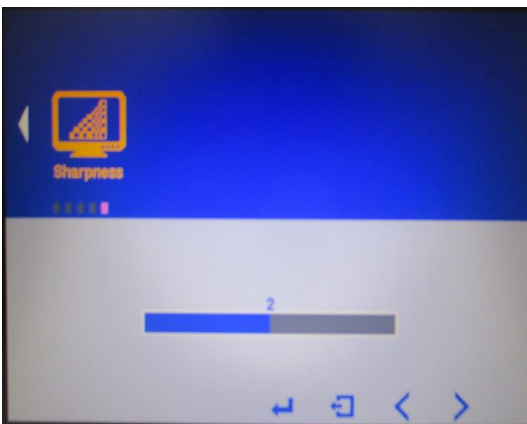

In the **DISPLAY**, there are the following items:

- AutoAdjust
- H Position
- V Position
- Disp Rotate
- Exit

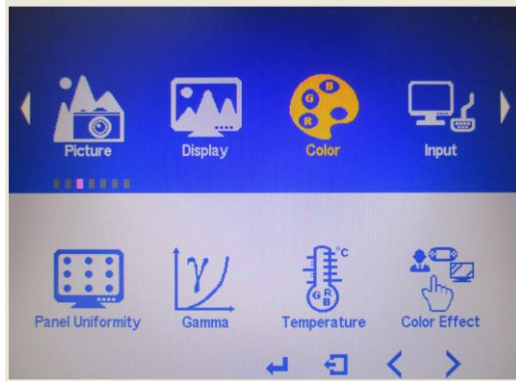

In the **COLOR**, there are the following items:

- Panel Uniformity
- Gamma
- Color Temp
- Color Effect
- Exit

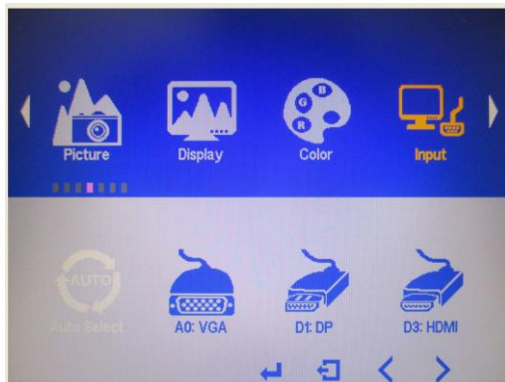

In the **INPUT**, there are the following items:

- A0:VGA
- D1:DP
- D3:HDMI
- Exit

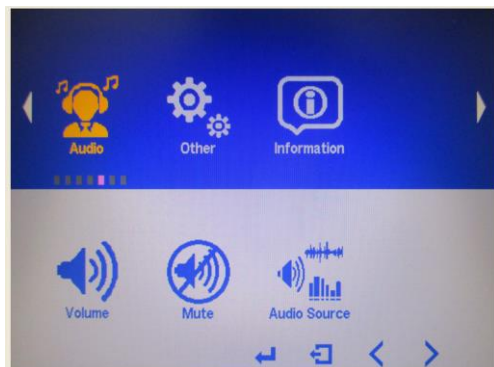

In the **AUDIO**, there are the following items:

- Volume
- Mute
- Audio Source
- Exit



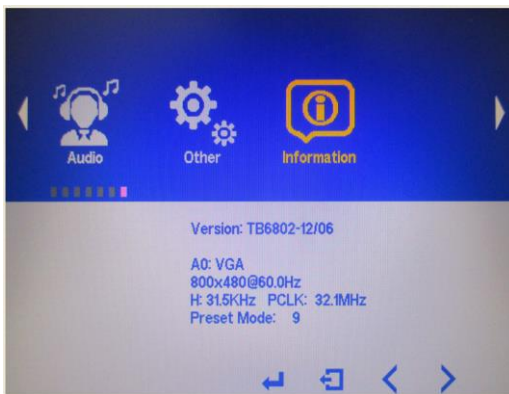
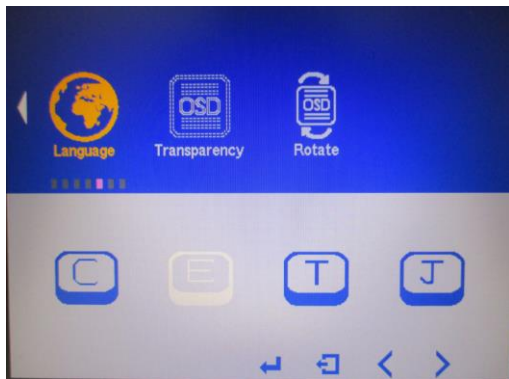
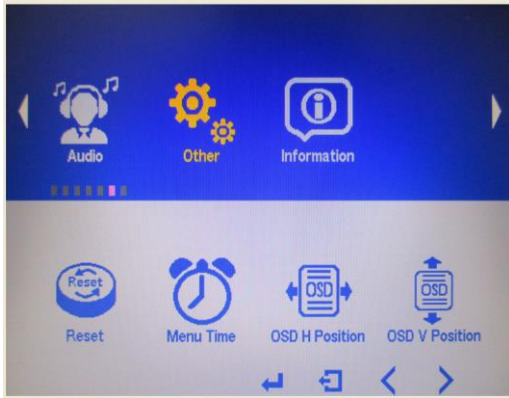

In the **OTHER**, there are the following items:

- Reset
- Menu Time
- OSD H Position
- OSD V Position
- Language
- Transparency
- Rotate
- Exit

**Information** part.

# Chapter 3 Installation

This chapter describes how to install drivers and other software that will allow your touch screen work with different operating systems.

## 3.1 Windows 7 Universal Driver Installation for PenMount 6000 Series

Before installing the Windows 7 driver software, you must have the Windows 7 system installed and running on your computer. You must also have one of the following PenMount 6000 series controller or control boards installed: PM6500, PM6300.

### 3.1.1 Installing Software(Resistive Touch)

If you have an older version of the PenMount Windows 7 driver installed in your system, please remove it first. Follow the steps below to install the PenMount DMC6000 Windows 7 driver.

**Step 1.** Click **Next** to continue.

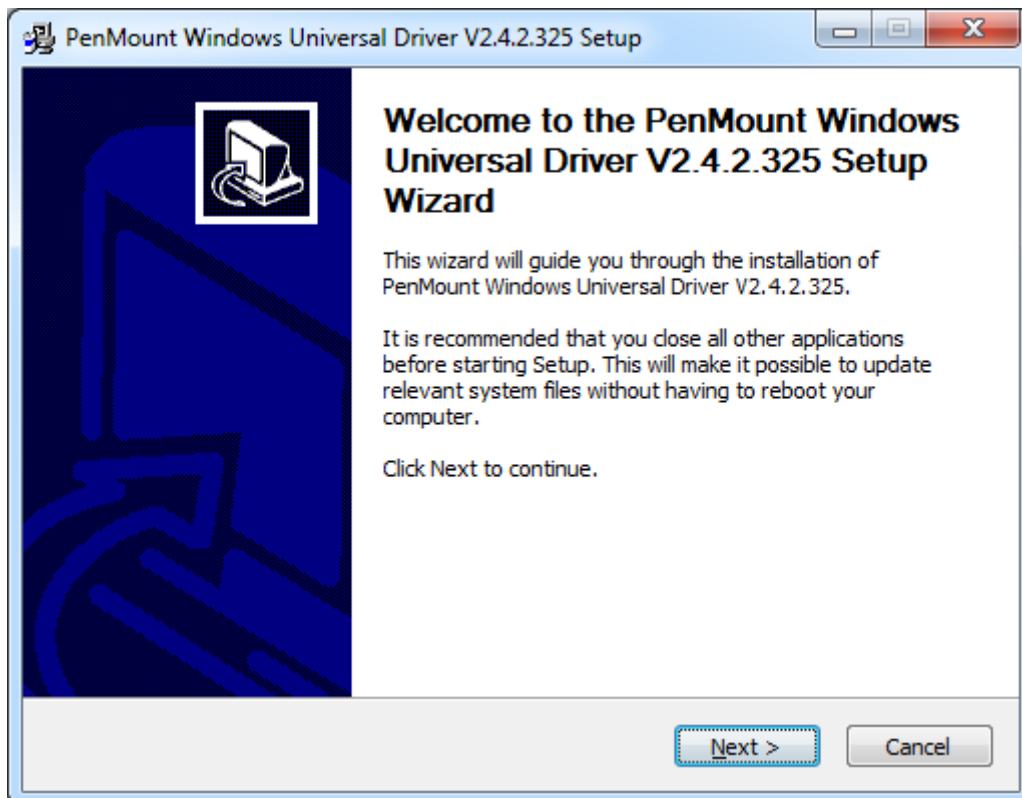

**Step 2.** Read the license agreement. Click **I Agree** to agree the license agreement.

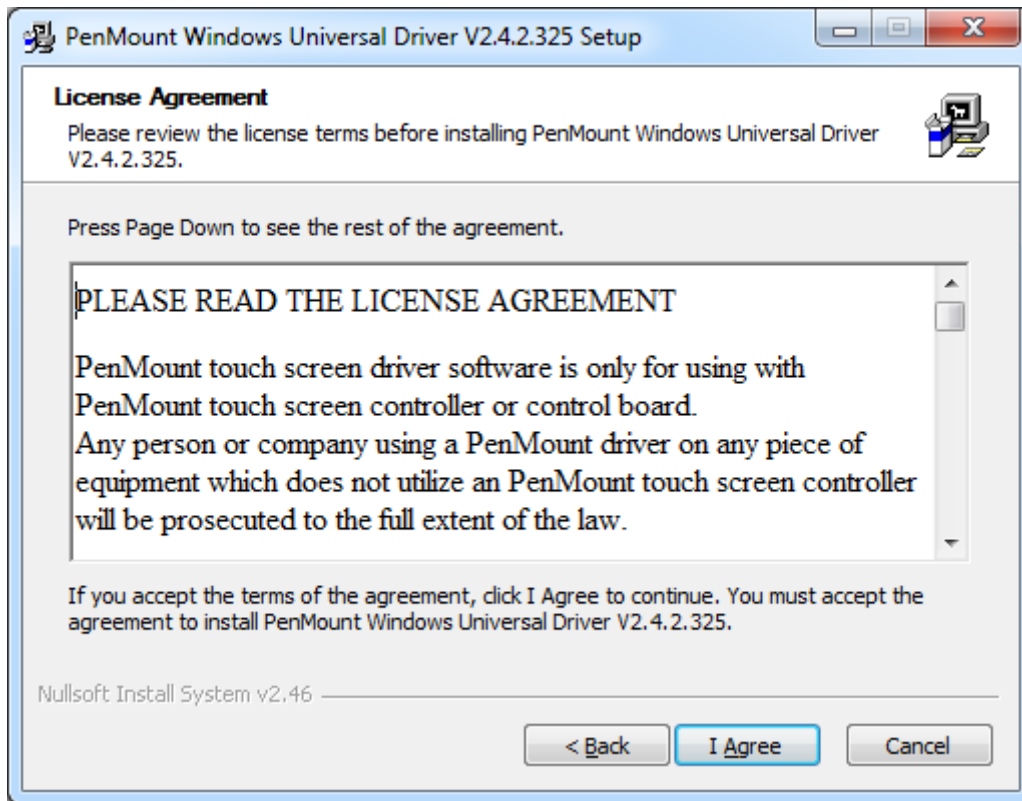

**Step 3.** Choose the folder in which to install PenMount Windows Universal Driver. Click **Install** to start the installation.

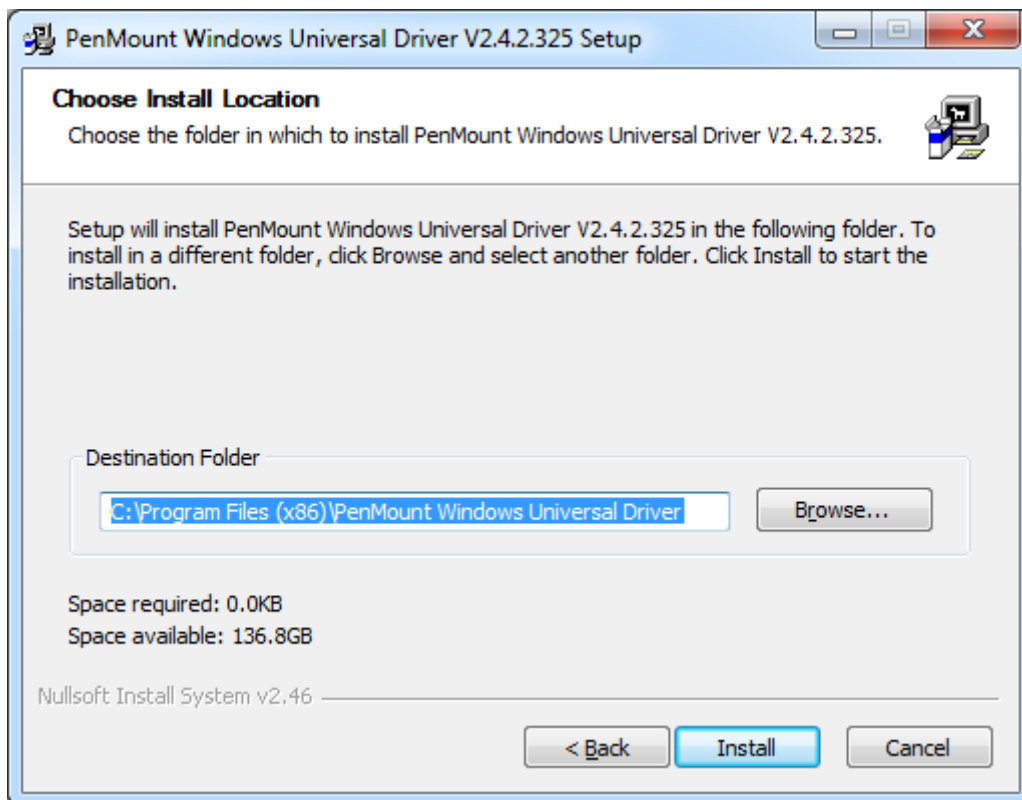

**Step 4.** Click **Yes** to continue.

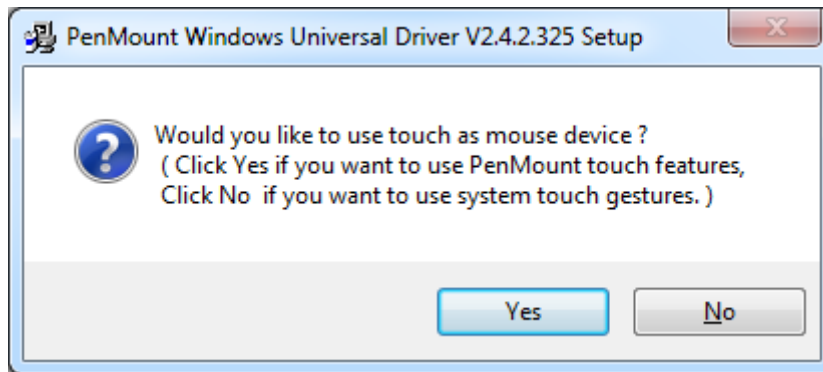

**Step 5.** Click **Finish** to complete installation.

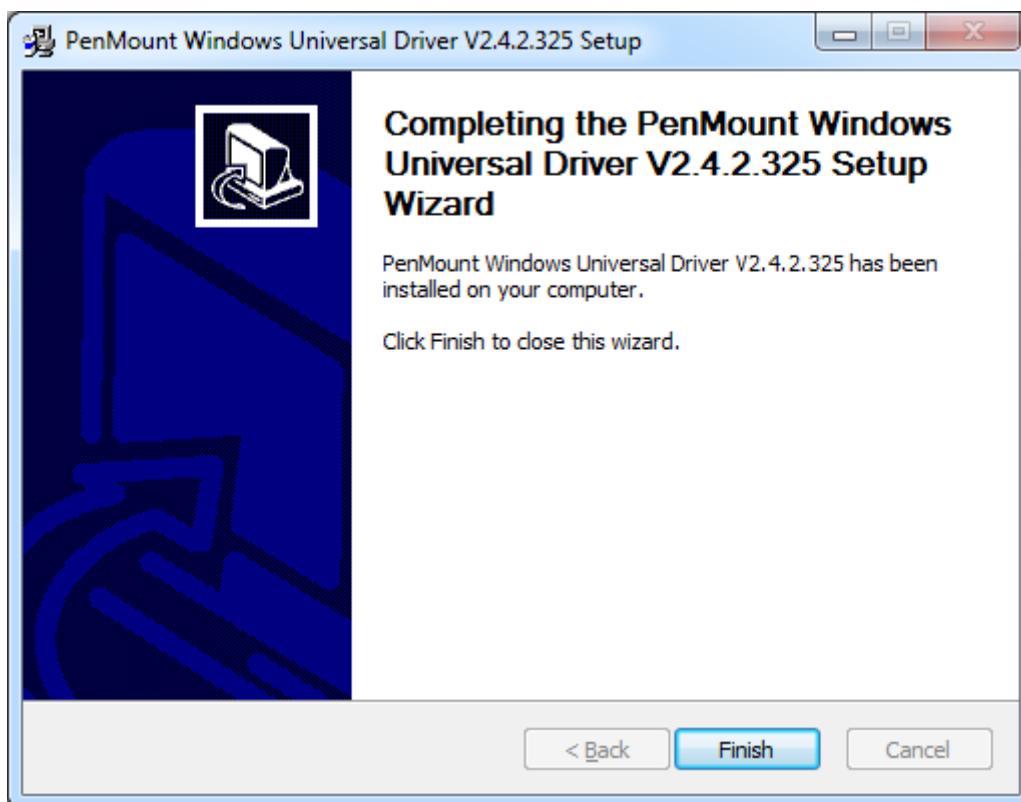

### 3.1.2 Installing Software (Projected Capacitive)

Step 1. Click **Next** to continue.

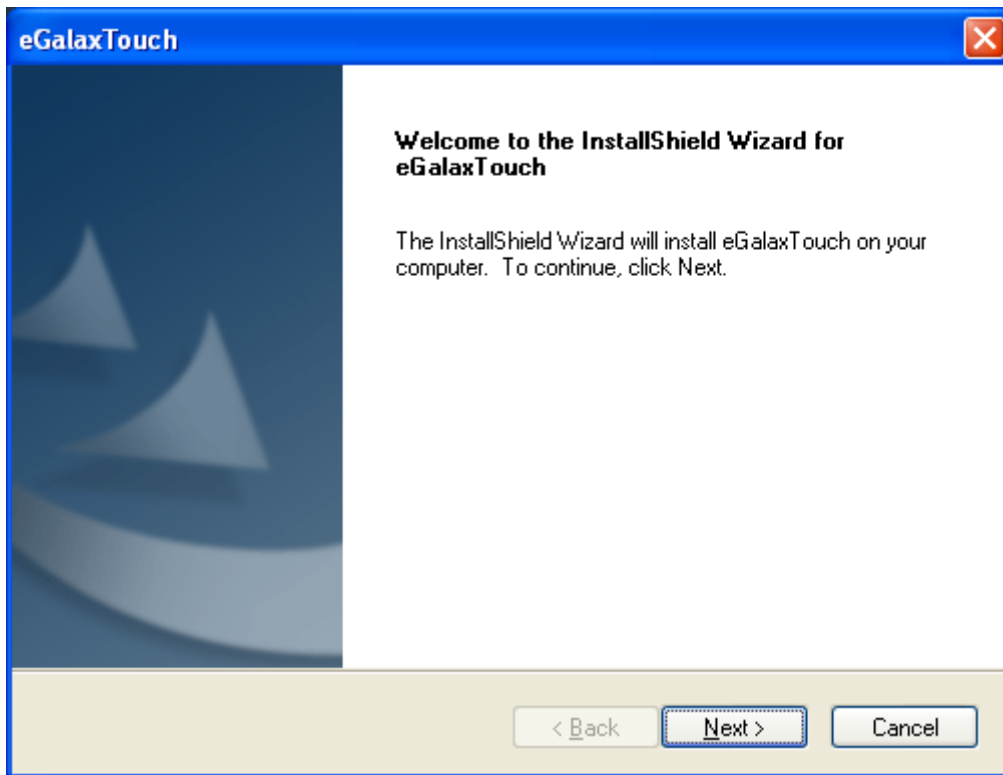

Step 2. Select **I accept the terms of the license agreement**. Click **Next**.

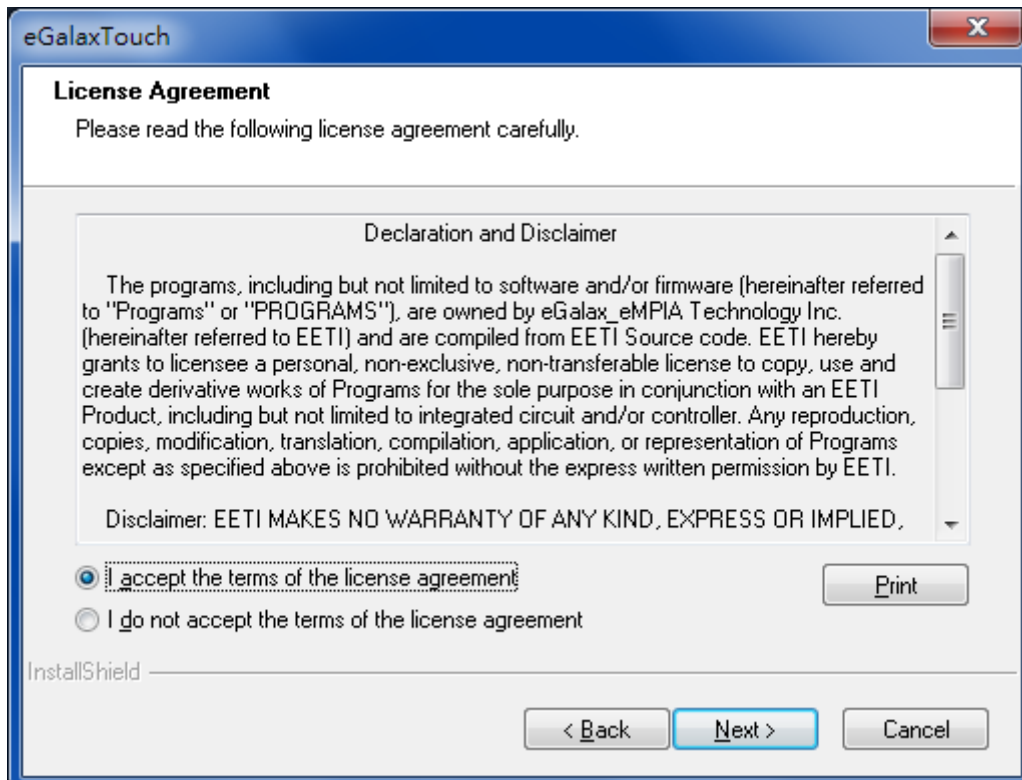

**Step.3.** Click **Next** to continue.

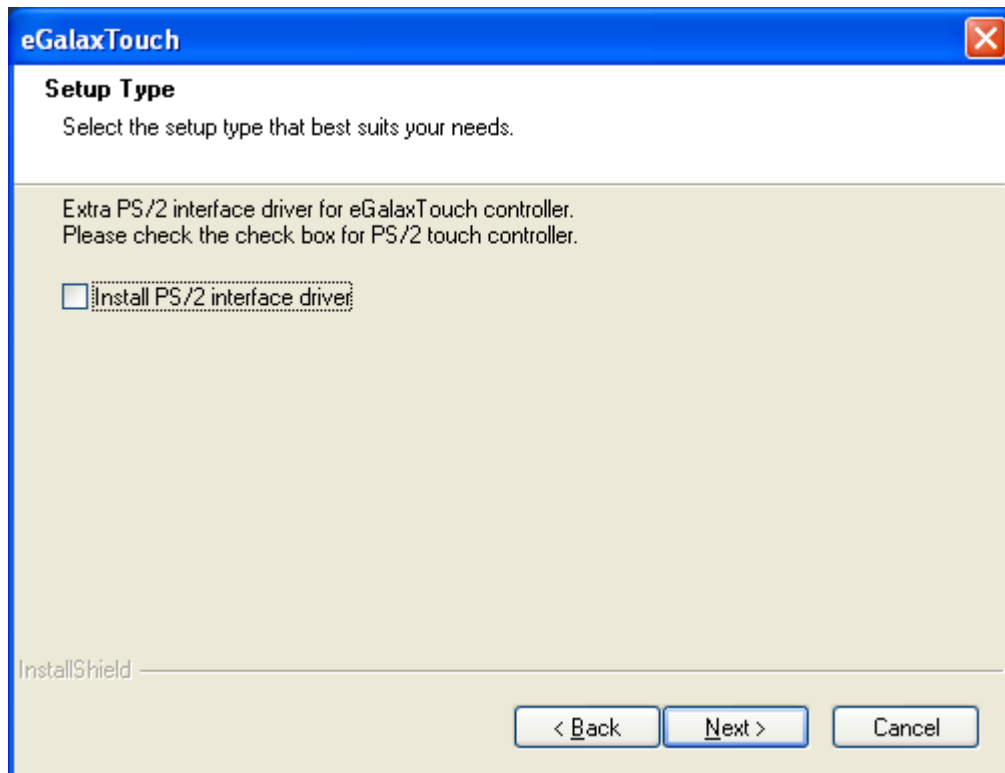

**Step 4.** Click **Install RS232 interface driver**.

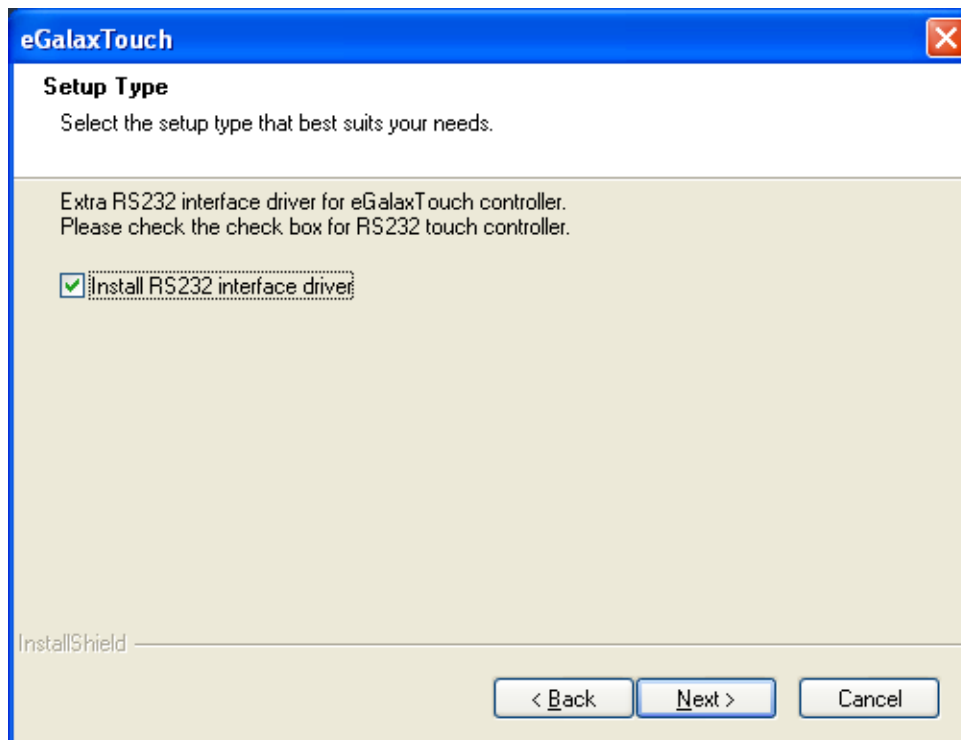

**Step 5. Select None. Click Next.**

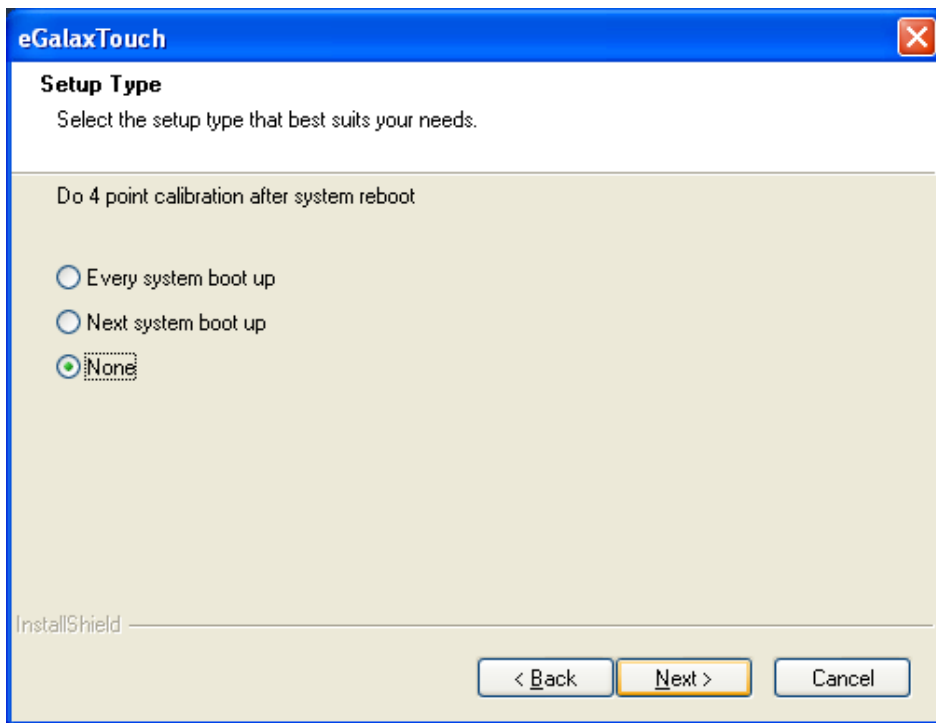

**Step 6. Click OK.**

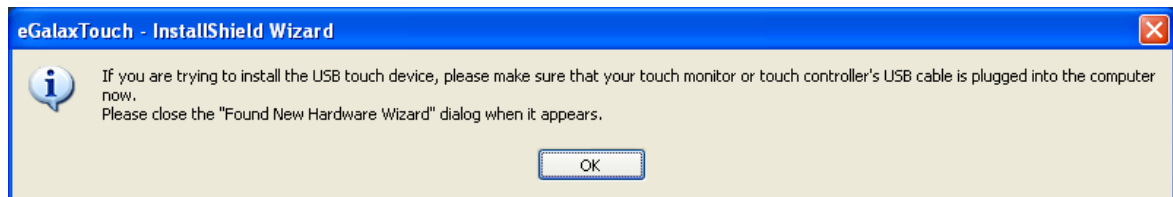

**Step 7. Click Support Multi-Monitor System. Click Next.**

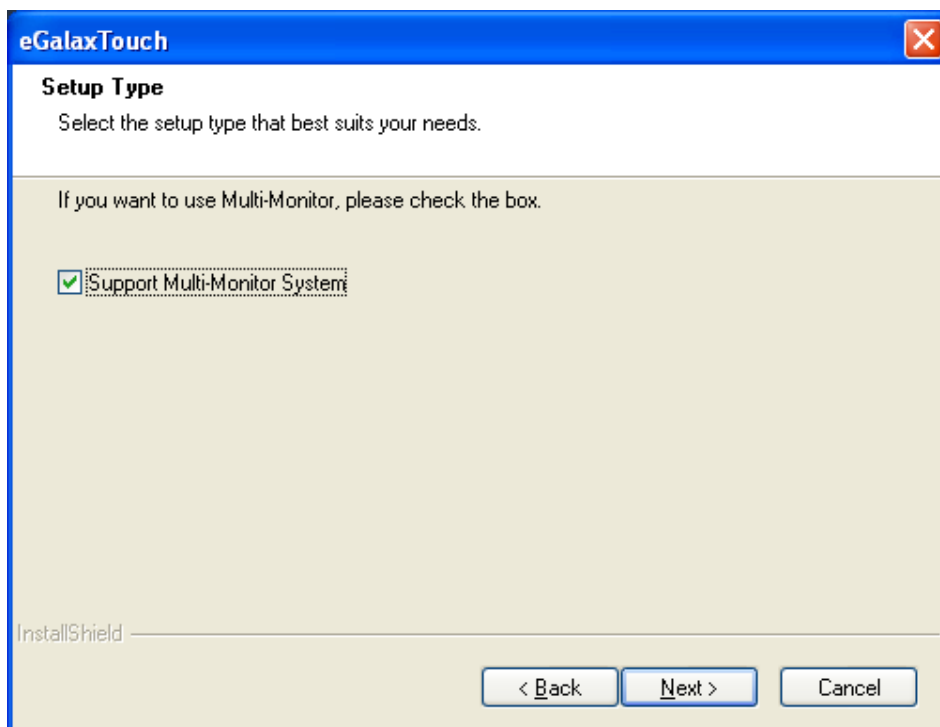

**Step 8.** Go to **C:\Program Files\eGalaxTouch**. Click **Next**.

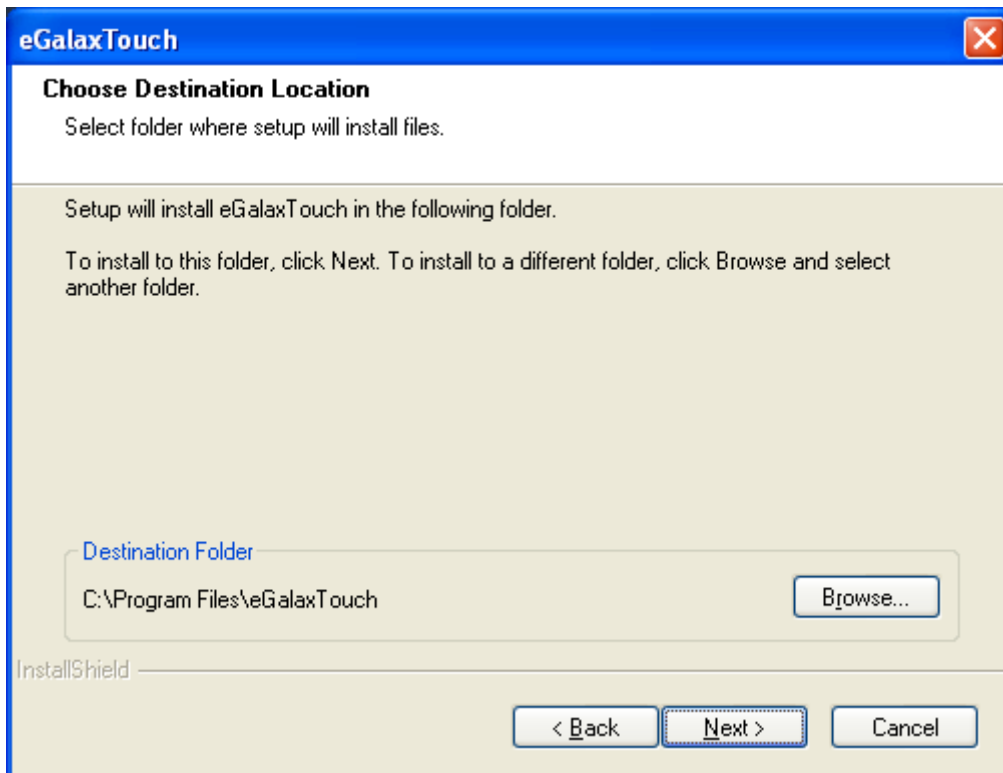

**Step 9.** Click **Next**.

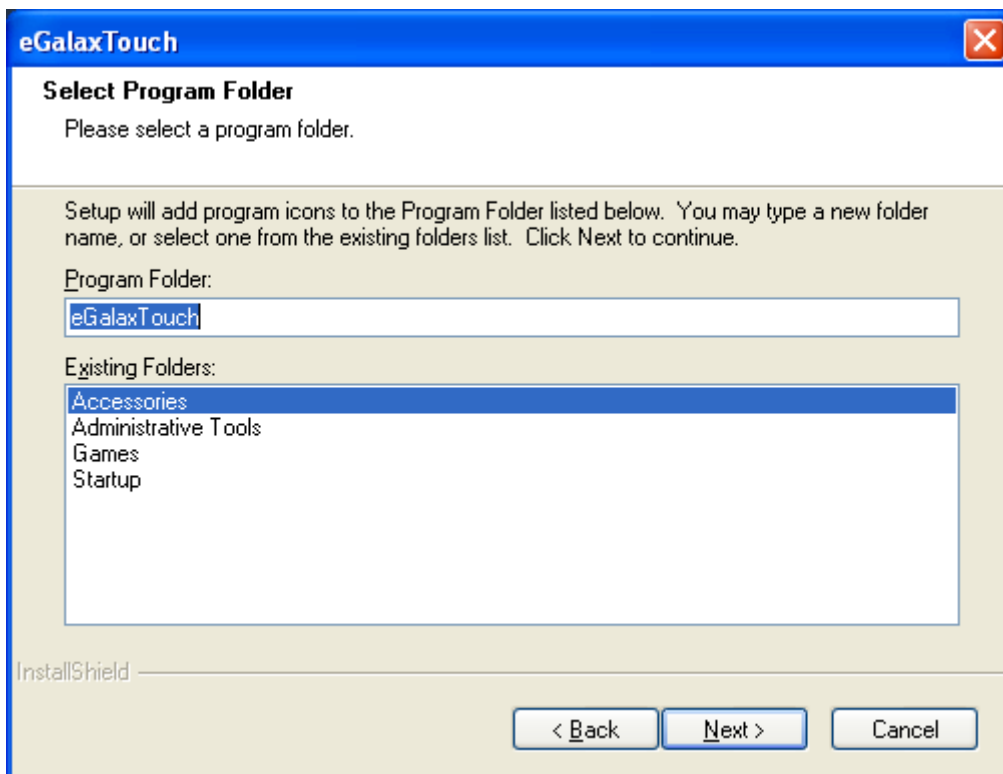



**Step 10.** Click **Create a eGalaxTouch Utility shortcut on desktop.** Click **Next.**

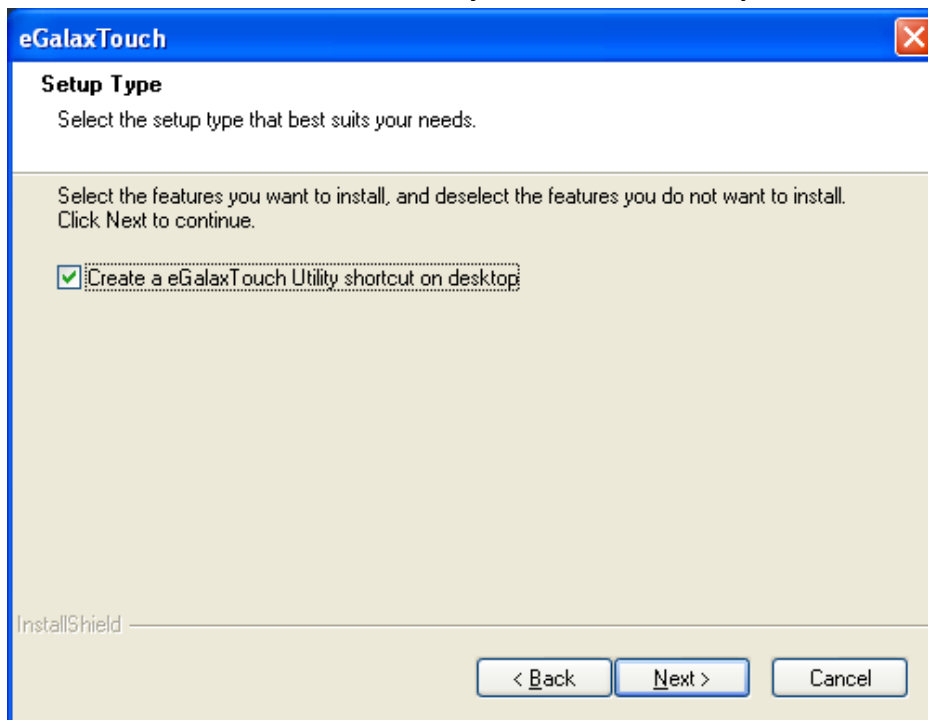

**Step 11.** Wait for installation.

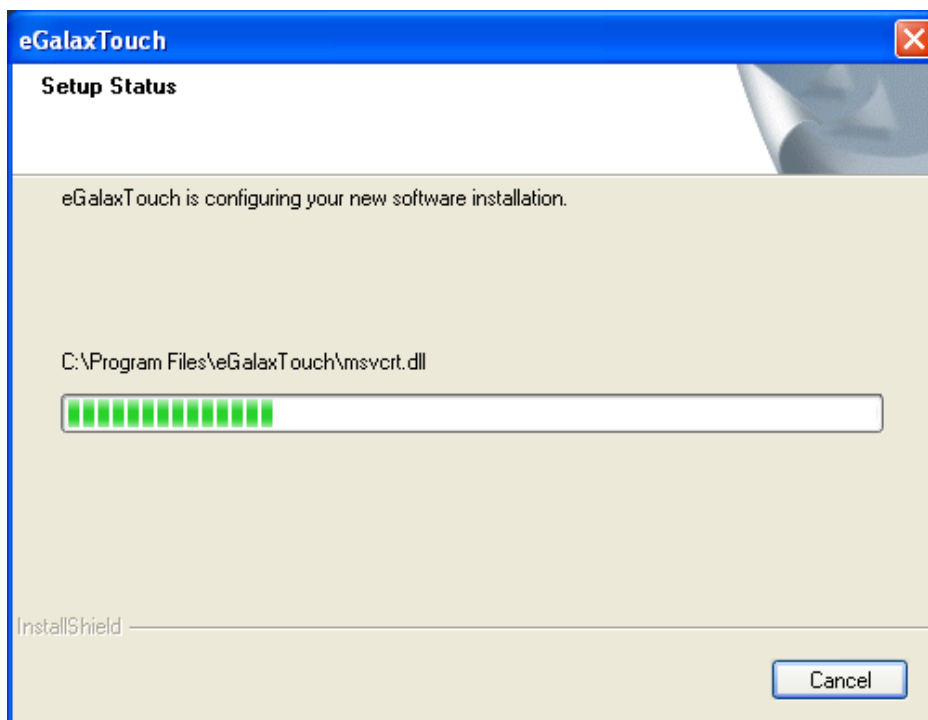

**Step 12.** Click **Yes** to do 4 point calibration.

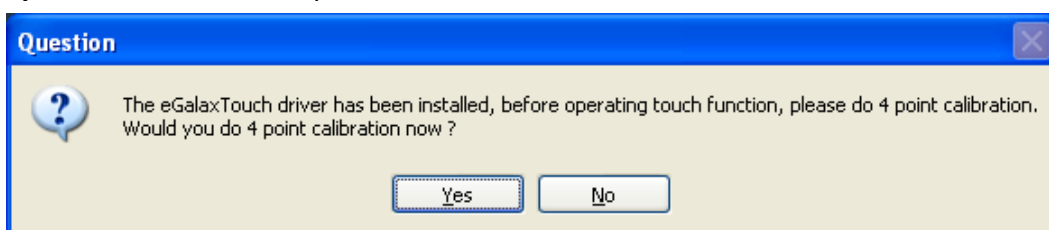

## 3.2 Software Functions

### 3.2.1 Software Functions(Resistive Touch)

Upon rebooting, the computer automatically finds the new 6000 controller board. The touch screen is connected but not calibrated. Follow the procedures below to carry out calibration.

1. After installation, click the PenMount Monitor icon “PM” in the menu bar.
2. When the PenMount Control Panel appears, select a device to “Calibrate.”

#### PenMount Control Panel(Resistive Touch)

The functions of the PenMount Control Panel are **Device**, **Multiple Monitors**, **Tools** and **About**, which are explained in the following sections.

#### Device

In this window, you can find out that how many devices be detected on your system.

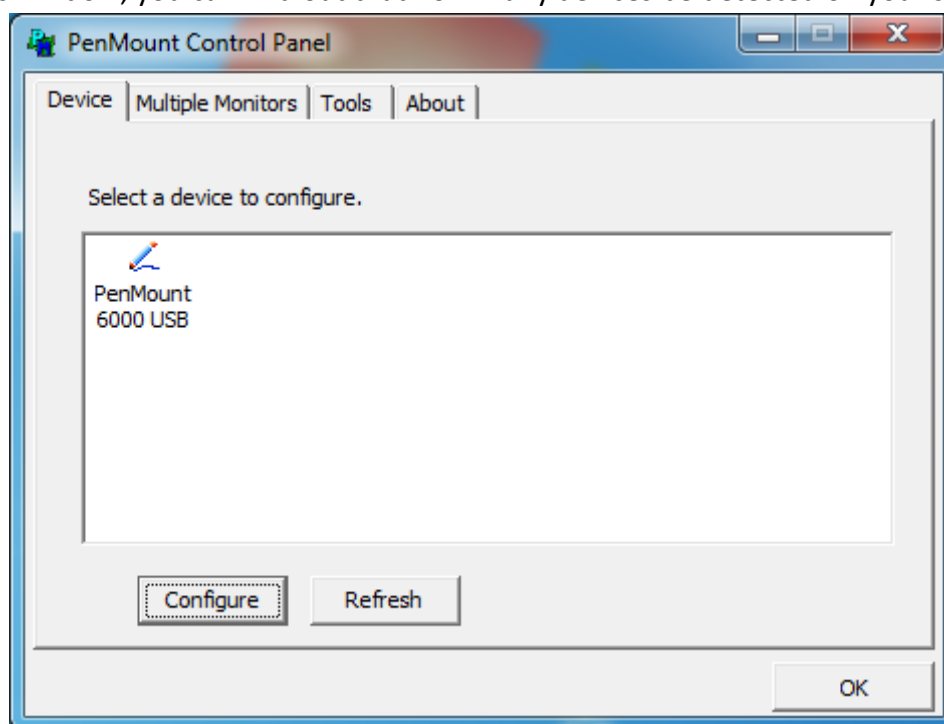

#### Calibrate

This function offers two ways to calibrate your touch screen. ‘Standard Calibration’ adjusts most touch screens. ‘Advanced Calibration’ adjusts aging touch screens.

Standard Calibration	<b>Click this button and arrows appear pointing to red squares. Use your finger or stylus to touch the red squares in sequence. After the fifth red point calibration is complete. To skip, press 'ESC'.</b>
Advanced Calibration	<b>Advanced Calibration uses 4, 9, 16 or 25 points to effectively calibrate touch panel linearity of aged touch screens. Click this button and touch the red squares in sequence with a stylus. To skip, press ESC'.</b>

**Step 1.** Please select a device then click “Configure”. You can also double click the device too.

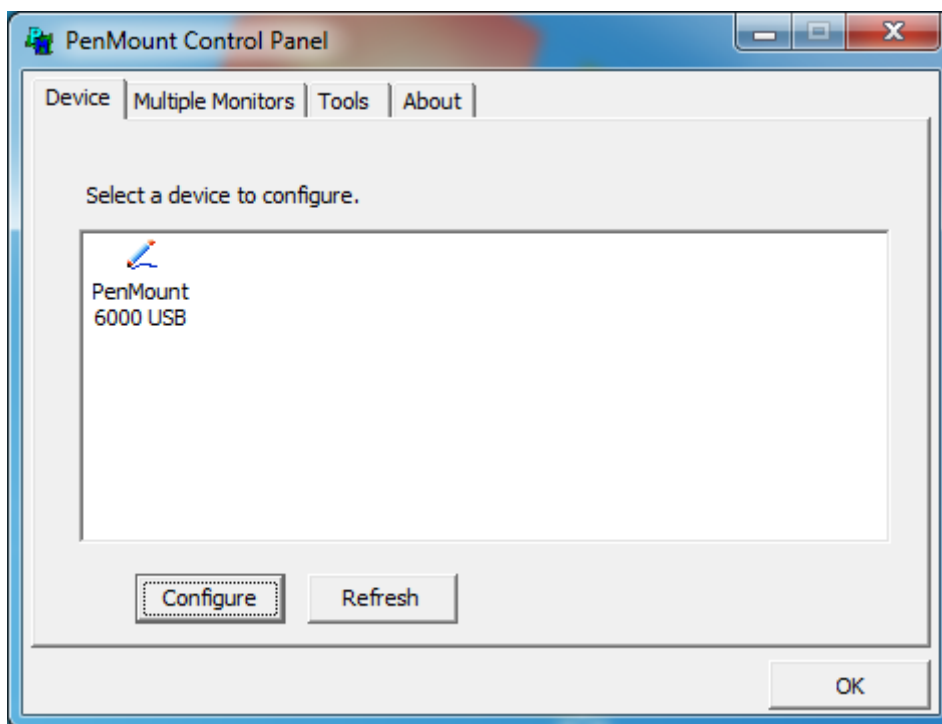

**Step 2.** Click “Standard Calibration” to start calibration procedure

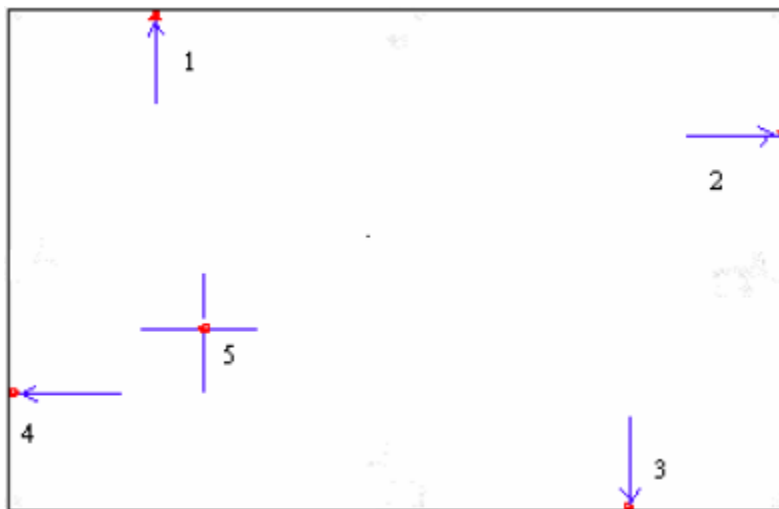
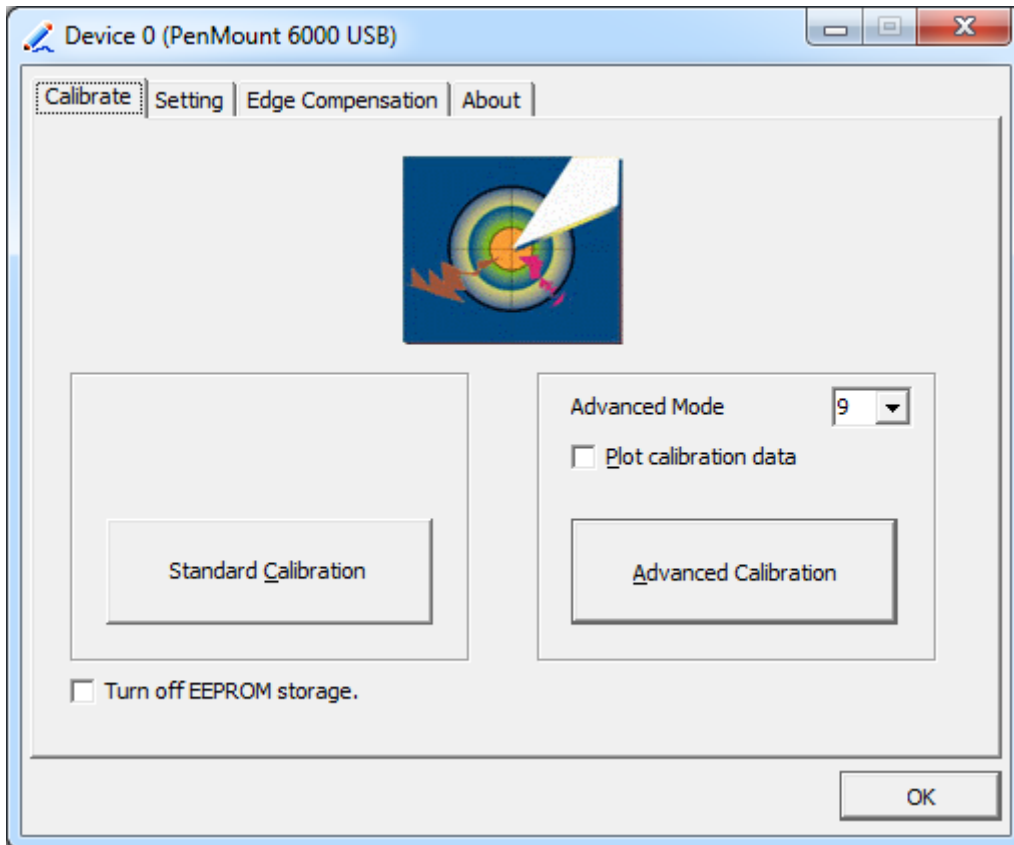

**NOTE:** The older the touch screen, the more Advanced Mode calibration points you need for an accurate calibration. Use a stylus during Advanced Calibration for greater accuracy. Please follow the step as below:

**Step 3.** Select **Device** to calibrate, then you can start to do **Advanced Calibration**.

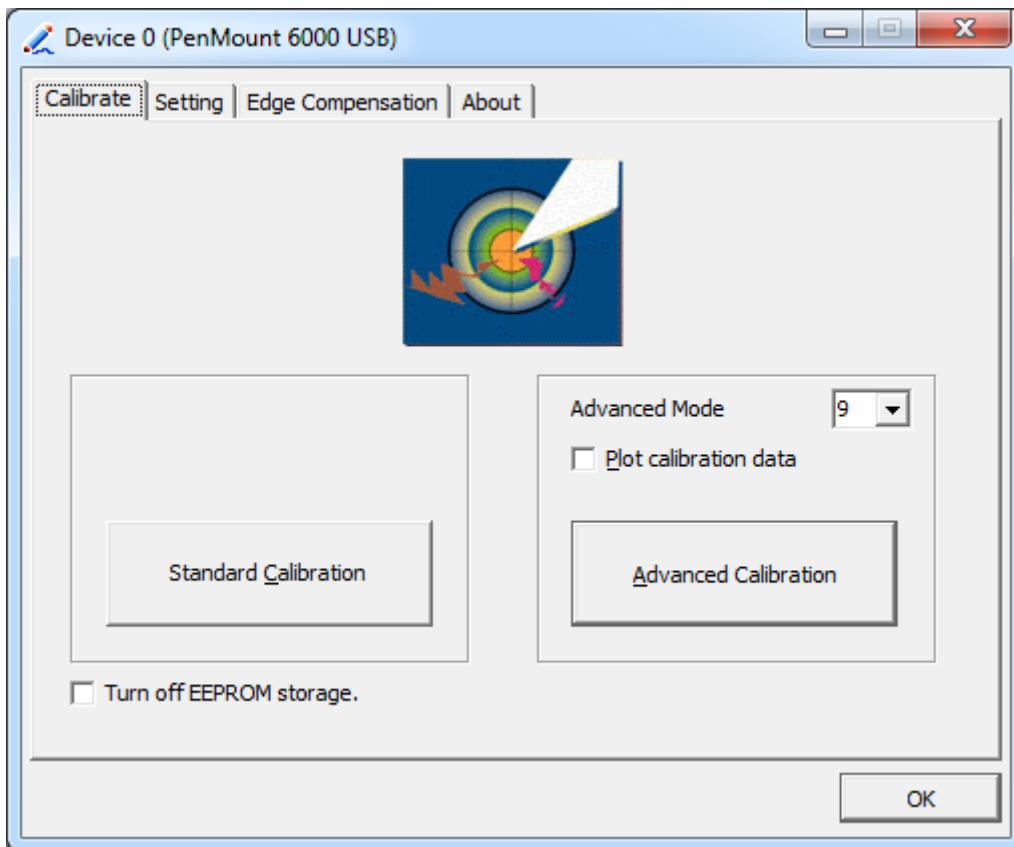

**NOTE:** Recommend to use a stylus during Advanced Calibration for greater accuracy.

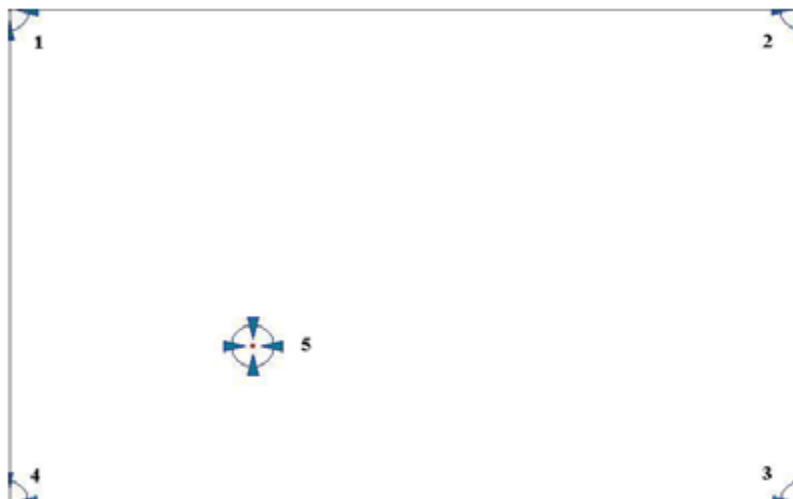

Plot Calibration Data	<b>Check this function and a touch panel linearity comparison graph appears when you have finished Advanced Calibration. The blue lines show linearity before calibration and black lines show linearity after calibration.</b>
Turn off EEPROM storage	<b>The function disable for calibration data to write in Controller. The default setting is Enable.</b>

## Setting

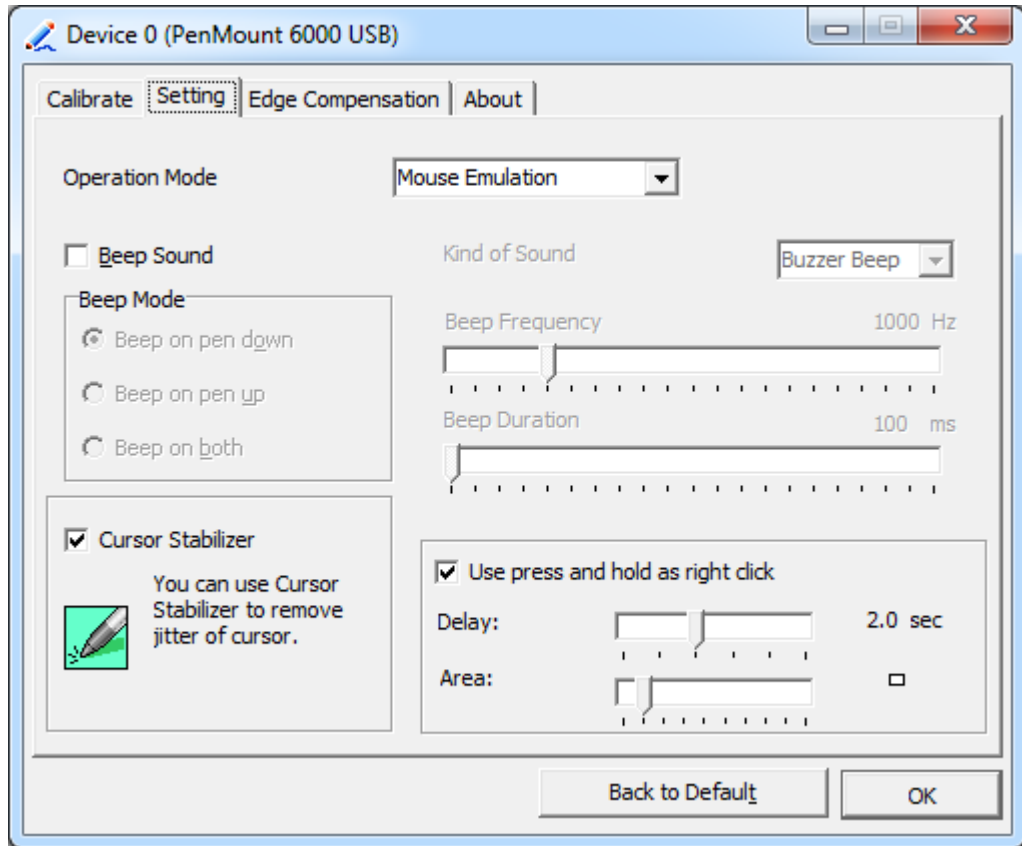

Touch Mode	<p><b>This mode enables and disables the mouse’s ability to drag on-screen icons – useful for configuring POS terminals.</b></p> <p><b>Mouse Emulation – Select this mode and the mouse functions as normal and allows dragging of icons.</b></p> <p><b>Click on Touch – Select this mode and mouse only provides a click function, and dragging is disables.</b></p>
Beep Sound	<p><b>Enable Beep Sound – turns beep function on and off</b></p> <p><b>Beep on Pen Down – beep occurs when pen comes down</b></p> <p><b>Beep on Pen Up – beep occurs when pen is lifted up</b></p> <p><b>Beep on both – beep occurs when comes down and lifted up</b></p> <p><b>Beep Frequency – modifies sound frequency</b></p> <p><b>Beep Duration – modifies sound duration</b></p>
Cursor Stabilizer	<p><b>Enable the function support to prevent cursor shake.</b></p>
Use press and hold as right click	<p><b>You can set the time out and area for you need.</b></p>

## Edge Compensation

You can use Edge Compensation to calibrate more subtly.

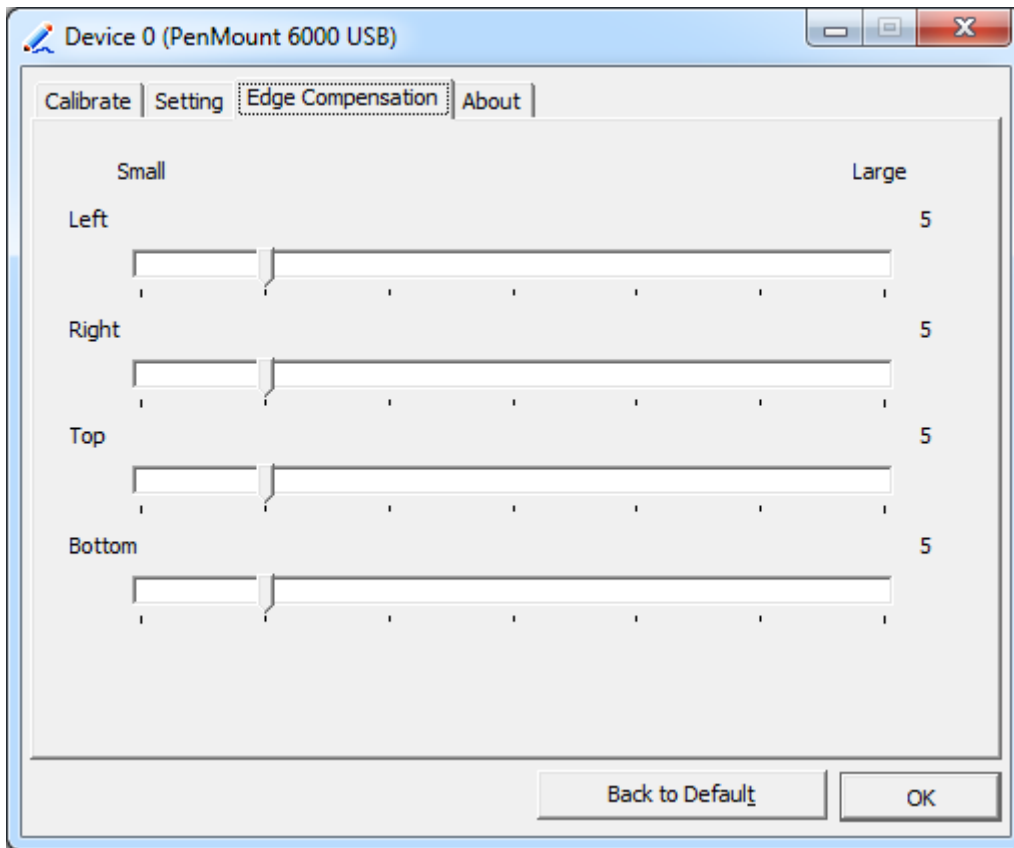

## About

This panel displays information about the PenMount controller and driver version.

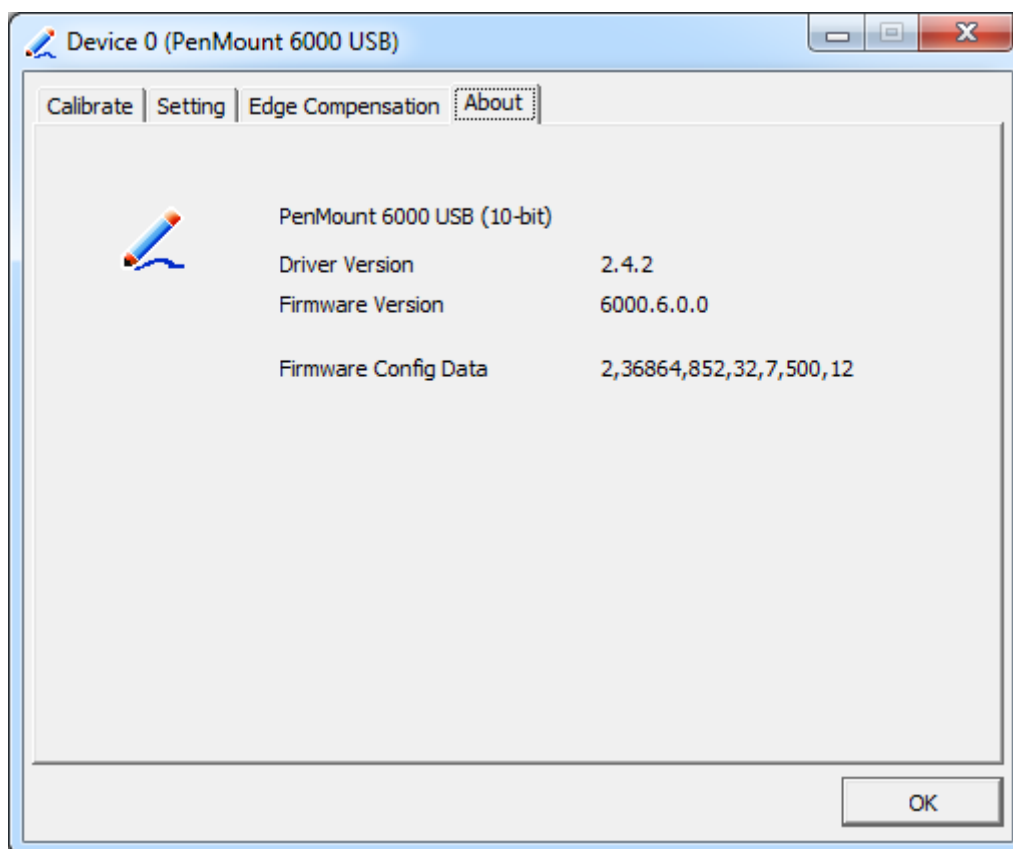

## Multiple Monitors

Multiple Monitors support from two to six touch screen displays for one system. The PenMount drivers for Windows 7 support Multiple Monitors. This function supports from two to six touch screen displays for one system. Each monitor requires its own PenMount touch screen control board, either installed inside the display or in a central unit. The PenMount control boards must be connected to the computer COM ports via the USB interface. Driver installation procedures are the same as for a single monitor. Multiple Monitors support the following modes:

- Windows Extends Monitor Function
- Matrox DualHead Multi-Screen Function
- nVidia nView Function

**NOTE:** The Multiple Monitor function is for use with multiple displays only. Do not use this function if you have only one touch screen display. Please note once you turn on this function the rotating function is disabled.

Enable the multiple display function as follows:

1. Check the **Enable Multiple Monitor Support** box; then click **Map Touch Screens**



to assign touch controllers to displays.

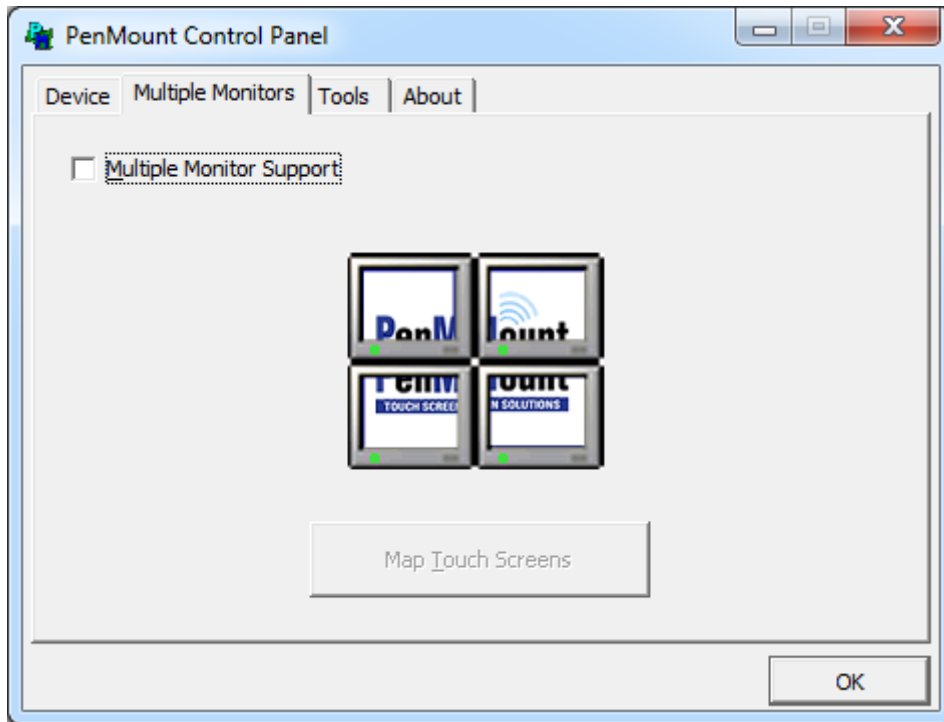

2. When the mapping screen message appears, click **OK**.
3. Touch each screen as it displays “Please touch this monitor”. Following this sequence and touching each screen is called **mapping the touch screens**.

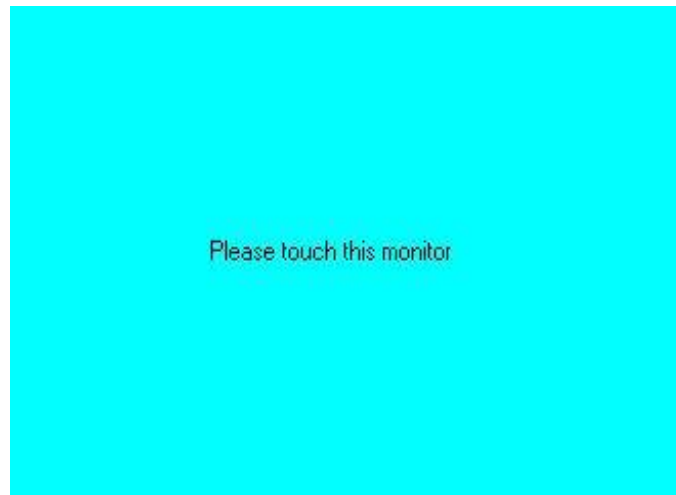

4. Touching all screens completes the mapping and the desktop reappears on the monitors.
5. Select a display and execute the “Calibration” function. A message to start calibration appears. Click **OK**.

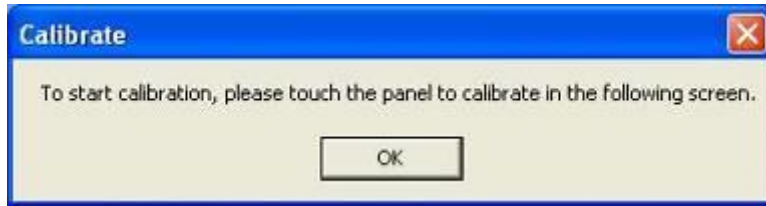

6. "Touch this screen to start its calibration" appears on one of the screens. Touch the screen.
7. "Touch the red square" messages appear. Touch the red squares in sequence.
8. Continue calibration for each monitor by clicking **Standard Calibration** and touching the red squares.

**NOTES:**

1. If you use a single VGA output for multiple monitors, please do not use the **Multiple Monitor** function. Just follow the regular procedure for calibration on each of your desktop monitors.
2. The Rotating function is disabled if you use the Multiple Monitor function.
3. If you change the resolution of display or screen address, you have to redo **Map Touch Screens**, so the system understands where the displays are.

**About**

This panel displays information about the PenMount controller and this driver version.

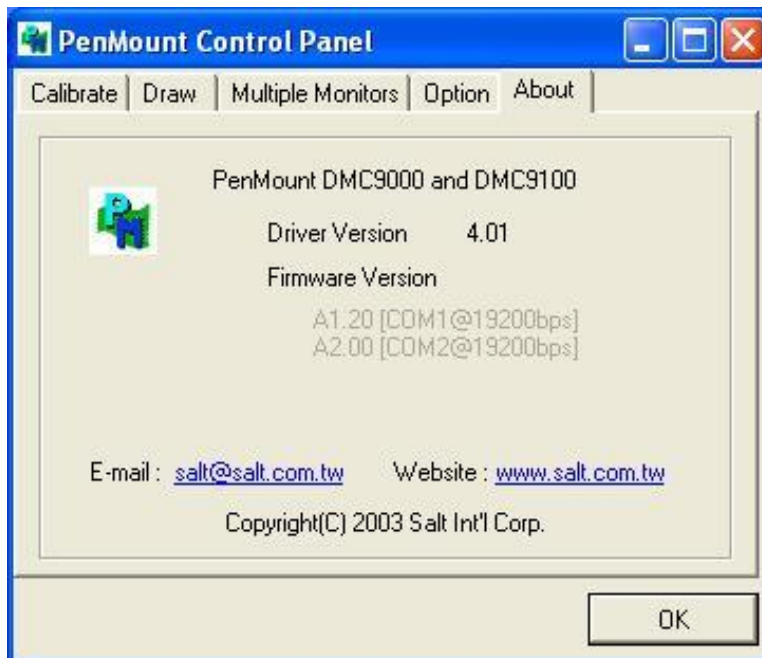

**PenMount Monitor Menu Icon**

The PenMount monitor icon (PM) appears in the menu bar of Windows 7 system when you turn on PenMount Monitor in PenMount Utilities.



PenMount Monitor has the following function



Control Panel	<b>Open Control Panel Windows</b>
Beep	<b>Setting Beep function for each device</b>
Right Button	<p><b>When you select this function, a mouse icon appears in the right-bottom of the screen.</b></p> <p><b>Click this icon to switch between Right and Left Button functions.</b></p> 
Exit	<b>Exits the PenMount Monitor function.</b>

### Configuring the Rotate Function

1. Install the rotation software package.
2. Choose the rotate function (0°, 90°, 180°, 270°) in the 3rd party software. The calibration screen appears automatically. Touch this point and rotation is mapped.

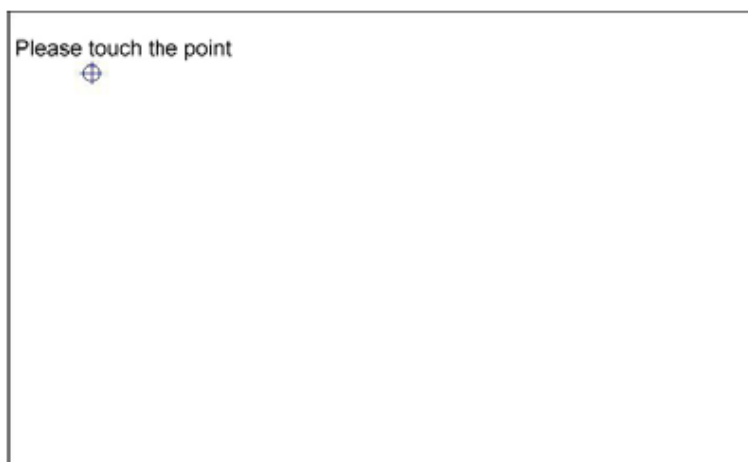

**NOTE:** The Rotate function is disabled if you use Monitor Mapping

## 3.2.2 Software Functions(Projected Capacitive)

### General

In this window, you can see there is USB Controller. Click **OK** to continue.

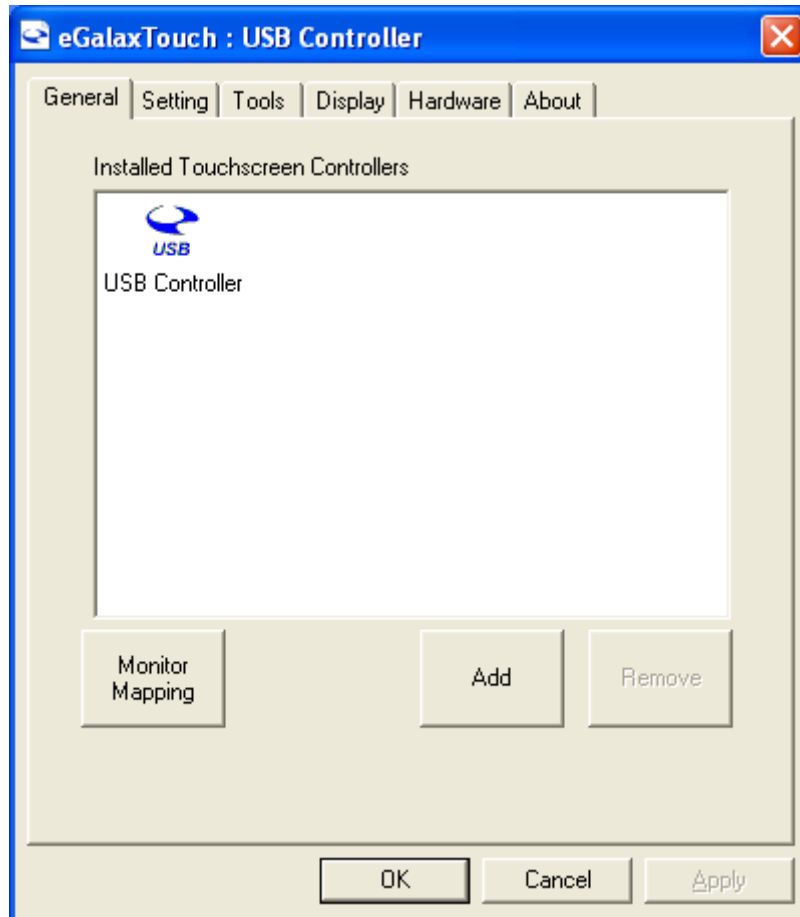

#### **Monitor Mapping**

to adjust touch panel

#### **Add**

to search for device

## Setting

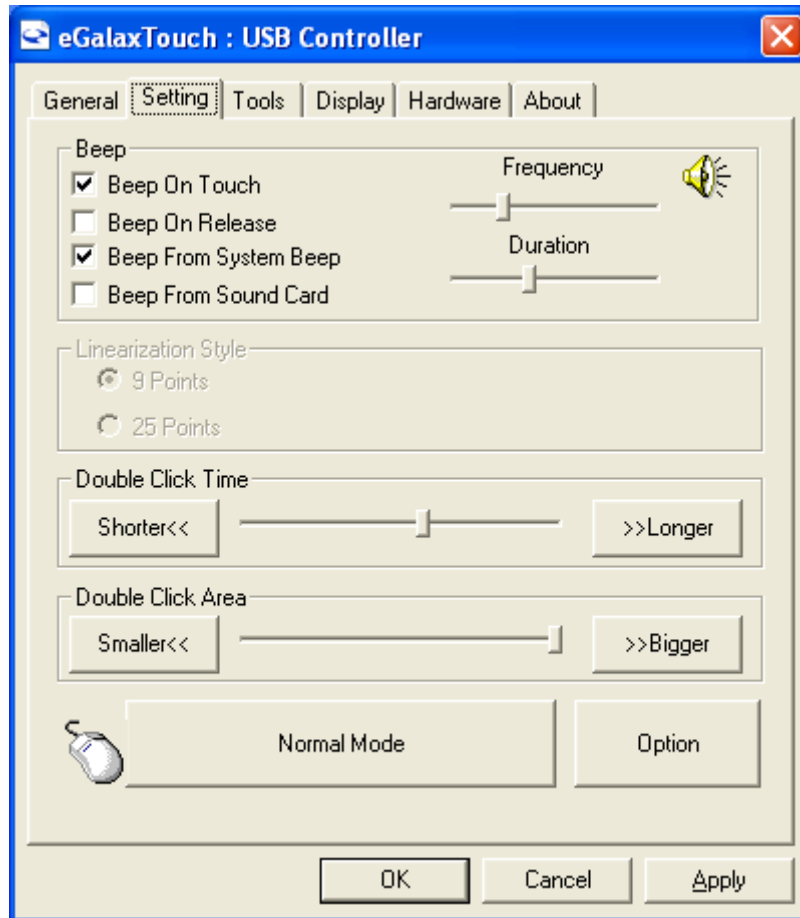

### Beep

- Beep On Touch
- Beep On Release
- Beep From System Beep
- Beep From Sound Card

### Linearization Style

- 9 points
- 25 points

### Double Click Time

- Shorter
- Longer

### Double Click Area

- Smaller
- Bigger

### Normal mode

- Simulate the mouse mode

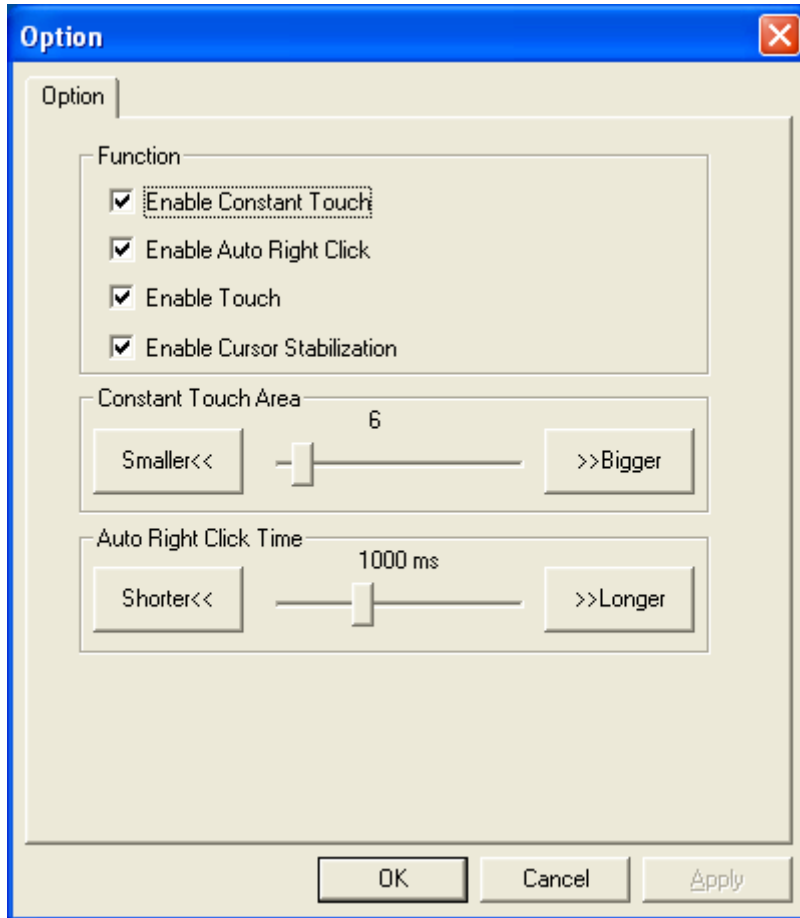

### Option

Function

Enable Constant Touch

Enable Auto Right Click

Enable Touch

Enable Cursor Stabilization

Constant Touch Area

Auto Right Click Time

## Tools

Click **OK** to continue the settings.

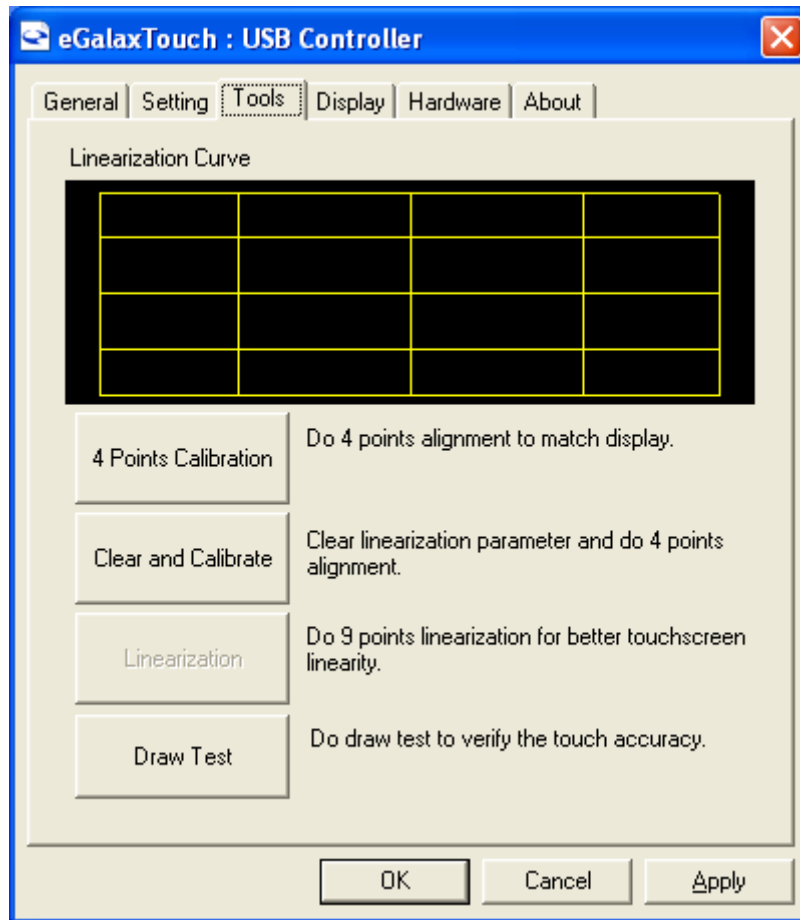

### **4 Points Calibration**

Do 4 points alignment to match display.

### **Clear and Calibrate**

Clear linearization parameter and do 4 points alignment.

### **Linearization**

Do 9 points linearization for better touchscreen linearity.

### **Draw Test**

Do draw test to verify the touch accuracy.

## Display

In this window, it shows the mode of display.

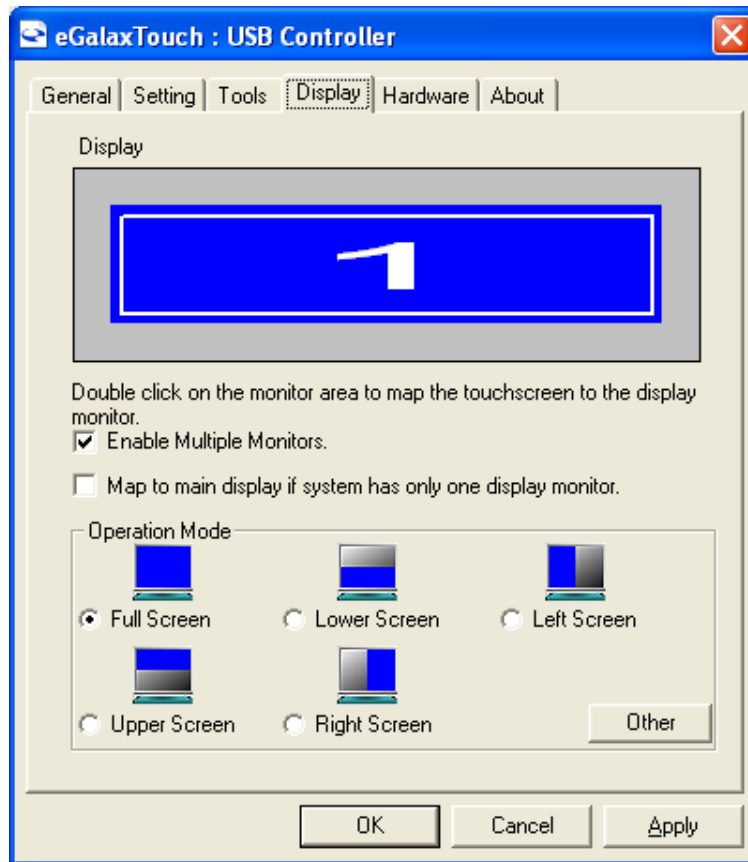

**Enable Multiple Monitors.**

**Map to main display if system has only one display monitor**

Full Screen

Lower Screen

Left Screen

Upper Screen

Right Screen



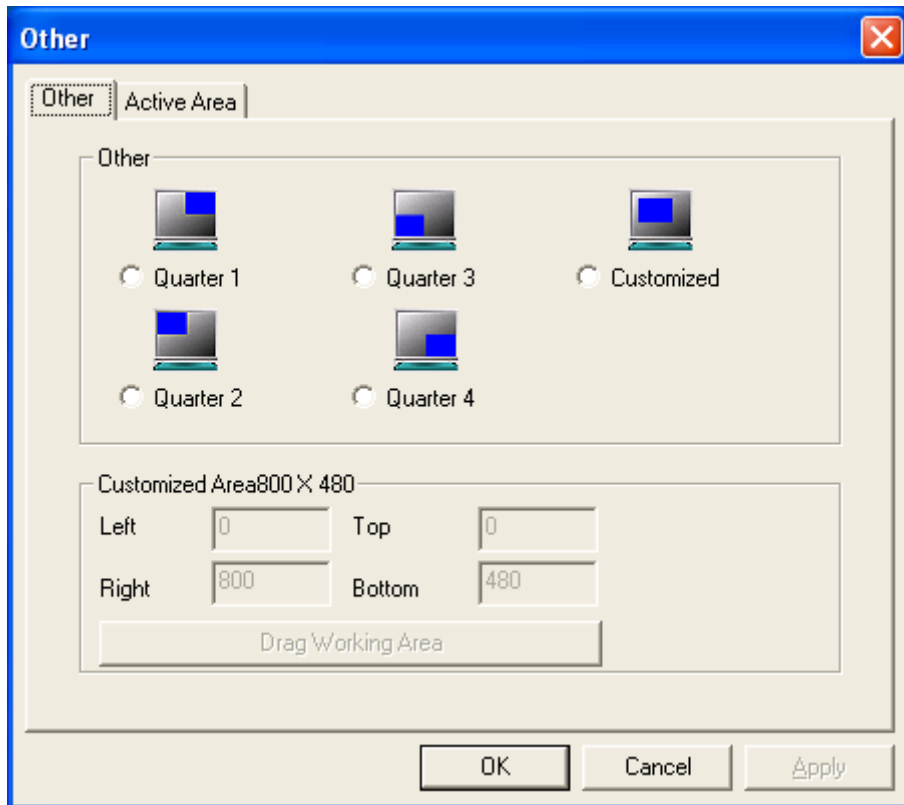

**Other**

Other mode of display. Quarter1~4 and Customized area.

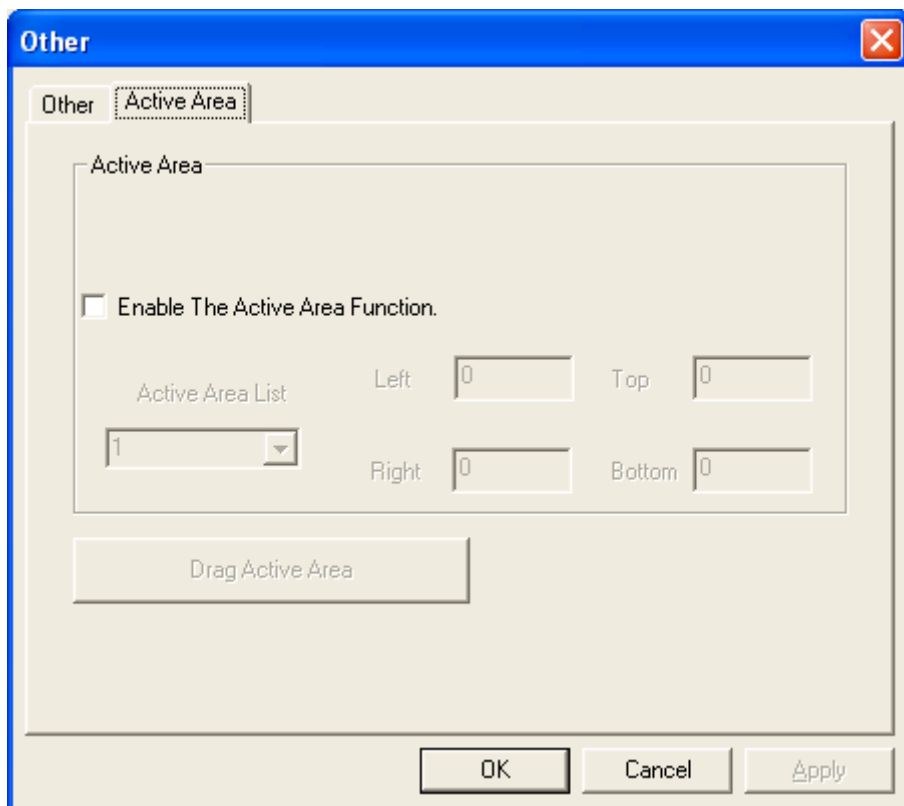

**Active Area**

Drag active area to enable Active Area Function.

## Hardware

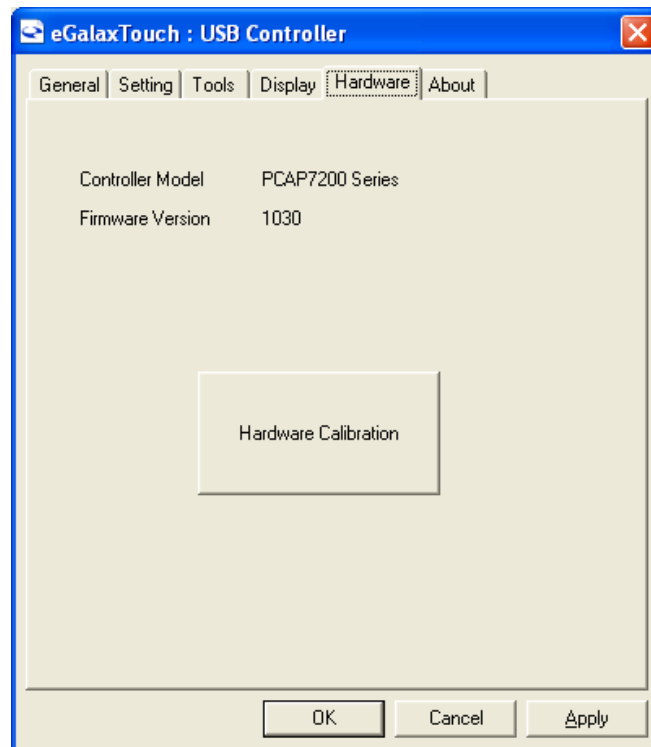

## Saturn Hardware Configuration

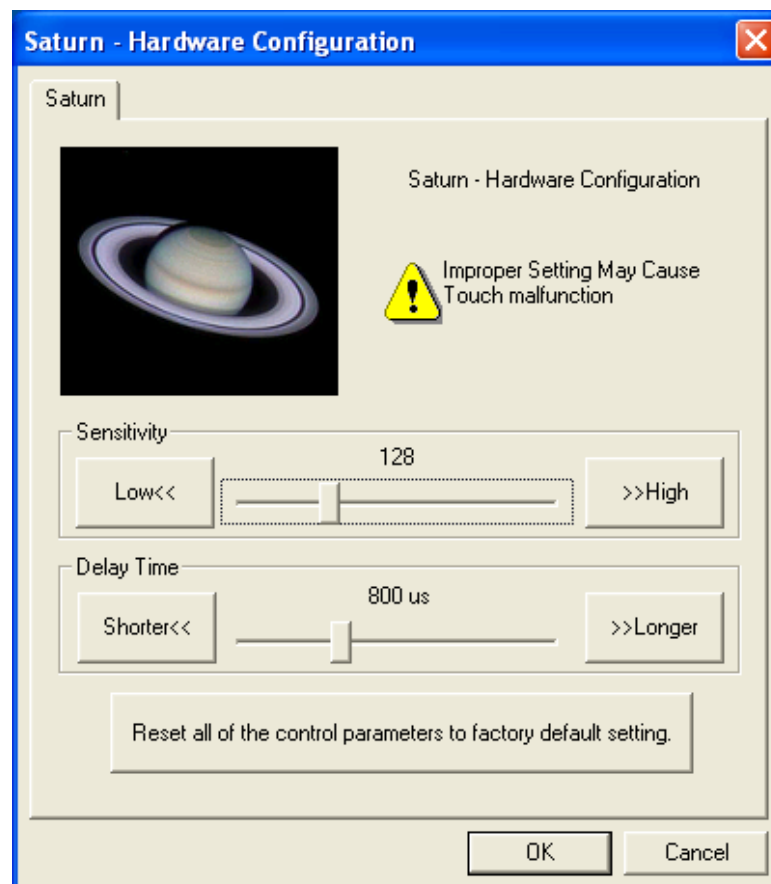

## About

To display information about eGalaxTouch and its version.

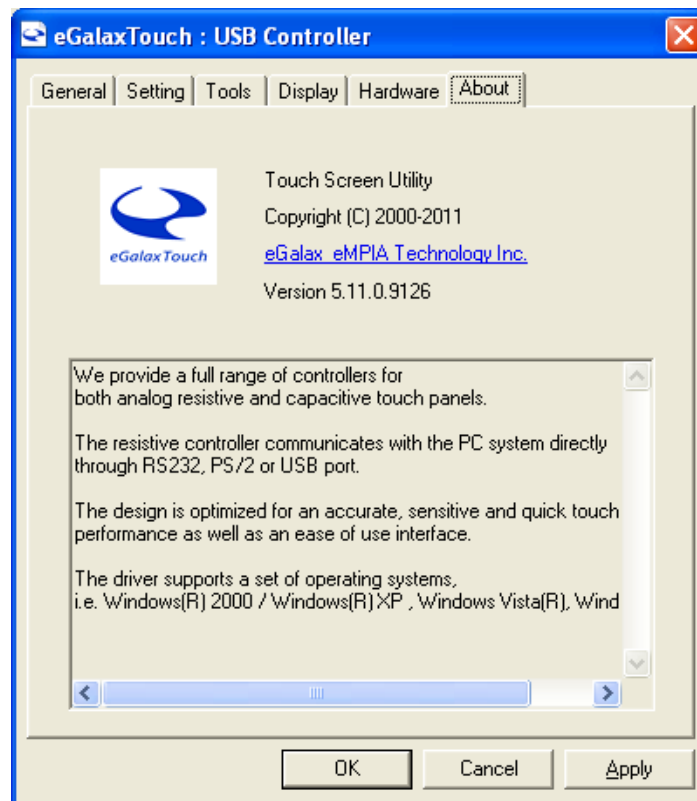

# Appendix A:

# Board Dimensions

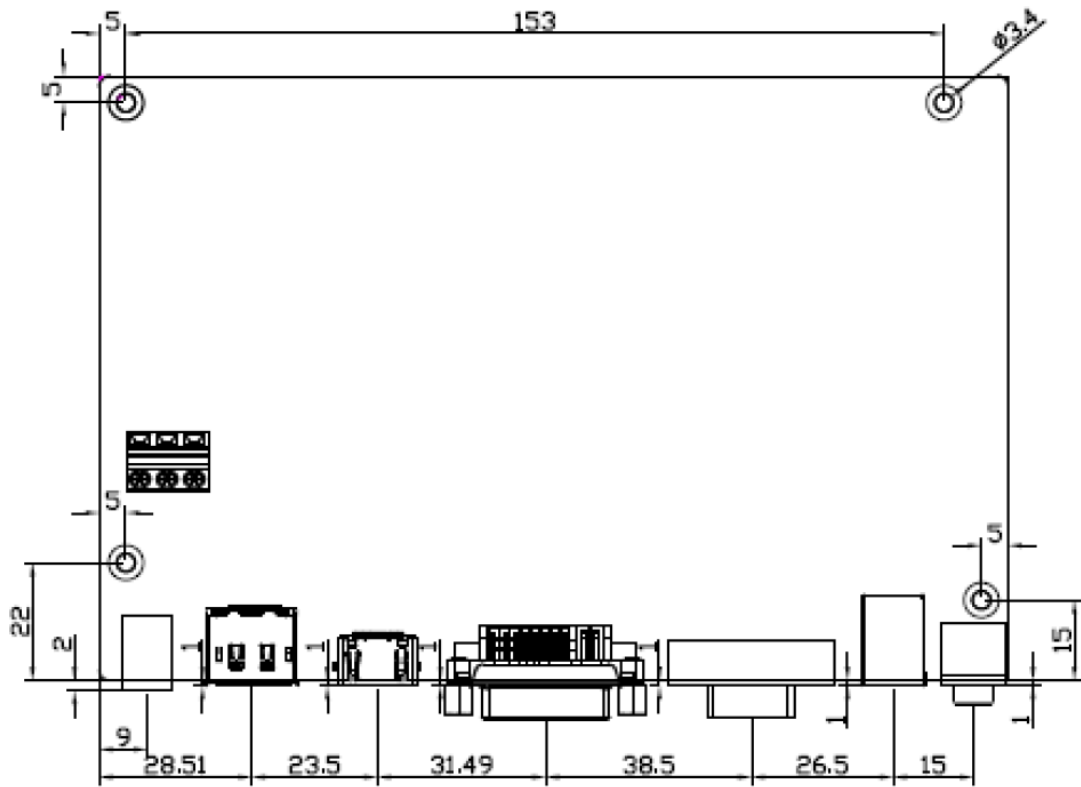

Figure A: Dimensions of TB-6802

## **Appendix B: Yoke Mounting and VESA Mounting**

The ViTAM-1XX Series model can be Yoke mounted and VESA mounted as shown in Picture below.



**Figure B: Yoke mounting of ViTAM-1XX Series**



**Figure C: VESA mounting of ViTAM-1XX Series**