



HCR-3

Collaborative Robot

User Manual

Preface

Before installing the product, please read this manual fully and make sure you follow the instructions in it.

The content of the manual is maintained latest as of the date when it is written. The product information is subject to change without prior notice to users.

If you are uncertain about any requirements, recommendations or safety procedures described in the manual, please, consult with Hanwha Precision Machinery Co.

Users are responsible for any damages caused by their misuse neglecting these instructions below.

Note

- Some of illustrations in the manual intends to help users in understanding the system concepts and installation issues. The actual product may differ from the manual.
- Please keep this manual in a safe place for future reference.
- Voltage: 100~240VAC, 50/60Hz(1kW)(It should be connected to the neutral cable which is connected with grounding line with one phase of the 3 phase cables.)
- Status of load installation: Load is not exceeding the payload of Robot.
- Please check the grounding line connection in plant and operating cell. (It can be refer to section 3.3 to check the location of grounding line.)
 - Any plants and cells with the inappropriate grounding line may have the negative influence such as noise on the communication line between robot and system.
 - Especially, if robot is installed with the equipment requiring large current such as heater, motor, separate additional grounding line is required.

Copyrights

The copyrights and intellectual property rights of all the content and diagrams in the manual belong to Hanwha Precision Machinery Co.

Thus, illegal use, duplication, distribution or dissemination of the manual without prior written approval by Hanwha Precision Machinery Co. is strictly prohibited and such an activity is an infringement of the intellectual property rights of Hanwha Precision Machinery Co.

Users are responsible for any damages caused by their misuse or modification of the patent rights for the equipment.

The information provided by the manual is deemed trustworthy by Hanwha Precision Machinery Co. Hanwha Precision Machinery Co. is not responsible for any situations arising due to inaccuracy or typo in the content of the manual.

The information provided in the manual is subject to change without prior notice and for more details about revisions made in the manual, please visit the homepage of Hanwha Precision Machinery Co.(<http://www.hanwharobotics.com>)

© 2019 Hanwha Precision Machinery Co., Ltd. All rights reserved

Table of Contents

PREFACE	3
COPYRIGHTS	4
CHAPTER 1	PRODUCT OVERVIEW	13
1.1	COLLABORATIVE ROBOT SYSTEM.....	13
1.2	SYSTEM COMPONENTS	15
1.3	BASIC SYSTEM CONFIGURATION	16
1.4	OVERVIEW OF ROBOT ARMS.....	17
1.5	OVERVIEW OF ROBOT CONTROLLER	19
	Front.....	19
	Bottom.....	20
1.6	OVERVIEW OF TEACHING PENDANT.....	21
	Front.....	21
	Rear	22
1.7	AXIAL COORDINATES AND OPERATIONAL RANGE	23
1.8	ROBOT'S WORKING RANGE	25
1.9	MAXIMUM LOAD CAPACITY FOR THE TOOL.....	26
CHAPTER 2	SAFETY	27
2.1	SAFETY MARKS IN THE USER MANUAL.....	27
2.2	GENERAL SAFETY CAUTIONS	28
2.3	INTENDED USE.....	29
2.4	POTENTIAL DANGERS	30
2.5	LIMITATION OF LIABILITY	30
2.6	TRANSPORTATION	31
2.7	EMERGENCY STOP	32
	Using emergency stop	32
	Canceling emergency stop	32
2.8	SAFETY FENCE	33
2.9	LIMITS OF SPEED AND ROTATIONAL ANGLES	34
2.10	OPERATING ROBOTS WITHOUT DRIVING POWER	34
2.11	SAFETY CONTROLLER.....	34
2.12	RISK ASSESSMENT	34
CHAPTER 3	INSTALLATION	36
3.1	INSTALLATION LOCATIONS.....	36
3.2	INSTALLATION TYPES.....	37

Table of Contents

3.3	FIXING ROBOTS.....	39
3.4	CONNECTING TOOLS TO ROBOTS.....	40
3.5	CONNECTING CABLES.....	41
	Connecting the teaching pendant to the robot controller.....	41
	Connecting the robot arm to the robot controller.....	41
	Connecting the power supply to the robot controller.....	42
3.6	FIXING THE CONTROLLER BOX.....	43
3.7	OVERVIEW OF CONTROLLER I/O.....	44
3.8	COMMON SPEC FOR DIGITAL I/O.....	44
3.9	CONFIGURING THE SAFETY INPUT.....	47
	Initial safety configuration.....	48
	Connecting the emergency stop button.....	49
	Safety protection stop and restart.....	49
3.10	CONFIGURING THE GENERAL DIGITAL I/O.....	50
	Load control with digital outputs.....	50
	Digital input control using buttons.....	51
	Communicating with other equipment or PLC.....	51
3.11	CONFIGURING THE GENERAL ANALOG I/O.....	52
	Analog output.....	53
	Analog input.....	53
CHAPTER 4	GETTING STARTED.....	54
4.1	TURNING ON THE ROBOT CONTROLLER.....	54
4.2	TURNING ON THE TEACHING PENDANT.....	55
CHAPTER 5	SOFTWARE OVERVIEW.....	56
5.1	MENU OVERVIEW.....	56
	Expanding menu.....	56
	Robot Operation.....	56
	Programming.....	56
	Monitoring.....	57
	Robot Setting.....	57
	Safety Setting.....	57
	Device Setting.....	57
	Management.....	57
	SW Configuration.....	57
	Message.....	57
	Manual Move.....	57
5.2	3D PREVIEW SCREEN.....	58

Screen display setting button	58
Robot task control button	59
5.3 MANUAL MOVE SCREEN	60
5.4 VIRTUAL KEYPAD.....	62
Text keypad.....	62
Number keypad.....	63
Expression keypad.....	63
CHAPTER 6 REGISTERING ROBOTS AND USERS	65
6.1 MANAGING ROBOTS.....	65
Registering robots.....	66
Deleting robots	66
Modifying the robot name.....	67
6.2 MANAGING USERS.....	68
Adding users and setting authorities	68
Menu available to each authority	69
6.3 LOGIN/LOGOUT	70
Logging in.....	70
Logging out	71
6.4 CHECKING STATUS.....	71
Checking robot status.....	71
Checking errors.....	71
Checking the software version.....	72
CHAPTER 7 SETTING ROBOTS.....	73
7.1 SETTING THE ROBOT INSTALLATION ANGLES.....	73
7.2 SETTING TCP	74
Creating a new TCP profile	75
Calculating the TCP position.....	77
Setting the TCP orientation	80
Changing the TCP profile name	82
Editing the TCP profile.....	82
Deleting the TCP profile	83
7.3 SETTING INPUTS/OUTPUTS.....	84
Types of digital I/O	84
Editing the digital inputs settings.....	85
Editing the digital outputs settings.....	85
Types of analog I/O	86
Editing the analog I/O setting.....	87

Table of Contents

7.4	COORDINATES.....	88
	Registering points.....	88
	Registering line coordinates.....	89
	Registering plane coordinates.....	89
7.5	SETTING GLOBAL VARIABLES.....	90
7.6	I/O BIT OPERATION.....	91
	Add/Delete.....	91
	I/O bit operation settings.....	91
CHAPTER 8	SAFETY SETTINGS.....	92
8.1	LIMITING ROBOT MOVEMENT.....	92
	Default settings.....	93
	Manual setting method.....	93
8.2	SETTING SAFETY BOUNDARIES.....	95
	Adding safety boundary planes.....	95
	Viewing safety boundary planes.....	96
	Applying safety boundaries.....	97
	Changing the name of safety boundaries.....	98
	Deleting safety boundary settings.....	98
8.3	SETTING TOOL BOUNDARIES.....	100
	Adding Tool Safety Boundary Surfaces.....	100
	Setting Tool Safety Boundary Surfaces.....	101
	Applying Tool Safety Boundary Surfaces.....	101
8.4	SETTING REDUNDANT I/O.....	102
8.5	SETTING SAFEGUARD I/O.....	104
8.6	EXCEEDING SAFETY LIMIT OF JOINTS.....	105
CHAPTER 9	PROGRAMMING.....	106
9.1	HOW TO USE COMMANDS.....	106
	Selecting a flowchart.....	106
	Type of commands.....	107
	Additional Commands.....	108
	Entering commands.....	109
	Check Icon Status.....	109
	Changing command names.....	109
	Deleting commands.....	110
	Searching Commands.....	110
	Skipping Commands.....	110
	Tree.....	111
9.2	SETTING VARIABLES.....	112

	Adding variables	112
	Modifying variables	113
	Deleting variables	113
	Variable Monitoring	113
9.3	EDITING PROGRAMS.....	114
	Overview of edit menu	114
	Example of program editing	115
	Undo Function.....	116
9.4	MANAGING A PROGRAM	117
	Saving a program.....	117
	Making a new program.....	117
	Loading a program.....	118
	Deleting a program.....	118
	Export as script	119
	Export Program File	119
9.5	USING TEMPLATES	120
	Saving as a template	120
	Loading a template	121
	Deleting a template	121
9.6	APPLYING PROGRAMS	122
9.7	MOVE COMMAND	123
	Selecting a movement method	123
	Radius of Linear	125
	Don't stop at this point	125
	Blending.....	125
	Advanced.....	127
	Setting the coordinates for movement	127
	Displaying as groups.....	128
9.8	IF COMMAND.....	129
9.9	LOOP COMMAND	130
9.10	SWITCH COMMAND	131
9.11	WAIT COMMAND.....	132
9.12	SET COMMAND	133
9.13	FOLDER	134
	Change Programed Icons into Folder	134
	Create New Folder	134
9.14	MESSAGE.....	135
	Output format	135

Table of Contents

	Message operation	135
	Message format	136
	Select message	136
9.15	PATTERN COMMAND	137
	Pattern types	137
	Setting the pattern coordinates	138
	Setting repeat counts.....	138
	Advanced commands for patterns	139
	Setting pattern points.....	140
9.16	USING A SUB PROGRAM	141
	Making a sub program.....	141
	Saving and loading a sub program	142
	Entering a sub program	142
9.17	CONVEYOR	144
	Conveyor Setting	144
	Conveyor Start Options.....	145
	Setting Conveyor Command.....	145
9.18	VISION COMMAND.....	146
	Setting basic options	146
	Setting the movement speed.....	146
	Setting the movement location.....	147
9.19	THREAD	148
	Thread Tab.....	148
	Thread Creation	148
	Event Tab	149
9.20	SCRIPT	150
	Script Viewer	150
9.21	PATH COMMAND	151
	Recording Paths.....	151
CHAPTER 10	STARTING THE ROBOT	153
	Turning ON/OFF the robot	154
	Monitoring	154
	Checking and setting the robot operation data	155
	Operating the robot.....	155
	Locking Screen	157
CHAPTER 11	MONITORING	158
11.1	MONITORING THE ROBOT.....	158

Monitoring the robot positions	158
Checking the robot status.....	159
11.2 MONITORING INPUTS/OUTPUTS	159
Monitoring controller inputs/outputs.....	160
Monitoring tool inputs/outputs.....	161
11.3 UTILIZATION	162
CHAPTER 12 DEVICE SETTING	163
12.1 CONFIGURING MODBUS TCP	163
Registering Devices	164
Editing/copying the device settings.....	165
Registering I/O	166
Viewing the communication status.....	168
Viewing and setting the I/O values.....	168
Editing I/O settings.....	169
Deleting I/O.....	169
12.2 USING A VISION SYSTEM.....	170
12.3 ADDING AND SETTING VISION EQUIPMENT	171
Adding a vision equipment	171
Setting a vision equipment	171
12.4 SETTING VISION WORKSPACE	173
Adding Vision Workspace	173
Understanding rotation offsets.....	174
CHAPTER 13 ENVIRONMENT SETTING	176
13.1 GENERAL SETTING.....	176
13.2 NETWORK SETTING	177
CHAPTER 14 TURNING OFF THE SYSTEM.....	178
14.1 SHUTTING DOWN THE OPERATION SOFTWARE.....	178
14.2 TURNING OFF CONTROLLERS.....	178
CHAPTER 15 MAINTENANCE.....	179
15.1 INSPECTION ITEMS AND PERIODS	179
15.2 CHECKING THE ROBOT ARM.....	180
Inspection period	180
Checking and cleaning the robot arm.....	180
15.3 CHECKING THE CONTROLLER	180
Inspection period	180
Checking and cleaning the controller	180

Table of Contents

Cleaning and replacing the filter.....	181
15.4 VIEWING AND MANAGING LOGS	182
Deleting Logs.....	182
Exporting Logs	182
15.5 MANAGING THE ROBOT SYSTEM CONFIGURATION.....	183
Packaging posture.....	183
Factory reset	184
Use Default Program	184
Exporting the configurations	184
Importing the configurations	185
15.6 SOFTWARE UPDATE.....	187
Cautions during update	187
Updating software	187
APPENDIX A WARRANTY	189
Warranty	189
Warranty period	189
Limitation of Liability.....	189
APPENDIX B CERTIFICATION	190
Safety	190
MD(Machinery Directive).....	191
LVD(Low Voltage Directive).....	192
EMC (Electro Magnetic Compatibility).....	193
APPENDIX C DIMENSIONS FOR INSTALLATION	194
APPENDIX D TOOL FLANGE CROSS SECTION	195
APPENDIX E PORT PIN MAP	196
APPENDIX F SYSTEM SPECIFICATIONS	197
APPENDIX G STOPPING TIME AND DISTANCE	198

Chapter 1 Product Overview

1.1 Collaborative Robot System

Hanwha Precision Machinery's collaborative robot, HCR-3 is a user-friendly robot that provides an automation environment where it can safely collaborate next to humans in various fields.

Easy setting

By using the direct teaching feature and the intuitive S/W GUI, users can easily configure and control the robot.

- While holding the robot gently, users can implement desired movements, so that the robot can detect and memorize movements.
- Users can preview the robot movement in a real time 3D and use the icon based intuitive GUI for easy operation.
- As the installation method is simple, even if users are not robot engineers, they can easily configure the initial setting and program the robot.

Flexible rearrangement

Users can easily rearrange the robot, so that it can be applied to various processes easily and quickly.

- Since users can operate the robot in small space, it is possible to rearrange the robot without changing the layout of the manufacturing line.
- The robot is light weighted and easy to move, and its simple programming environment allows the robot to be easily adapted to high-mix, low-volume production.

Safe collaboration

Using the various safety features, users can safely work next to the robot without using additional safety tools or devices.

- The robot is automatically stopped when it detects an impact, so as long as the working range of the robot and the user are guaranteed, it can be installed anywhere for safe use.

1.2 System Components

The following is a list of system components.

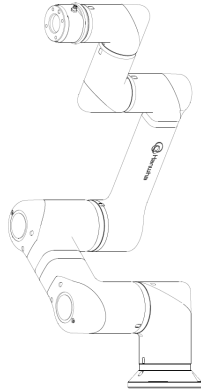

Robot arm

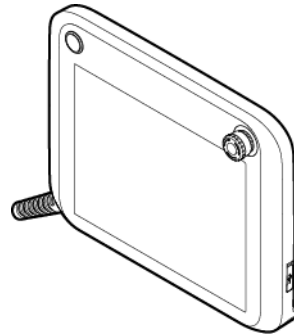

Teaching pendant

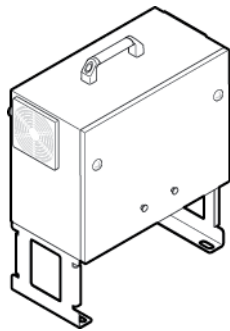

Robot controller

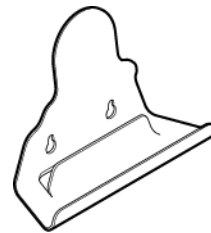

Teaching pendant fixing bracket

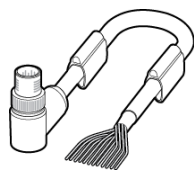

8 pin tool cable

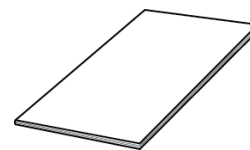

User manual

The following list indicates the quantity of each component.

Robot	Robot arm	1 EA
Controller and teaching pendant	Robot controller	1 EA
	Teaching pendant	1 EA
	Teaching pendant fixing bracket	1 EA
Others	8 pin tool cable	1 EA
	User manual	1 EA

1.3 Basic System Configuration

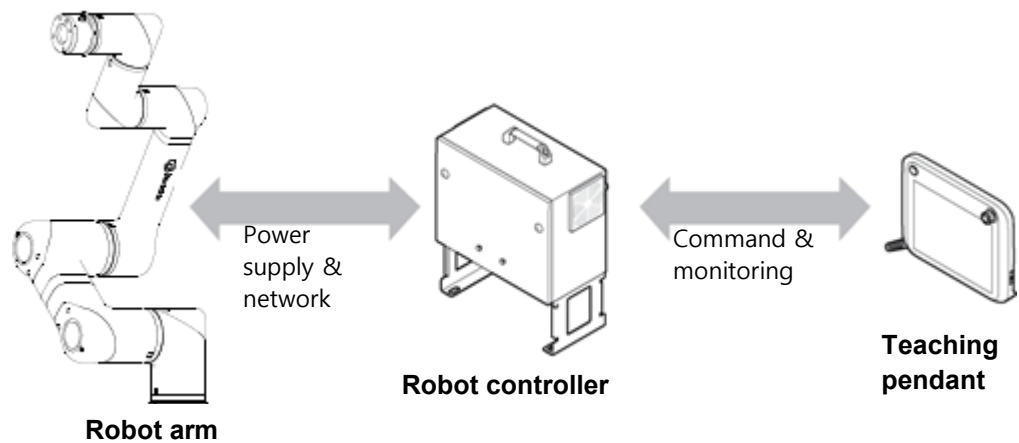

- **Robot arm:** It is an industrial collaborative robot that can be used to convey objects or assemble parts, and it can be used by attaching various tools such as grippers.
- **Robot controller:** Can control the robot arm's various movements according to the program prepared by the user. It can be connected with various devices and equipment through its various I/O ports.
- **Teaching Pendant(TP):** It is a device used for system operation. It can teach the robot a specific position or control and configure the robot in many ways.

1.4 Overview of Robot Arms

Parts and Joints

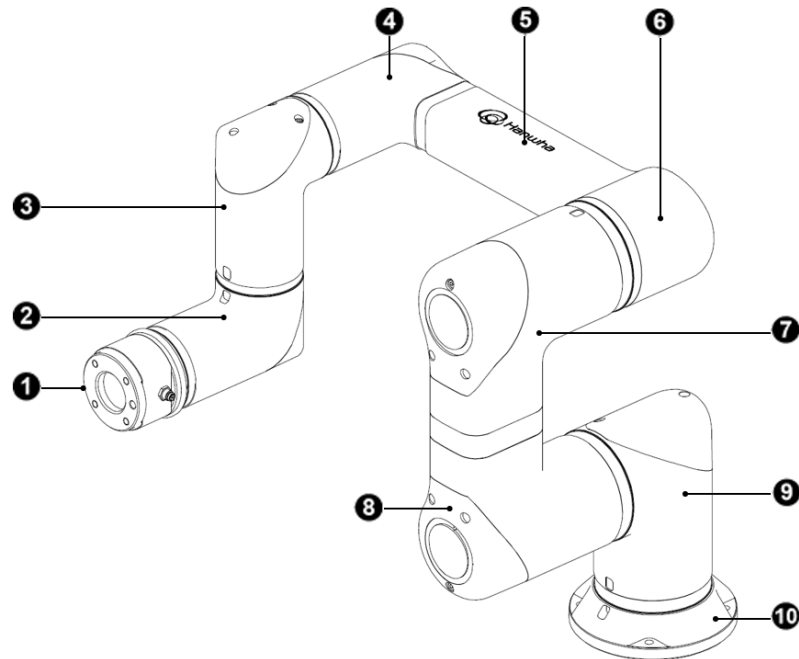

1 Tool Flange

5 Lower Arm

9 J1

2 J6 Wrist3

6 Elbow

10 Base

3 J5 Wrist2

7 J3

4 J4 Wrist1

8 J2 Shoulder

Functions

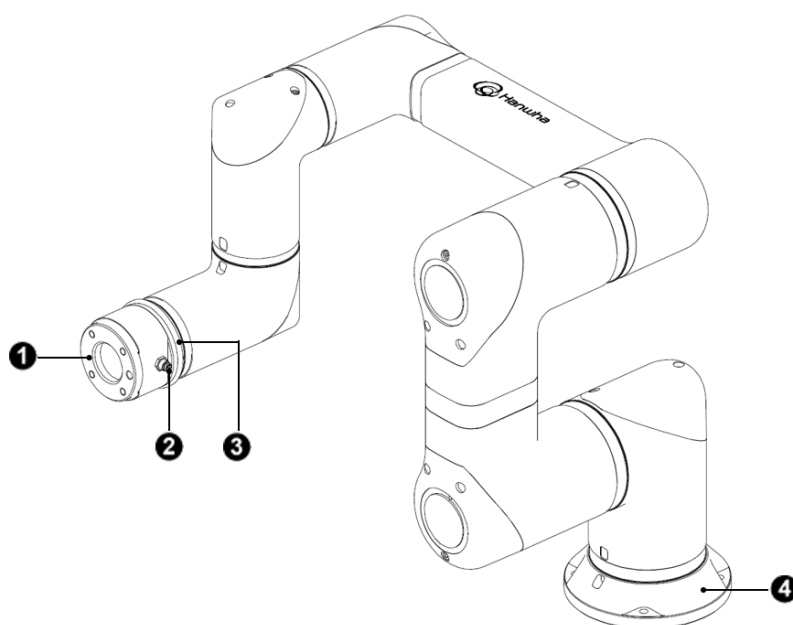

No.	Name	Description
1	Tool flange	It is the area in the robot where a tool is mounted. For more details, refer to 3.4 Connecting Tools to Robots .
2	Tool I/O	It is the I/O port used to control a tool. For more details about specifications, refer to Appendix E Port Pin Map .
3	LED	Indicates the status of robot. <ul style="list-style-type: none"> • Green: Operation mode • Blue: Direct teaching mode • Red: Emergency stop mode • Pink: Exceeding joint range limits in direct teaching
4	Robot base	It is the area in the robot that is fixed to the ground or wall.

1.5 Overview of Robot Controller

Front

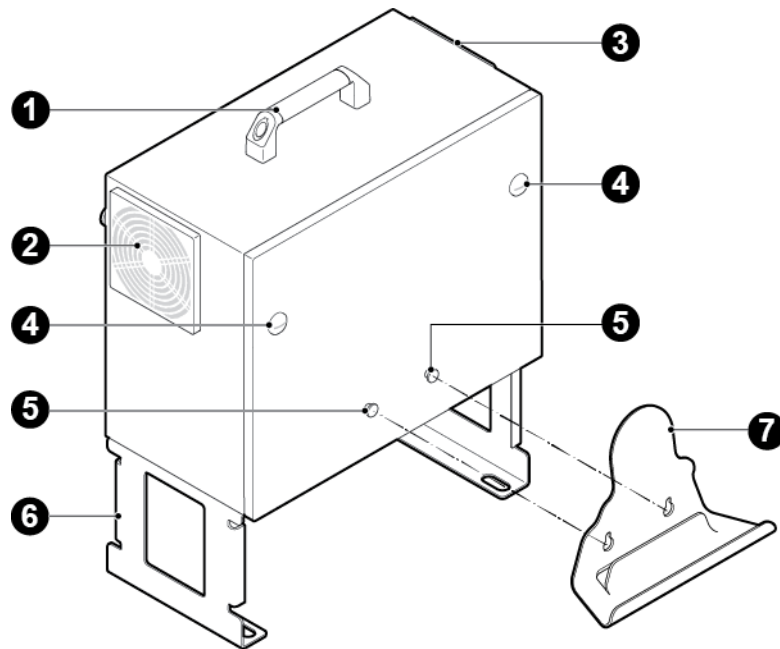

No.	Name
①	Handle
②	Air exhaust hole (exhaust hole filter)
③	Air intake hole (intake hole filter)
④	Controller cover locking screw
⑤	Teaching pendant fixing hook
⑥	Controller fixing bracket
⑦	Teaching pendant fixing bracket

Bottom

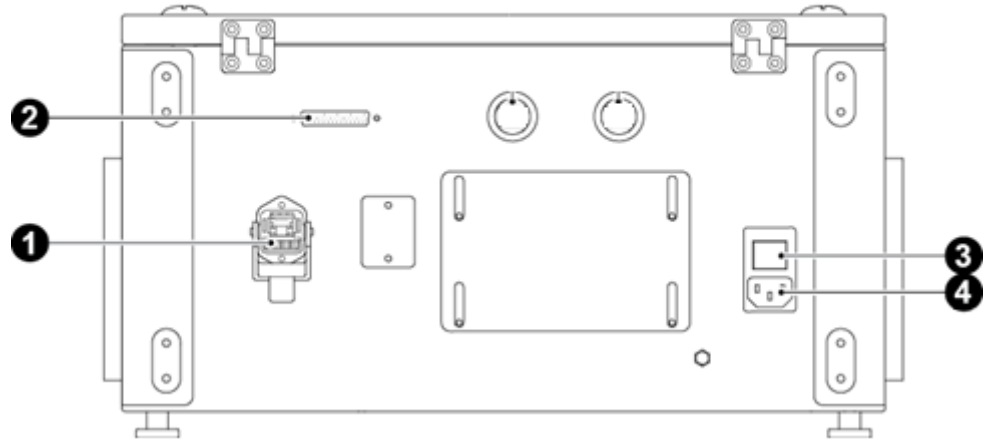

No.	Name
①	Robot connector
②	Teaching pendant connector
③	Power button
④	AC power socket

1.6 Overview of Teaching Pendant

Front

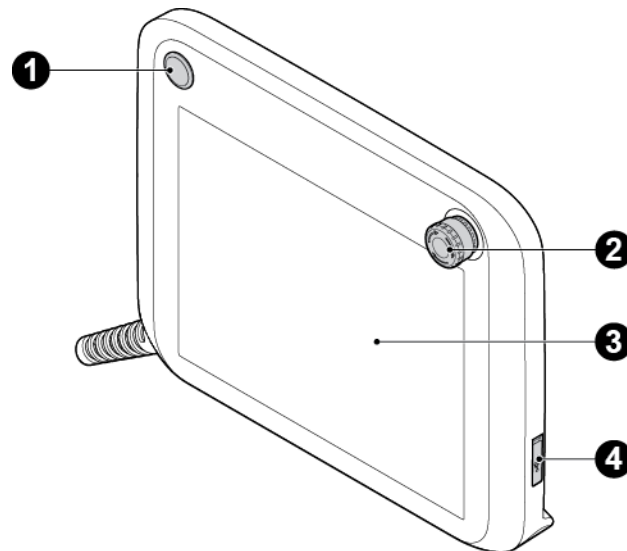

No.	Name	Description
1	Power button	Turn on/off the power of the teaching pendant. For more details, refer to 4.2 Turning on the Teaching Pendant .
2	Emergency stop button	Press it to stop the robot. For more details, refer to 2.7 Emergency Stop .
3	Touch screen	A resistive touch screen that detects a touch even if user wears a glove.
4	USB port	USB 2.0 port that can be used by plugging in a USB memory, keyboard, mouse, etc. ¹

¹Some devices may not be compatible with the teaching pendant.

Rear

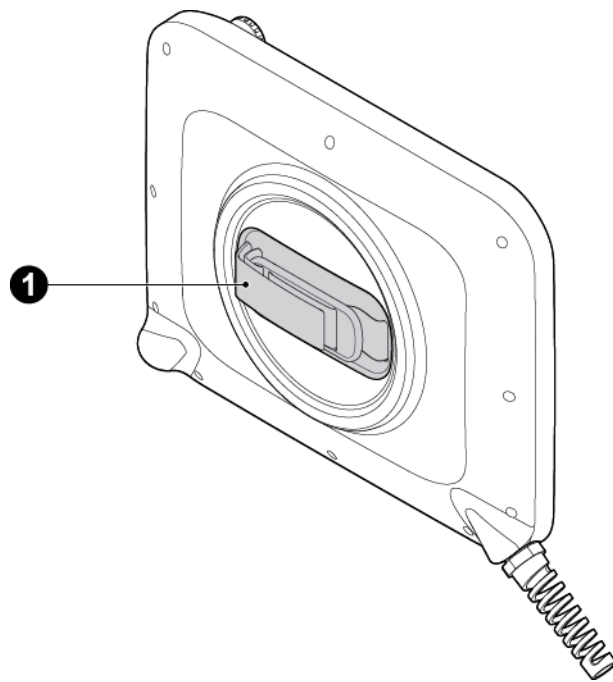

No.	Name	Description
1	Handle	Users can insert their hands and lift the teaching pendant for use. Users can turn the handle and insert their hand in the desired direction.

1.7 Axial Coordinates and Operational Range

It consists of a total of six axes and an axis of each joint has the following coordinates and operational ranges. The direction of arrow indicates the (+) rotational angle and the opposite direction of arrow indicates the (-) rotational angle.

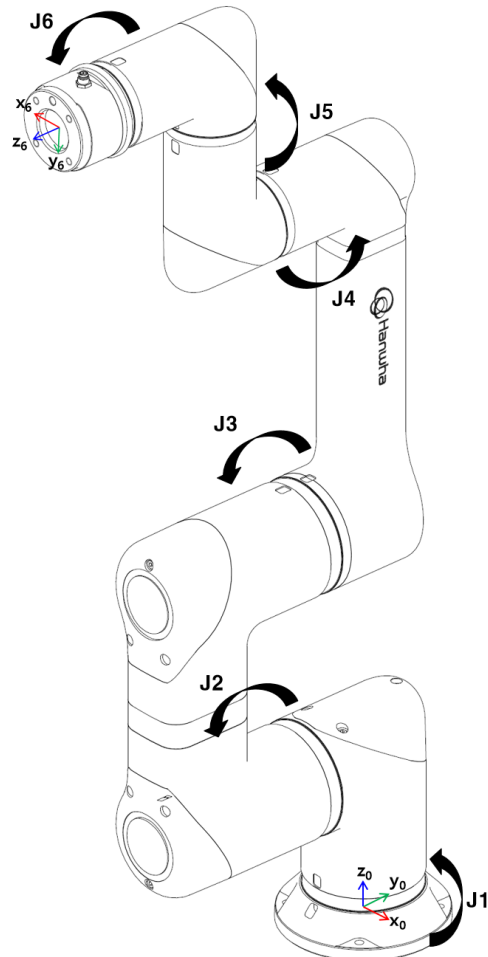

Operational axis	Operational range
J1 axis	$-360^\circ < rz_1 \leq +360^\circ$
J2 axis	$-360^\circ < rz_2 \leq +360^\circ$
J3 axis	$-160^\circ < rz_3 \leq +160^\circ$
J4 axis	$-360^\circ < rz_4 \leq +360^\circ$
J5 axis	$-360^\circ < rz_5 \leq +360^\circ$
J6 axis	$-\text{infinite} < rz_6 \leq +\text{infinite}$

Note The J3 axis has a limited operational range due to its unique structure.

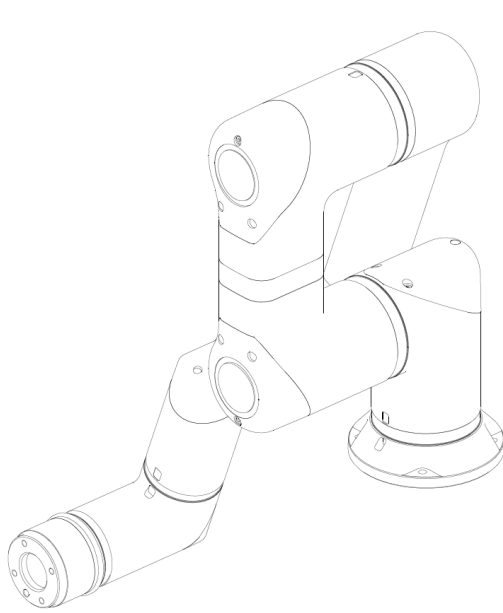

When the J3 axis is at +160°

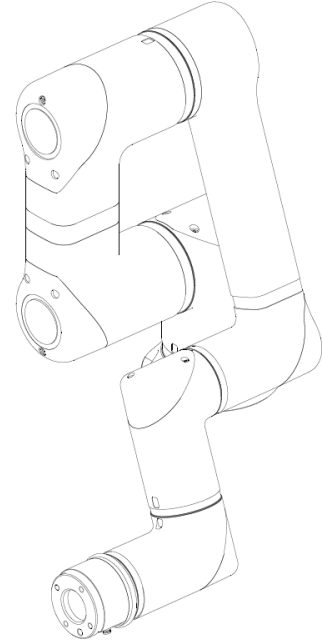

When the J3 axis is at -160°

1.8 Robot's Working Range

The radius of rotation for the robot when its arm is fully stretched is 630 mm. The radius of 74.3 mm from the center axis of the base is the area where the robot arm cannot reach due to its structure.

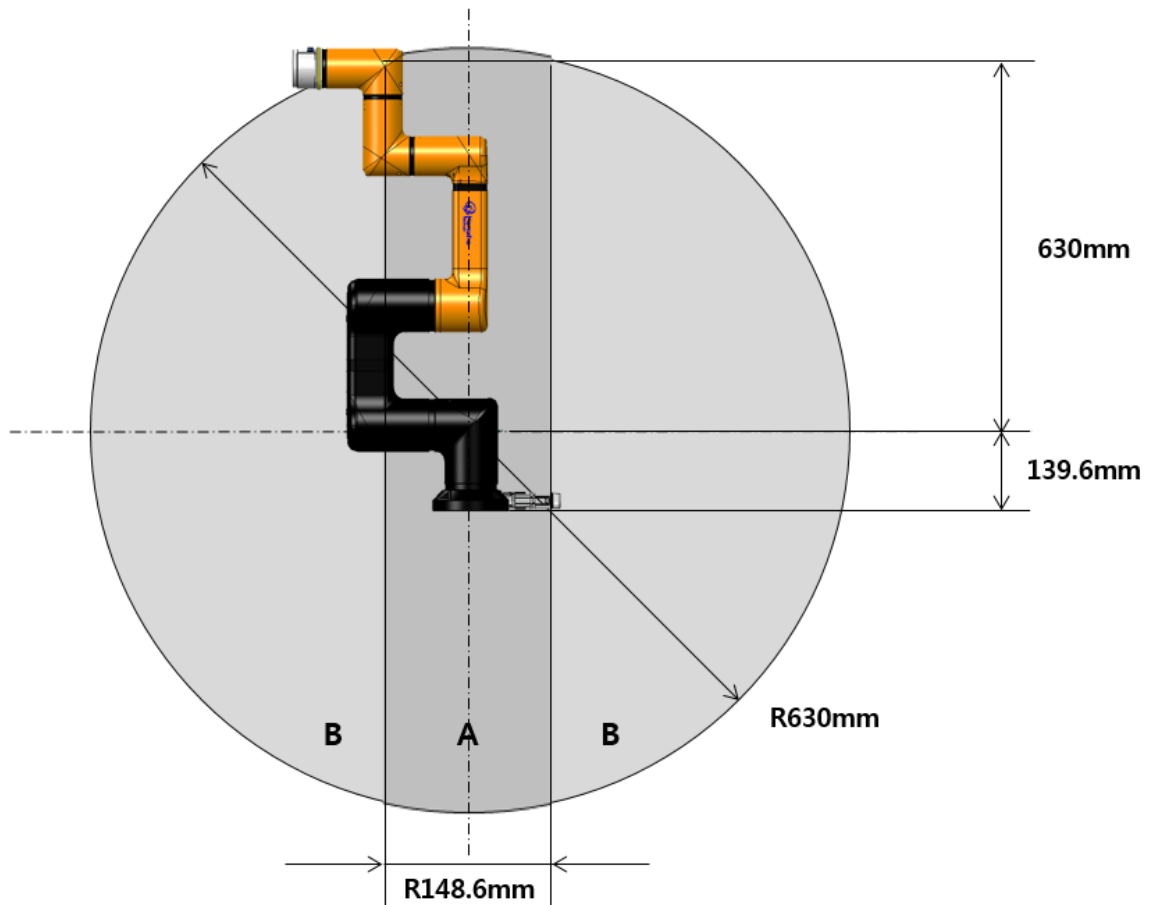

- A: Working range where the robot arm cannot reach
- B: Working range where the robot arm can reach

1.9 Maximum load capacity for the tool

The load capacity of the robot arm may vary depending on the distance between the tool flange and the payload's center of gravity. The load capacity per distance is as follows:

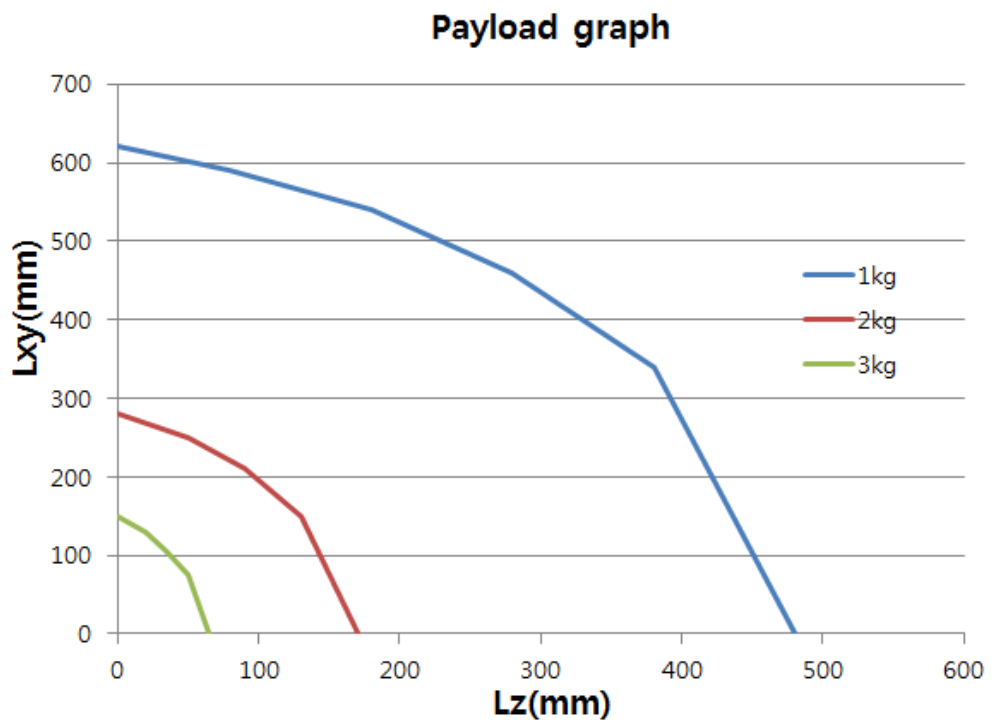
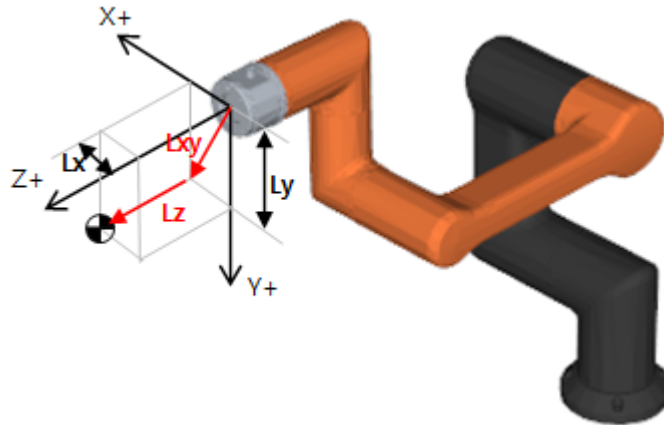

Chapter 2 Safety

2.1 Safety Marks in the User Manual

The user manual contains the following safety marks.

Danger

If a user does not obey the safety mark, then it can cause a severe accident including death or serious injury of a user.

Warning

If a user does not obey the safety mark, then it can cause an accident including serious injury of a user.

Caution

If a user does not obey the safety mark, then it can cause a damage to the product or injury of a user.

2.2 General Safety Cautions

Danger

User needs to install the robot and the electrical equipment by complying with the instructions given in Chapter 3 Installation.

Warning

- Robot application system manufacturers and robot users should be familiar with this manual and complete the robot operation training.
- Make sure sufficient space is available so the robot arm can move freely.
- When using the robot, a user should not wear loose clothes or accessories. If you have long hairs, then tie it in the back so that it does not stuck in the robot's joints.
- Do not ever use a damaged robot.
- If a fatal error occurs in the software, then immediately stop it and contact the product supplier.
- Check if values such as the robot installation angle, tool settings and safety settings are correctly inputted.
- Do not connect the safety device to a general I/O. Safety device is used only for safety related I/O.
- When using the teaching pendant, pay close attention to the robot's movements.
- When the robot is operating, do not enter the working range of the robot or touch the robot.
- Do not modify the robot on your own. If a user causes a problem by modifying or remodeling the product on their own, then Hanwha Precision Machinery will not be responsible for it in any sort of way.
- The robot and the controller can generate heat after long hours of use. Do not touch the robot after long hours of use. If you need to touch the robot, then power off the controller and cool down the robot first.
- When the robot collides with an external object, a significant level of kinetic energy is generated, which is proportional to the speed and the payload. (Kinetic energy = $1/2 \times \text{mass} \times \text{speed}^2$)
- Regarding the robot installation, make sure to use a proper configuration for installation. If robot mounting, tool weight, tool's center of gravity, tool length, safety configuration, etc. are not correctly entered, the direct teaching or collision detection function may not work properly.

- You should use the direct teaching function in a safe environment. DO NOT use it if there is a sharp part or cause of jamming in a tool or surrounding installations.
- Correctly enter tool related information (the length, weight, center of gravity of the tool, etc.) before using the direct teaching function. If you enter information different from the actual specification of the tool, you may experience malfunction when using the direct teaching function.
- If a joint is operated at the speed beyond a certain limit when using the direct teaching function, it may make an emergency stop for the safety of operators.

 **Caution**

- It is recommended that you test all the functions separately before using the machine or other robot that can damage the robot. If other machine or robot is damaged by programming errors or robot failures, Hanwha Precision Machinery will not be responsible for it.
- Do not expose the robot to a strong magnetic field. Your robot can be damaged.

2.3 Intended Use

This robot may be used for transport, and assembly of objects with tools. However, use it only under the environment specified by its specifications.

Since the safety function is built in, the collaborative work is possible without physical protective fence. However, for the final system applied with robot, the risk assessment should be conducted on the whole system before use.

The system integrator or the end user who implements the robot applied final system shall take the responsibilities as follows:

(These are examples and are not limited to them.)

- Use in potentially explosive environment.
- Medical applications and human life related applications
- Use in human and animal transportation
- Use without the risk assessment
- Use in places where the performance of the safety function is not sufficient
- Use beyond its performance and environmental specifications

2.4 Potential Dangers

If the risk assessment, conducted by the final system manufacturer who applied the robot, concludes that it is not possible to fully reduce the risk only with the built-in safety function, additional protective measures should be established.

Consider potential dangers as follows:

- Injuries that may occur if the human body part such as finger is caught in the robot joints (confinement).
- Injuries caused by sharp edges or corners of tools (stab or penetration)
- Injuries caused by objects around the robot (stab, penetration, or falling)
- Injuries that may occur when working on toxic or hazardous materials (skin damage or dyspnea)
- Injuries caused by collisions with the robot (bruise or fracture)
- Injuries caused by loosely coupled parts.
- Injuries caused by objects separated or fallen from the tool.

Note Potential dangers that may occur vary depending on the final system.

2.5 Limitation of Liability

This user manual does not cover all of the peripherals affecting the safety. A system installer must comply with the safety requirements according to the safety rules and laws of the country where the robot is installed.

The robot is configured as the final system interconnected with peripherals. This user manual covers neither the design, installation, operation of the final system nor all of the peripherals including the safety device.

The final system which applied the robot shall be designed and installed according to the safety requirements in compliance with laws and regulations of the country where it is installed.

The system integrator or the end user who implements the robot applied final system shall take the responsibilities as follows:

(These are examples and are not limited to them.)

- Risk assessment on the final system

- Addition of safety devices according to the risk assessment results
- To check whether the system is correctly designed, set up and installed
- Definition on how to use the system
- Providing information on operation and safety as well as contact information
- Provision of technical documents including the user manual

Complying with the safety items in the user manual does not mean that all possible risks are prevented.

2.6 Transportation

The weight of the robot arm is 13 kg and that of the controller box is 20.2 kg. A minimum of two people is required for moving it safely.

Carry the controller box by holding the handle at the top.

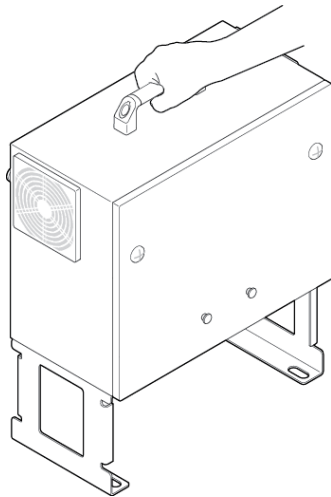

 **Warning**

During transportation, avoid damages caused by falling accidents. The warranty does not cover any damage caused during transportation.

2.7 Emergency Stop

You can press the emergency stop button to immediately stop the robot in case of emergency. The emergency stop button is basically located in the teaching pendant and you can stop the robot by connecting another emergency stop button to the robot controller.

Caution

In the event of a collision or an emergency stop while driving over the speed of 120°/sec, check the zeroing of the robot joint and calibrate it if needed. After that, check if the movement path of the tool set in the operating program is correct. Contact the manufacturer or the service representative if you need the zeroing adjustment.

Using emergency stop

You can press the emergency stop button in the teaching pendant to immediately stop the robot.

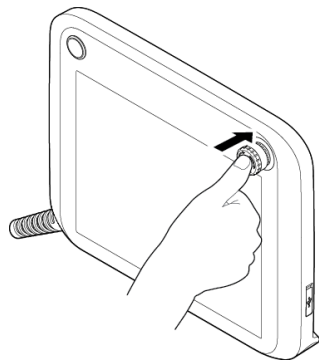

Cancelling emergency stop

Turn the emergency stop button clockwise to cancel emergency stop.

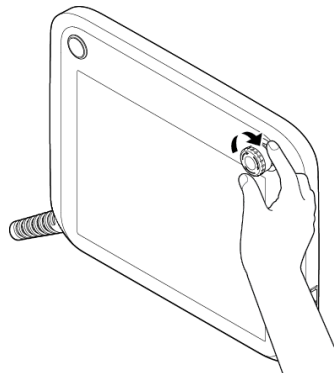

2.8 Safety Fence

Unlike other kinds of industrial robots that adopt physical fences, virtual fences are implemented to make sure that the TCP does not reach out of certain limits. For more details, refer to [0](#)

Setting Safety Boundaries.

2.9 Limits of Speed and Rotational Angles

By limiting the rotational angle and speed of each joint, you can secure your safety. For more details, refer to [8.1 Limiting Robot Movement](#).

2.10 Operating Robots without Driving Power

In case of emergency, when the robot is not driven by power, an adult can move each axis with their own force.

 **Caution**

If you use excessive force to move the axis when the robot is not being driven by power, it can overload the driving unit. The manufacturer is not responsible for the failure caused by excessive force.

2.11 Safety Controller

The safety controller for HCR-3 complies with the ISO13849 Cat3, PLd class.

2.12 Risk Assessment

The risk assessment is one of the important factors when configuring a robot configured system. The degree of safety regarding robot installation varies depending on the way of integrating it into the entire system, so it is not possible to perform the risk assessment with the robot alone.

The person who configures the robot included system to perform the risk assessment of the robot should install and operate it according to instructions of ISO 12100 and

ISO10218-2 standards. For further information, refer to the Technical Specification ISO/TS15066.

You must perform the risk assessment right after the robot is installed. The main objectives of the risk assessment are to set up safety configuration suitable for the surrounding environment and robot settings and to find out the need for additional emergency stop buttons and protective measures.

It is possible to configure functions related to safety of the collaborative robot from the Safety Configuration Setting menu. Available functions are as follows:

- Joint Rotation Limit: You can limit the angle of each joint.
- Joint Speed Limit: You can limit the speed of each joint.
- TCP Speed Limit: You can limit the max speed for the TCP's linear movement.
- Force Limit: You can limit the maximum force that stops the robot when it detects a collision with a surrounding object.
- Safety Boundary Limit: You can build a virtual fence within the robot working area to prevent robot arms or tools from moving beyond the boundary for the safety of users.
- Redundant I/O Setting: You can set up redundancy to an I/O terminal to input/output important safety-related information.

If dangers are not sufficiently reduced or removed through the safety related functions above, add more protective measures to remove them. The manufacturer is not responsible for accidents caused by noncompliance with relevant requirements of international standards and local laws and regulations in relation to installation or due to not performing review on those requirements during the risk assessment as above.

Chapter 3 Installation

The installer should install and operate the robot according to instructions of ISO 12100 and ISO10218-2 standards and comply with relevant requirements of international standards such as ISO/TS 15066 and local laws and regulations.

The manufacturer is not responsible for accidents caused by noncompliance with relevant requirements of international standards and local laws and regulations or due to not performing review on the risk assessment as mentioned in Section 2.12.

3.1 Installation Locations

It is recommended to install the system in a place which meets conditions as follows:

- A building with earthquake-resistant design
- A place without water leaks
- A place free of flammability or explosives
- A place that maintains the constant temperature and humidity
- A place with little dusts

 **Caution**

If the system is not installed in a recommended place, the performance and the life span of the robot may be reduced.

3.2 Installation Types

You can install the robot arm on ceiling, wall or floor as follows.

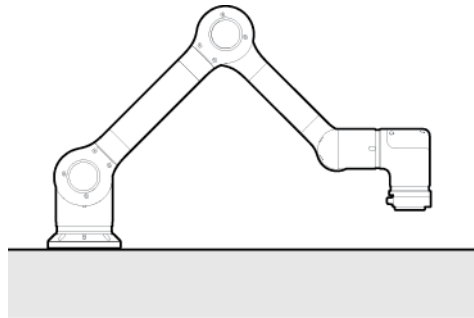

Example of installation on floor

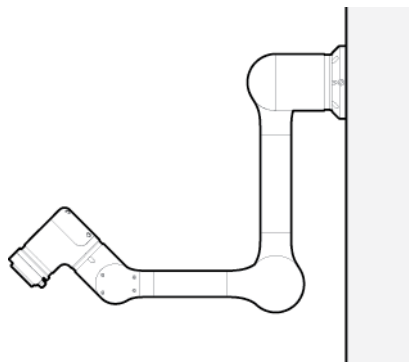

Example of installation on wall

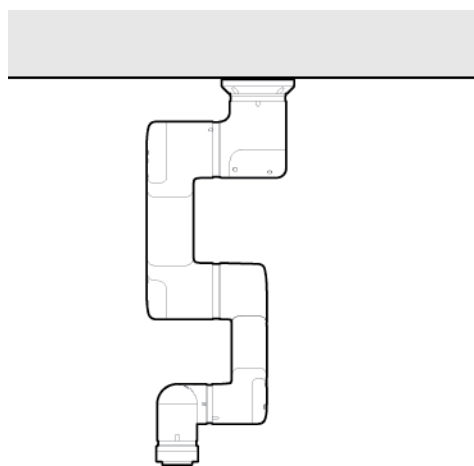

Example of installation on ceiling

You can also install it on a moving dolly or fixed post.

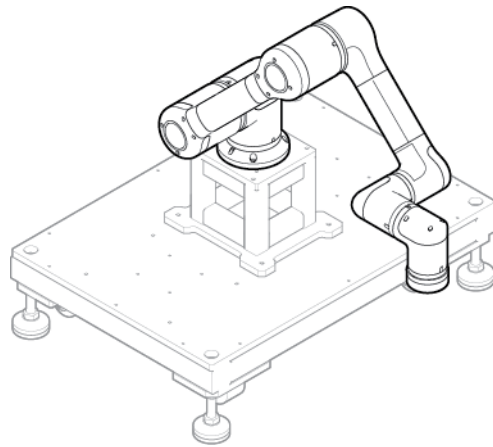

Example of installation on a moving dolly

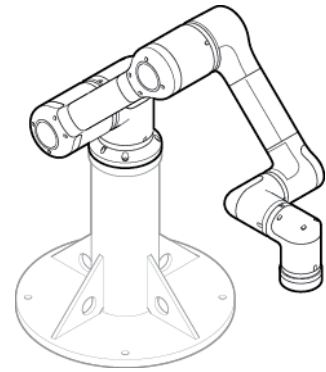

Example of installation on a fixed post

Warning

If you install the robot on a moving dolly, you must make sure the moving dolly is fixed to the ground when operating the robot.

Note The moving dolly or fixed post is not included in the product package.

After installing the robot, you must configure the robot installation information depending on each type of installation. For more details, refer to [7.1 Setting the Robot Installation Angles](#) .

3.3 Fixing Robots

You can install the robot arm on the ceiling, wall or floor by using 4 pieces of M6 bolts not shorter than 15mm and it is recommended to fasten those bolts with 30 Nm torque. If the strength or levelness of the installation ground is not sufficient for supporting the robot arm, then you can use a fixing base for installation. In this case, if you want to install the robot arm in an accurate location, then you can use two $\Phi 5$ location determination pins to determine the location. In addition, to prevent electrostatic charges, you must connect the grounding line using a piece of M4 x 10 mm bolt.

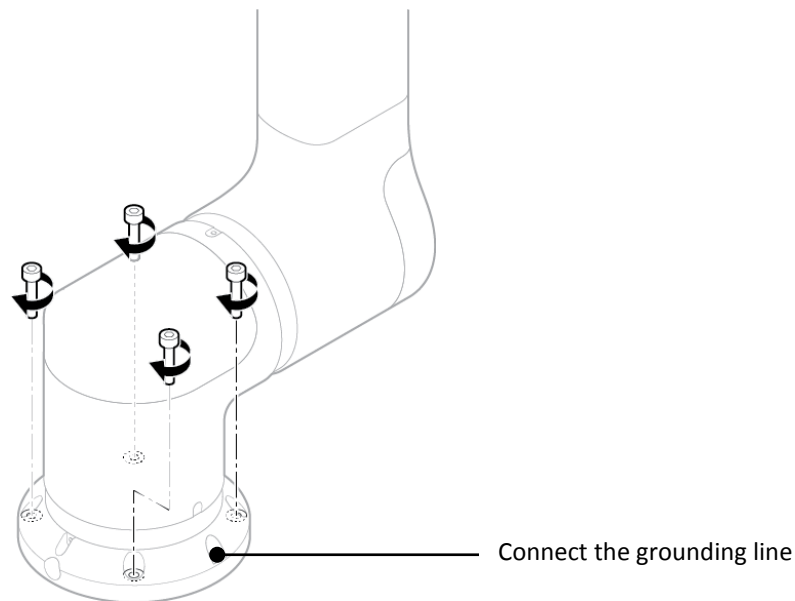

Warning

- When fixing the robot, securely fasten the bolts to prevent them from getting loose.
- Install it on a flat ground that can withstand the robot's weight and the weight that is generated when the robot is operating.
- Check that the installation plane of the robot arm is completely in contact with its base plane.

Note

- The base fixing bolt is not included in the product package.
- For more details about specifications of the robot base, refer to Appendix C Dimensions for Installation.

3.4 Connecting Tools to Robots

- Using four sets of M6 bolts, fix a tool to the tool flange.

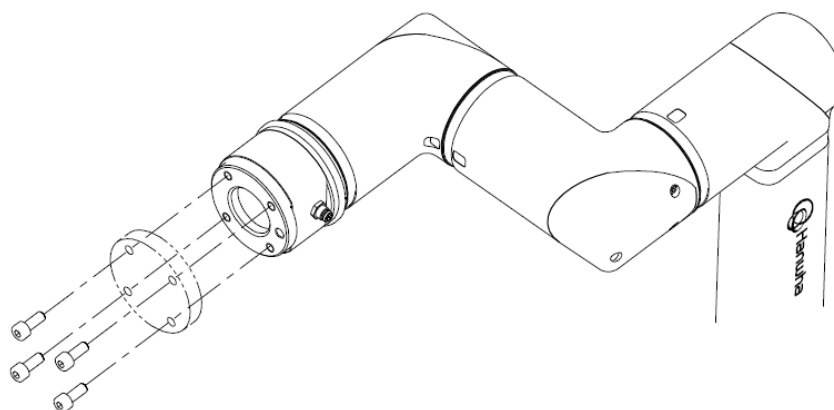

- Note**
- Tools and fixing M6 bolts are not included in the product package.
 - The tool combination method varies from tool to tool. For more detailed methods, refer to the user manual provided by the tool maker.
 - For more details about specifications of tool flange, refer to Appendix D Tool Flange Cross Section.

- After fixing the tool, connect the necessary cables to the tool I/O port.
 - For the tool I/O, you can select one from the analog input (current (0 – 20 mA), voltage (0 – 10 V)), the digital input (2Ch) and the digital output (2Ch, 0, 12, 24 Vdc).

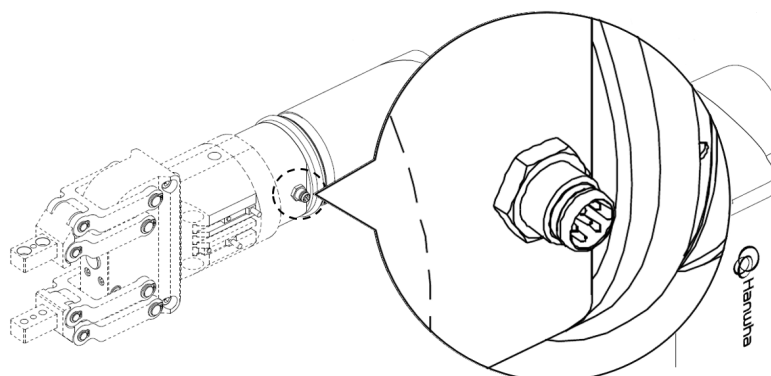

- Note**
- For more details about specifications of the pin maps for the tool I/O, refer to Appendix E Port Pin Map.

3.5 Connecting Cables

Connecting the teaching pendant to the robot controller

After connecting the teaching pendant cable, by using fixing bolts for the connector, securely fasten it, so that the cable does not slip out. Be careful of pin being bended while connecting.

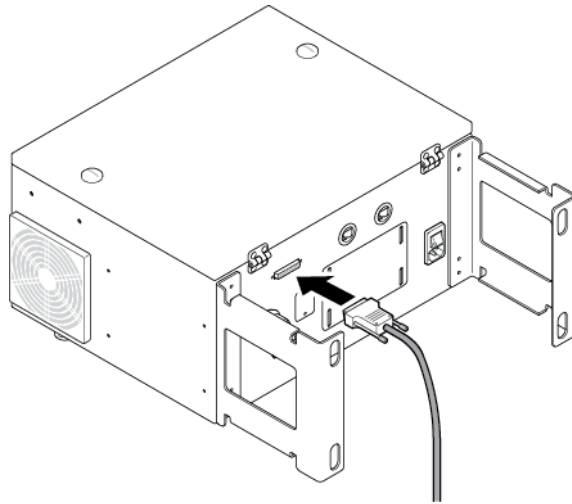

Connecting the robot arm to the robot controller

After connecting the robot arm cable to the robot controller, hook a fixing latch, so that the cable does not slip out.

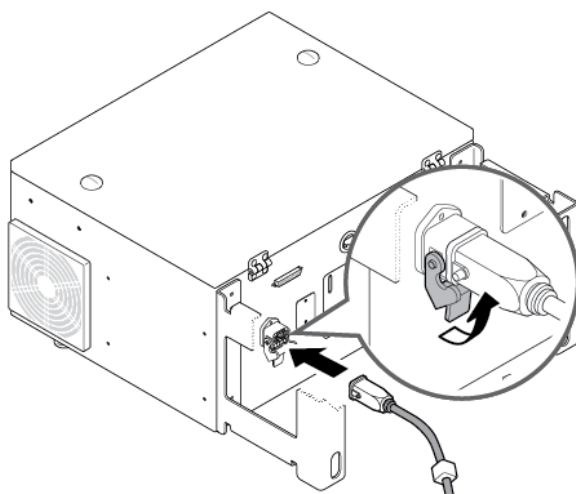

Connecting the power supply to the robot controller

Connect the power cable approved in your country to the power terminal. Robot controller's power terminal accepts standard IEC plugs.

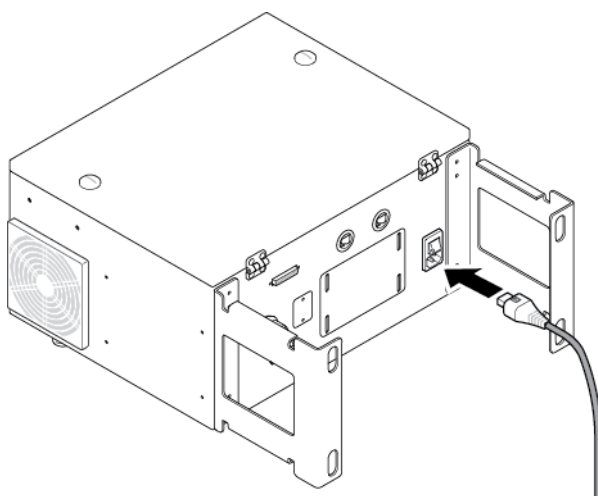

The minimum requirements for power supply are ground, main fuses and circuit breakers, and they should be prepared by the person who prepares for installation.

The following electrical specifications are applicable to power supplies.

Input power	100 ~ 240 VAC
External power supply fuse	8 ~ 16 A (100 ~ 240 V)
Input frequency	47 ~ 63 Hz

! **Caution**

While the robot is on, do not remove the robot connector, the power connector or the teaching pendant connector. When connecting teaching pendant to controller, pay attention to the pin of the connector.

3.6 Fixing the Controller Box

The controller box can be fixed to the ground by using the fixing bracket at the bottom. Fix it with M14 bolts not shorter than 45 mm in combination with flat washers.

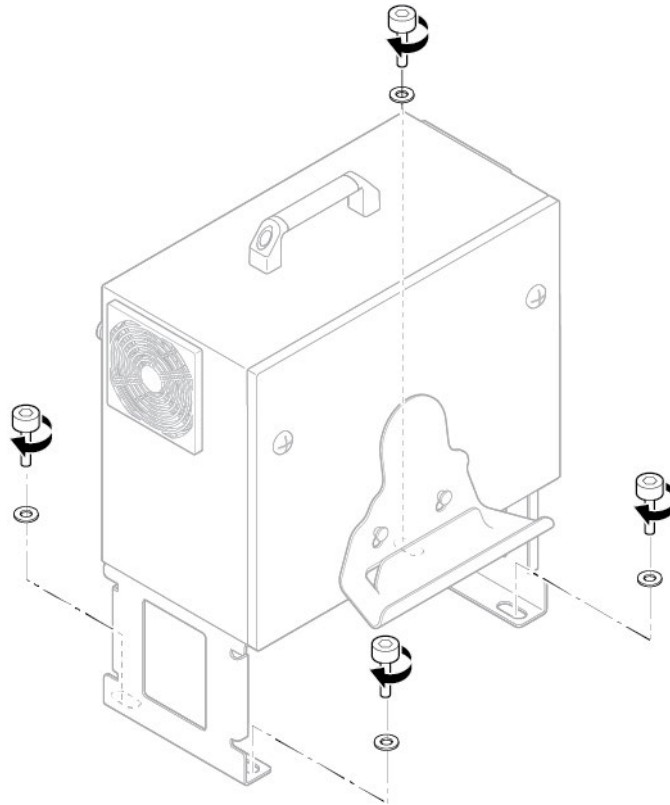

Note Bolts or screws fixing the controller box are not included in the product package.

3.7 Overview of Controller I/O

If you want to connect other external equipment to your controller, then you must first connect it to the I/O inside the controller box. The controller I/O is very flexible, so it can be connected to various equipment such as relays, PLC, and emergency stop buttons.

The following electrical interface layout exists for the area inside the controller box.

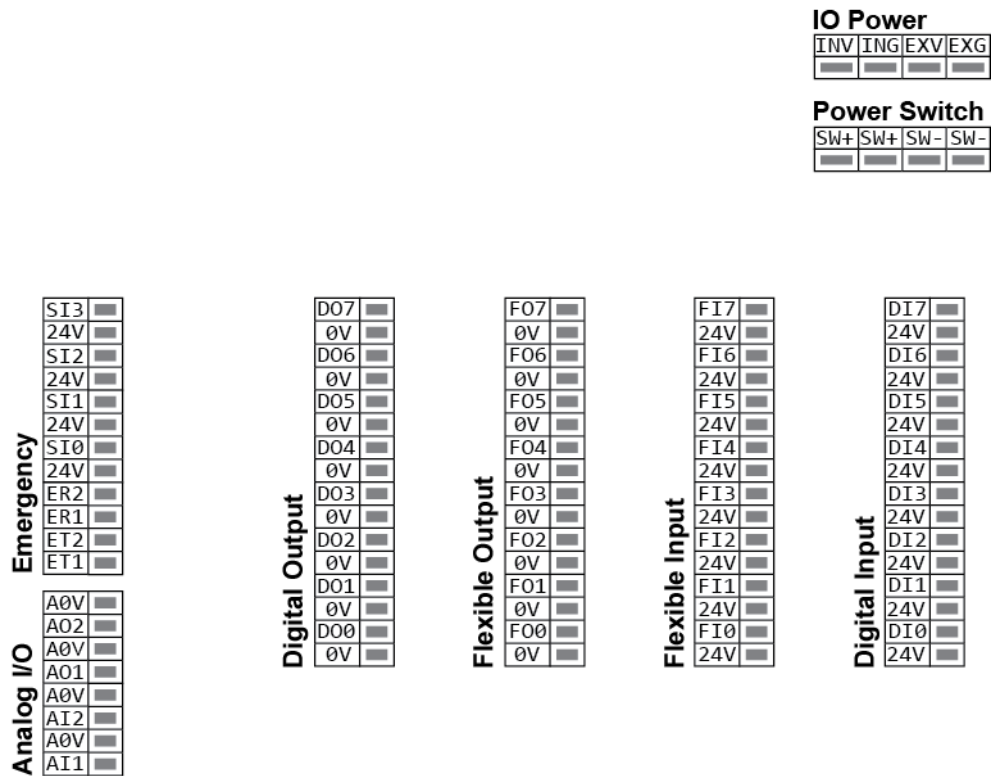

3.8 Common Spec for Digital I/O

The section defines the electrical specifications of the following 24V digital I/O for the controller box.

- Safety Input: 4 EA
- Flexible I/O: Input 8 EA, Output 8 EA
- General I/O (Digital I/O): Input 8 EA, Output 8 EA

By implementing the terminal block called IO Power (J8), you can supply power to the digital I/O from an internal 24V power supply or external power supply. The left two blocks are composed of internal 24V(INT_24V), GND and the right two blocks are composed of external 24V(EXT_24V), GND. They can supply power from the outside to the digital I/O.

Basically, internal 24V power is supplied for use. The basic power supply configuration is as follows.

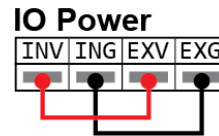

INV	Internal 24 V I/O power supply	Current limit: 2 A
ING	Internal 24 V I/O GND	Typ. DC 24 V
EXV	External 24 V I/O power supply	Min. DC 23 V
EXG	External 24 V I/O GND	Max. DC 26 V

If the digital I/O power supply provided from the inside of the controller is not sufficient, then you can connect an additional power supply externally. If an internal/external power supply is used, then the current limit of 2A is applied.

If the digital I/O requires more current, then you can connect an external power supply as follows.

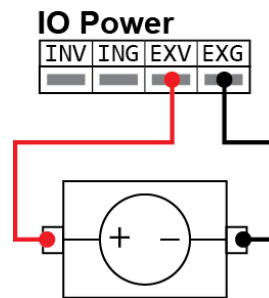

Note If the current is over the upper limit, then the digital I/O fuse can blow off. If the fuse is blown off, you need to replace it.

You can configure the terminal block called as Power Switch (J9) to use it as an external power supply switch.

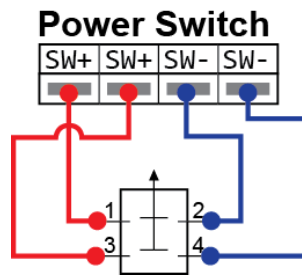

SW+	Push Button Input
SW+	Push Button Input
SW-	GND
SW-	GND

The following electrical specifications apply to the internal or external power supply.

Terminal	Parameter	Minimum	Format	Maximum	Unit
Internal 24V power supply					
INT - ING	Voltage	23	24	25	V
	Current	0	-	2	A
External 24V requirements					
EXV - EXG	Voltage	20	24	29	V
	Current	0	-	2	A

The digital I/O is manufactured by complying with the IEC 61131-2 standard. The following electrical specifications apply.

Terminal	Parameter	Minimum	Format	Maximum	Unit
Digital output					
FOx / DOx	Current	0	-	0.2	A
FOx / DOx	Voltage drop	0	-	0.5	V
FOx / DOx	Leakage current	0	-	0.1	mA
FOx / DOx	Functions	-	PNP	-	Format
FOx / DOx	IEC 61131-2	-	1A	-	Format

Terminal	Parameter	Minimum	Format	Maximum	Unit
Digital input					
EIx/Slx/Flx/DIx	Voltage		–		V
EIx/Slx/Flx/DIx	OFF area		–		V
EIx/Slx/Flx/DIx	ON area		–		V
EIx/Slx/Flx/DIx	Current (11–30V)		–		mV
EIx/Slx/Flx/DIx	Functions	–	PNP	–	Format
EIx/Slx/Flx/DIx	IEC 61131–2	–	3	–	Format

3.9 Configuring the Safety Input

Since a single signal loss should not lead to a loss of the safety function, all the I/O's related to the safety should be duplexed.

Safety Input should always comply with the common specs of the digital I/O.

When you install the safety device or equipment, you should comply with the instructions from Chapter 2 Safety and Chapter 3 Installation.

Safety inputs include emergency stop and safety protection stop. Emergency stop input is for emergency stopping of the robot and safety protection stop input is for protection of all the safety classes. Their functions are different from each other in this sense.

	Emergency Stop	Safety protection stop
Robot stops the movement	Example	Example
Run the program	Stop	Pause
Robot power	Off	On
Initialization	Manual	Auto or manual
Frequency of use	Low	Mid
Re-initialization required	Break release only	No
Stop category (IEC 60204)	1	2
Performance level (ISO 13849–1)	PLd	PLd

Using the Flexible I/O, you can set the Safety I/O additionally. For example, you can use the emergency stop output. In addition, you can configure the Flexible I/O for the safety function in the GUI.

⚠ Danger

Do not connect safety signals to normal PLCs. Only safety PLCs must be connected to safety signals. If you do not comply with the warning, then the safety stop function may fail, causing severe injury or even death. The safety signal and the general I/O signal should be separated from each other.

⚠ Warning

- All the safety class I/O's are duplexed. By separating the channels, you should make sure the safety function is not initiated by a signal failure.
 - Before installing the robot, you must check the safety functions. In addition, the function should be checked for defects periodically.
-

Initial safety configuration

The safety settings of the robot at the factory are as follows.

- Operation software: Unassigned
- Robot controller(Emergency connector): As shown below

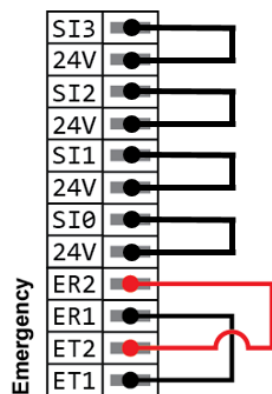

Connecting the emergency stop button

It is recommended that you connect one or more emergency stop button. The emergency stop button is composed as follows.

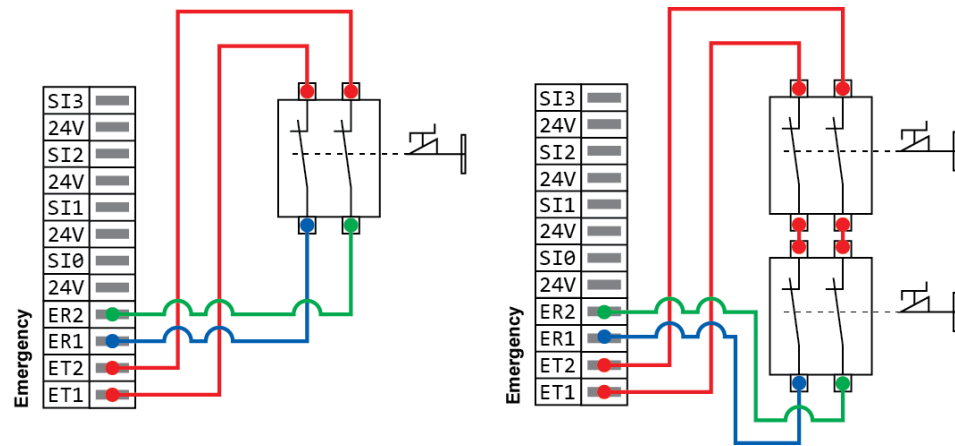

Safety protection stop and restart

As an example of basic safety protection device, basically, when the door opens, you can press the door switch to stop the robot. You can configure the function as follows.

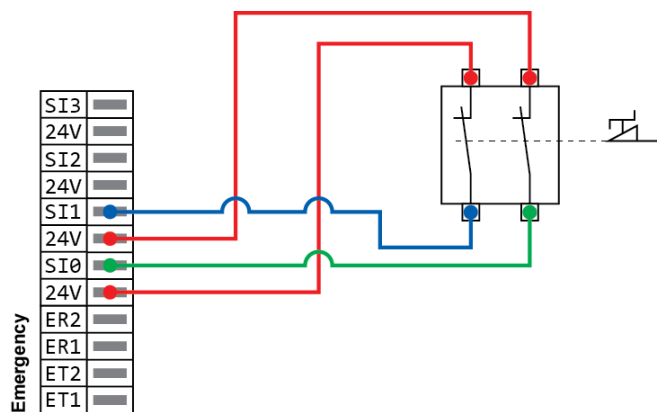

If you cannot close the door after a worker passed through it, then you can use the following features. As another way to resume robot operation, you can use the safety mat or the safety class laser scanner.

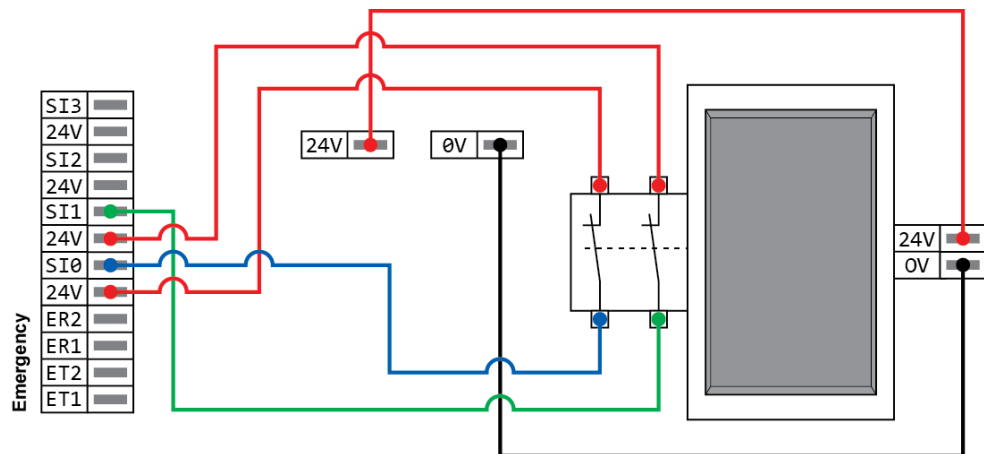

3.10 Configuring the General Digital I/O

If not used as a safety function, then you can use the Flexible I/O as a general purpose digital I/O.

The general digital I/O should comply with the common specifications of digital I/O.

The general digital I/O can be used to configure relays or PLC systems. In this configuration, if the program is not running, the output is maintained low at all times.

Load control with digital outputs

You can control loads with digital outputs. You can configure it as follows.

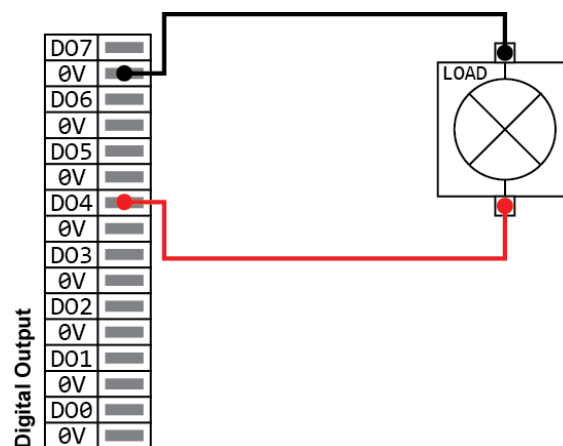

Digital input control using buttons

You can connect a simple button to a digital input. You can configure it as follows.

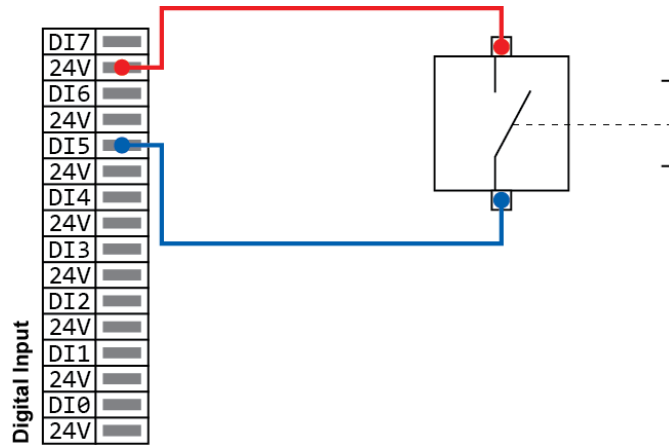

Communicating with other equipment or PLC

The digital I/O can be configured to communicate with other equipment if a common GND is established and if the equipment uses PNP technology. You can configure it as follows.

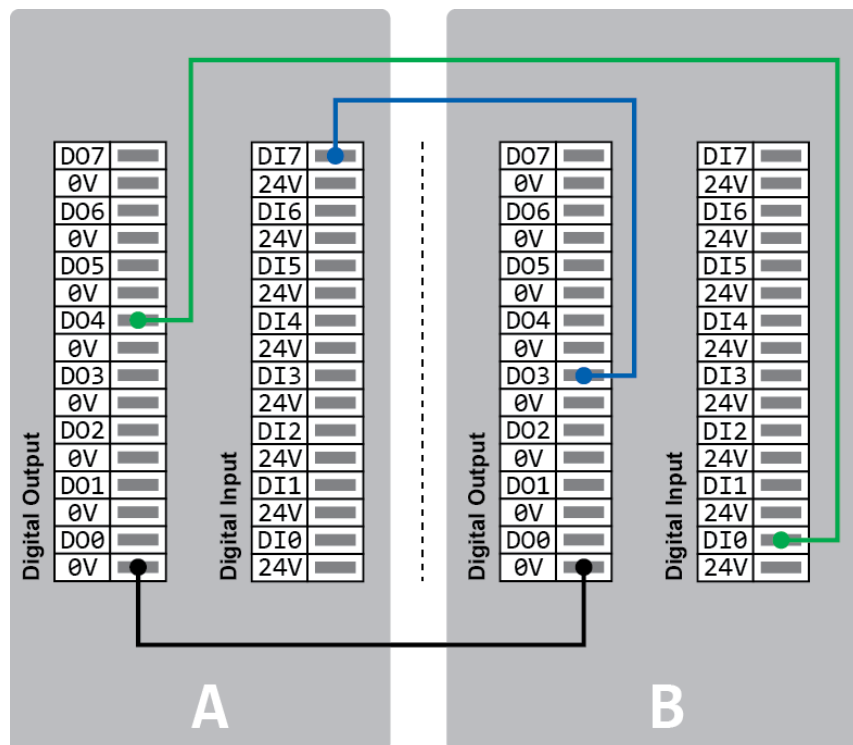

3.11 Configuring the General Analog I/O

It can be used to set or measure voltage (0–10V) or current (4–20mA) between two equipment.

For high reliability, it is recommended that you use the following method.

- Use the analog ground closes to the I/O.
- Equipment and control box should share the same ground. Analog I/O is not insulated in the control box.
- Use the cable that is shielded or twist paired. Connect it to the ground shield of the power (J12) terminal.
- The current signal is not sensitive to noise, so simply use an equipment operating in current mode.

The input mode can be set in the GUI. The following electrical specifications apply to the I/O.

Terminal	Parameter	Minimum	Format	Maximum	Unit
Current mode input					
AIx – AG	Current	4	–	20	mA
AIx – AG	Resistance	–	20	–	Ohm
AIx – AG	Resolution	–	12	–	Beat
Voltage mode input					
AIx – AG	Current	0	–	10	V
AIx – AG	Resistance	–	12	–	Kohm
AIx – AG	Resolution	–	12	–	Beat
Current mode output					
AOx – AG	Current	4	–	20	mA
AOx – AG	Resistance	0	–	10	V
AOx – AG	Resolution	–	12	–	Beat
Voltage mode output					
AOx – AG	Voltage	0	–	10	V
AOx – AG	Current	–20	–	20	mA
AOx – AG	Resistance	–	1	–	ohm
AOx – AG	Resolution	–	12	–	Beat

Analog output

You can use analog outputs as speed control inputs to the conveyor belt. You can configure it as follows.

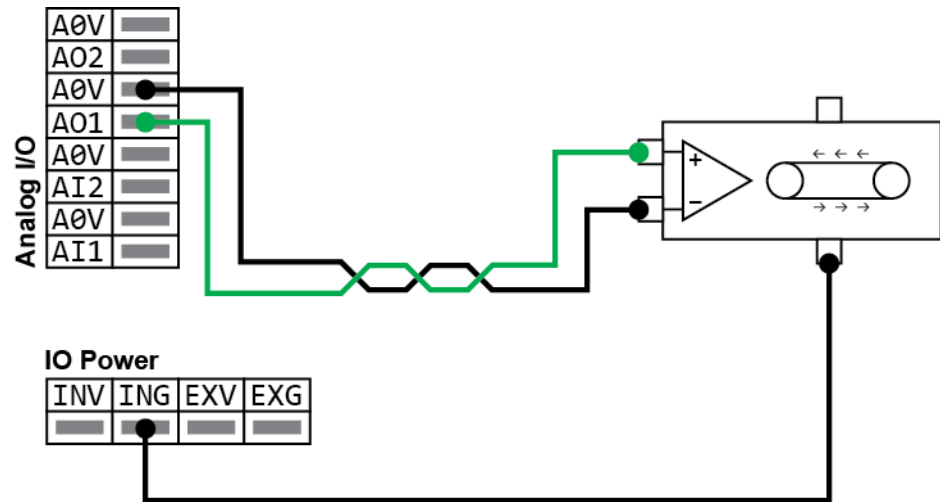

Analog Input

You can use analog sensor outputs as analog inputs. You can configure it as follows.

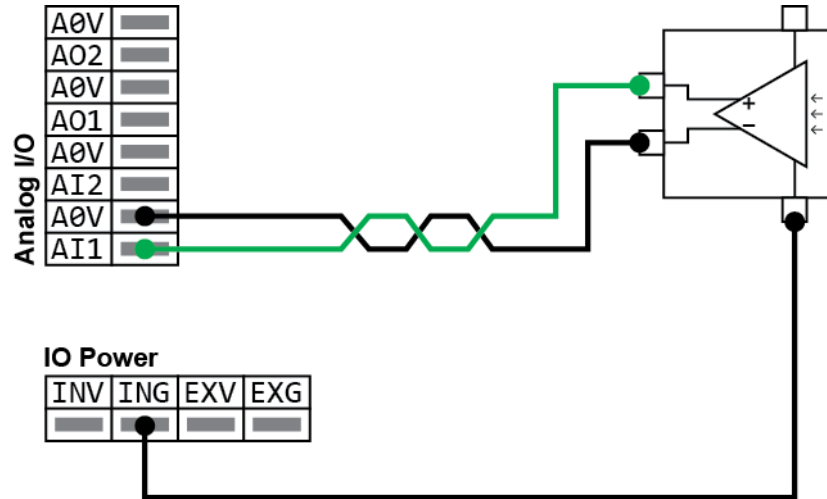

Chapter 4 Getting Started

4.1 Turning on the Robot Controller

Turn on the power switch at the bottom of the controller. If you turn on the power switch for the controller, power will be supplied to the controller.

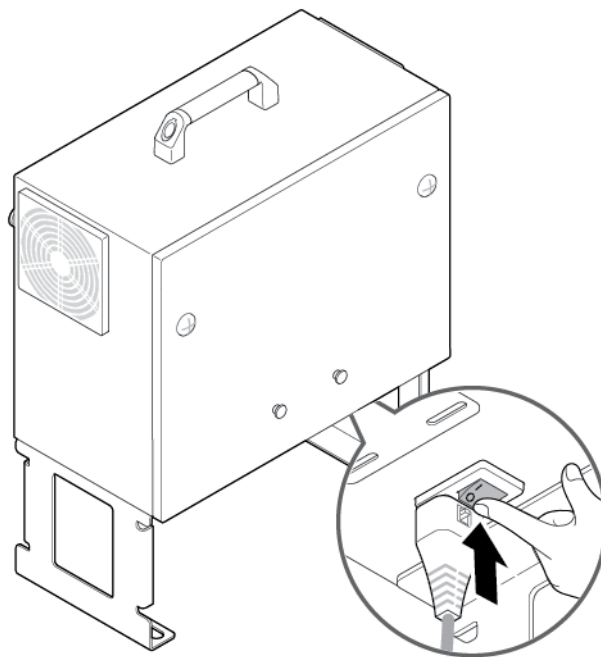

4.2 Turning on the Teaching Pendant

Turn on the power button at the left top of the teaching pendant.

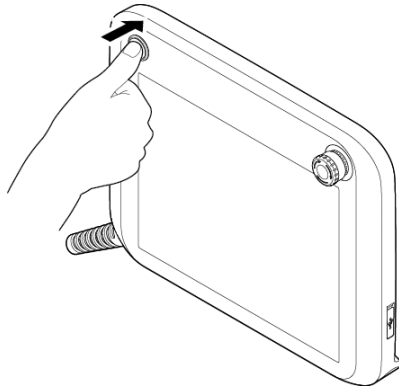

Caution

- Do not turn on the teaching pendant with USB devices connected. It may cause problems with starting the system. Connect it after the system is booted completely.
 - Do not unnecessarily touch the screen while booting the system. It may cause problems with starting the system.
-

Chapter 5 Software Overview

5.1 Menu Overview

Expanding menu



Press the expanding menu button at the left top of the screen to expand the menu. You can check the name of each menu and if a sub menu exists, then you can select it as well.

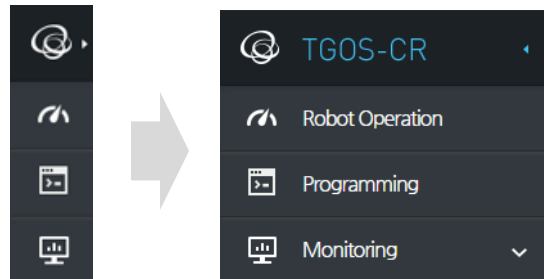

Robot Operation



You can configure basic operation / control (start, pause) of your robot. For more details, refer to [Chapter 10 Starting the Robot](#).

Programming



You can configure the robot's movements. For more details, refer to [Chapter 9 Programming](#).

Monitoring



You can check the real time condition of the robot arm.
For more details, refer to [Chapter 11 Monitoring](#) .

Robot Setting



You can configure the installation information before operating the robot. For more details, refer to [Chapter 7 Setting Robots](#).

Safety Setting



You can configure the safety items before operating the robot safely.
For more details, refer to [Chapter 8 Safety Settings](#).

Device Setting



You can configure an external equipment that will be linked to the robot.
For more details, refer to [Chapter 12 Linking with External Equipment](#).

Management



You can register a robot or user and manage logs, etc.
For more details, refer to [Chapter 6 Registering Robots and Users](#), [15.4 Viewing and Managing Logs](#) & [15.5 Managing the Robot System Configuration](#) .

SW Configuration



You can configure the operation software environment.
For more details, refer to [Chapter 13 Environment Setting](#).

Message



You can select whether or not to display the message window that shows messages that have been set while the robot program is running.

Manual Move



You can control the robot manually.
For more details, refer to [5.3 Manual Move Scree](#).





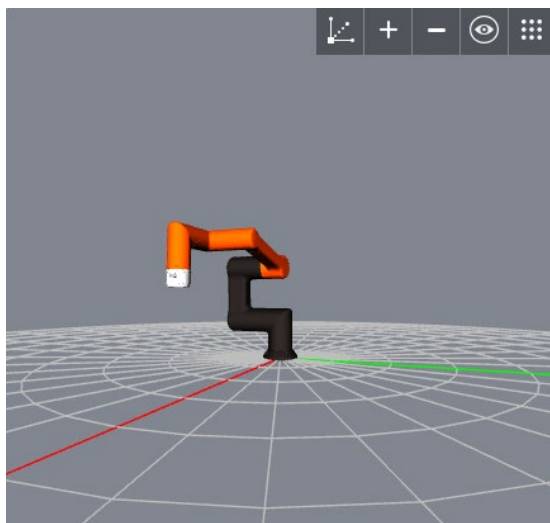

5.2 3D Preview Screen

The system provides a screen where you can preview the robot's movement or coordinates in 3D. You can drag on the screen in the desired direction to change the screen perspectives.



Screen display setting button

You can configure the information displayed on the preview screen and the screen layout.

Basic setting button	
	Hide or unhide the TCP coordinates.
	Initialize the size of the preview screen.
	Decrease the size of the preview screen. (Level 10)
	Increase the size of the preview screen. (Level 10)
	Unhide the additional setting button.
	Hide the additional setting button.

Additional setting button



Hide or unhide the point of the movement path for the tool currently programmed.



Hide or unhide the location/direction of the TCP currently set for the robot.



Hide or unhide the movement path currently programmed.



Hide or unhide the safety borders currently set for the robot.

Note

Depending on the purpose of the menu, some buttons are not available in the preview screen.

Robot task control button

You can preview the programmed robot tasks.



Start the program from the beginning or at the selected task.
When you press the Start button, it changes to the Pause button.



Pause the running program.
When you press the Pause button, it changes to the Start button again.



Execute the unit command that are currently selected.
When done, it is automatically selected with the next command.



Terminate an ongoing task.

Note

Depending on the purpose of the menu, some buttons are not available in the preview screen.

5.3 Manual Move Screen

On this screen, you can control the robot's positions. By using jog control or direct teaching, you can control the robot's position.

Press the  **Manual Move** button in the main menu.

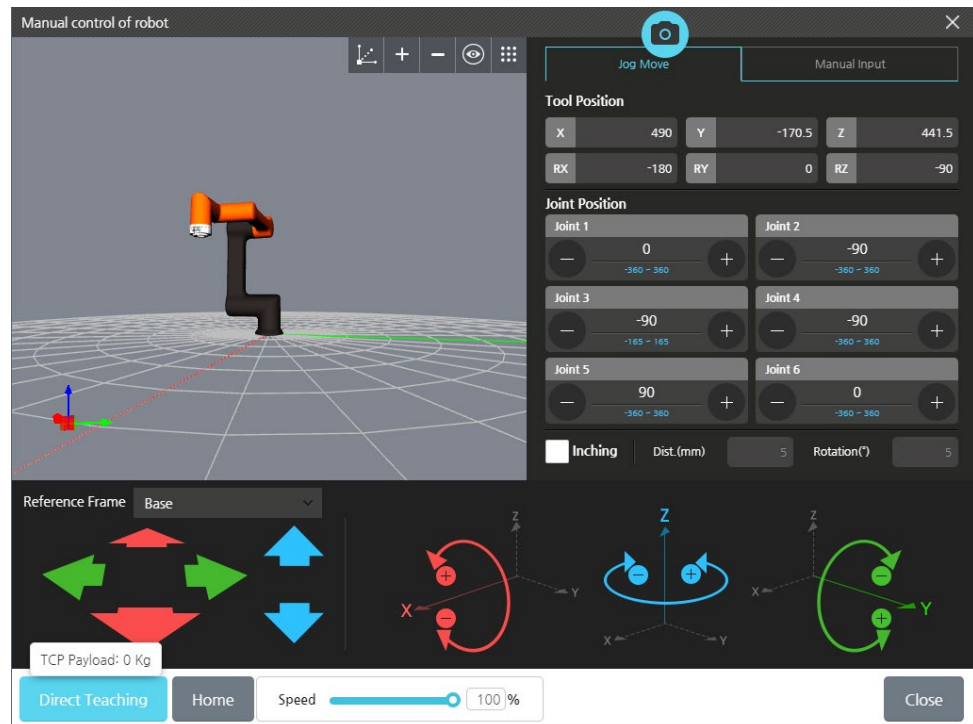

- **Coordinate System** : Selects Coordinate System for manual move. (View, Base, TCP)
- **Tool Position**: Displays the coordinates of TCP.
- **Joint Position**: Displays the angle of the joints. You can modify it by entering a specific angle.
- **Rotation**: Rotates the TCP by using jog buttons.
- **Direct Teaching**: If you manually adjust the robotic arm as you press this button, the system detects any changes in the joint position. When the **Manual Control of Robot** screen is accessed, the payload of current TCP is displayed for 3 seconds. If the joint range is exceeded during direct teaching, the LED color of tool flange will turn pink.
- **Home**: Shifts the robot to its initial position.
- **Speed**: Adjusts the movement speed of the robotic arm when you control the robotic arm manually.
- **Inching**: You can set the robot to move in increments of a certain distance or angle.
 - Default: 5mm, 5degree
 - Moving Range : 0.01~10 mm

– Rotating Range : 0.01~ 10degree

Note Depending on the purpose of the menu that uses the manual robot control function, the screen layout may differ accordingly.

If you press the coordinate value on the screen, the screen will be changed as follows, and then you can enter the coordinates and the joint angles on your own.

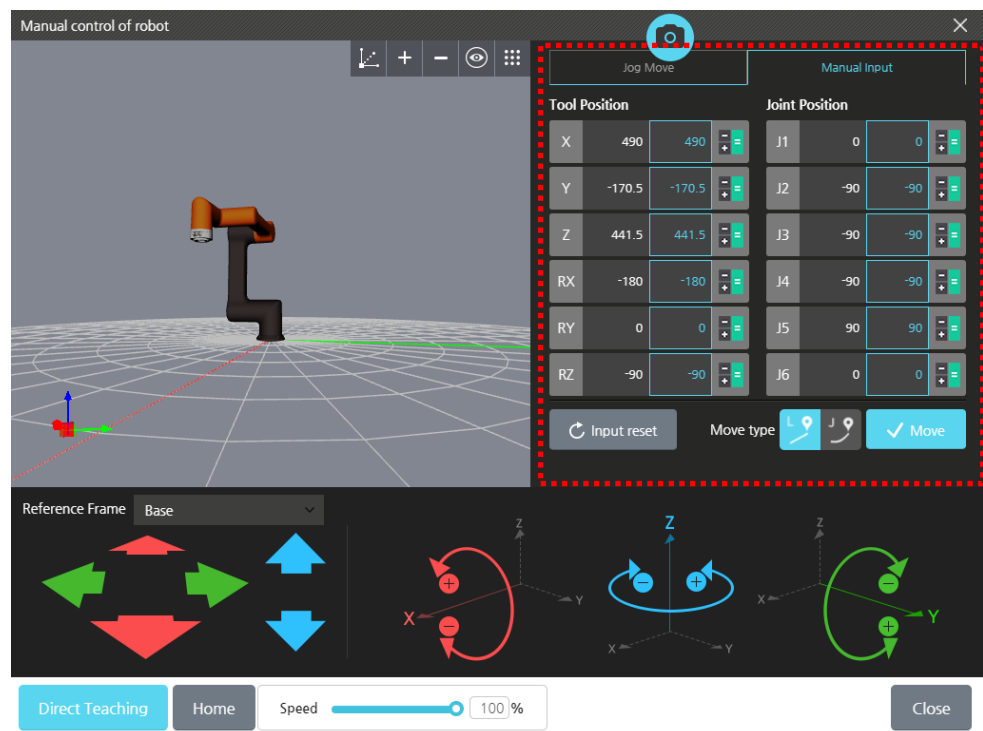

- Press the **Move** button to move the robot arm to the preset position.
- Press the **Input reset** button to reset the coordinates and joint angles you input to the current coordinate of the robot.

Warning

When controlling the robot manually, check that there is no obstacle or person around the robot before operating it.

Caution

-
- When using the direct teaching function, check that the center of gravity of the TCP payload is correctly entered. Entering an incorrect value may cause malfunction.
 - If you drive a joint beyond a certain speed while using the direct teaching function, it may make a noise and make an emergency stop for the safety of operators.
-



5.4 Virtual Keypad

The operation software accepts touch based inputs, so you can use a virtual keypad on the screen. Depending on the input types, there are three types of virtual keypads as follows.

Text keypad

You can enter or edit simple English texts or special characters. You can use the Shift key to toggle between uppercase/lowercase.





- If you want to display your inputted text, press the **Accept** key.
- If you want to delete the entire inputted text string, press the  button.
- If you want to close the keypad, then press the  button at the right top.

Note The **Accept** key is deactivated and cannot be used if there is no inputted text string.

Number keypad

You can enter or edit simple numbers.



- If you want to display your inputted numbers, press the **Enter** key.
- If you want to delete the entire inputted text string, press the  button.
- If you want to close the keypad, then press the  button at the right top.

Note The **Enter** key is deactivated and cannot be used if there is no inputted text string.

Expression keypad

You can enter or edit simple expression.



- Basically, an expression is composed of  three input items.
 - Green input field: You can enter fixed variables and numbers.
 - Orange input field: You can enter an arithmetic operator.
- **Add an expression:** Select a green input field and press the **Add** button. The selected green input items will be changed to the three basic input items and added into the parenthesis.

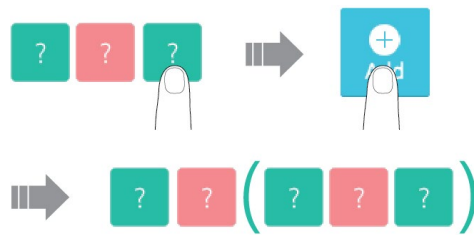

- **Delete an expression:** After selecting any item in the parenthesis, press the **Delete** button. The basic input item added into the parenthesis will be deleted.

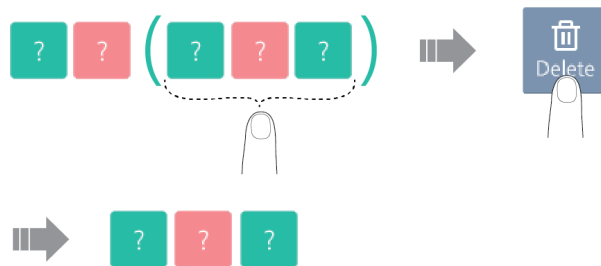

- If you want to delete the selected input item, then press the **Clear** key.
- If you want to display the inputted expression, press the **Enter** key.
- If you want to close the keypad, then press the **X** button at the right top.
- Clicking the script mode  button allows you to enter a free-form equation, such as a script. If this mode is selected, a list of functions available in the script is displayed.

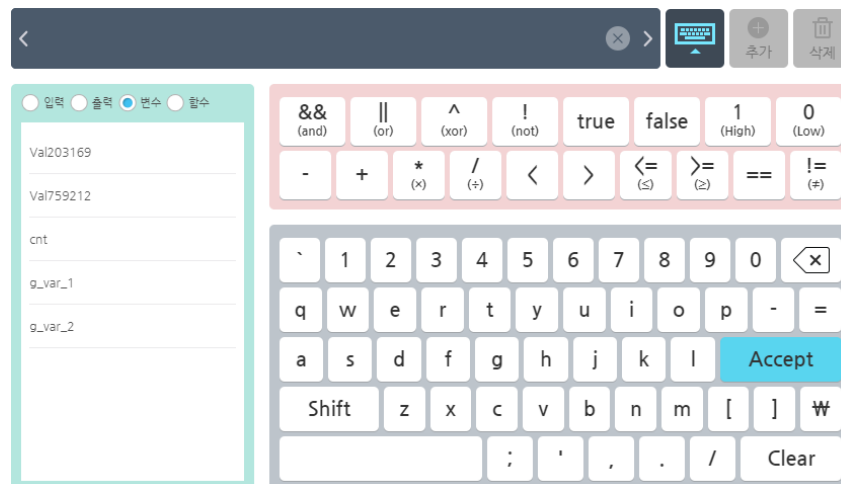

Chapter 6 Registering Robots and Users

After installing the robot, turn on the system for the first time. Only the **Management** menu will be seen. If there is no robot registered, other menus will not be seen.



6.1 Managing Robots





You can register a new robot to be linked to the controller or change the robot name.

In the main menu, select  **Management** > **Robot**.

HCR3



F/T Sensor EMPTY  

Specification	
 Number of Joints	6 ea
 Payload	3 kg
 Reach	630 mm
 Rotation	±360°
 Arm Weight	12.9 kg

Basic Information

Robot Model	HCR3
Robot Name	<input type="text" value="New_HCR3_1"/>

Advanced Information

Over speed input mode	Off
Jerk	0.5
Almost complete event time	0.1 seconds

Registering robots

1. Press the **Add** button.
2. Add a robot and press the **OK** button.

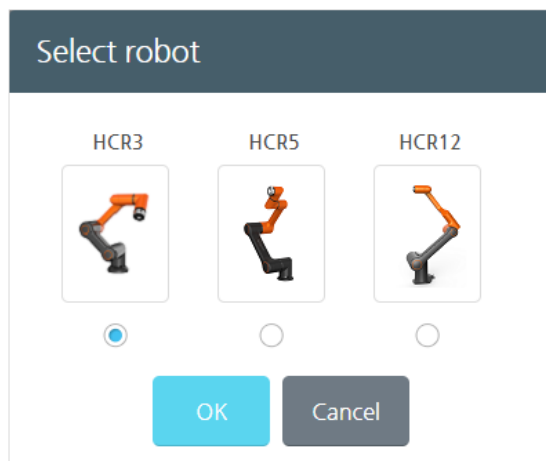

3. Enter the robot name and press the **Apply** button.
4. When the restart confirmation window appears, press the **OK** button.
 - You must restart the system for normal operation.

Deleting robots

1. In the list of registered robots, select a robot.
2. Press the **Delete** button.
3. When the confirmation window appears, press the **OK** button.
4. Press the **Apply** button.

Note If you want to delete a robot, then you must restart the system.

Modifying the robot name

1. In the list of registered robots, select a robot.
2. After pressing the text box having the robot name, modify it as you want.

Basic Information	
Robot Model	HCR3
Robot Name	HCR3

3. Press the **Apply** button.

6.2 Managing Users

You can make sure only specific users can use the software by registering them. Also, you can grant an individual right to each user to limit their access to the menus.

In the main menu, select **Management > User**.

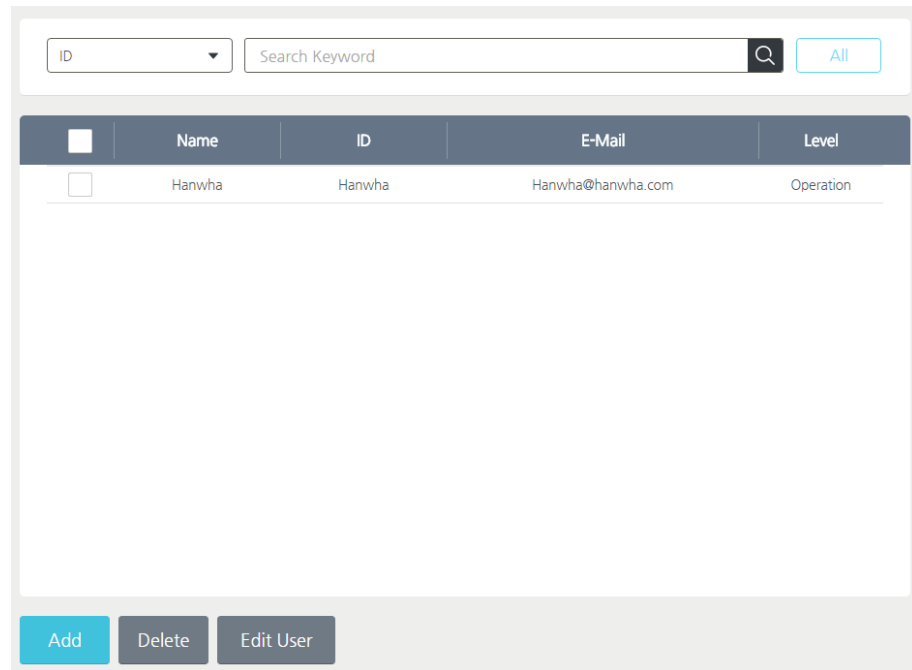

Adding users and setting authorities

1. Press the **Add** button.
2. Set the user information and their authorities and press the **OK** button.

Dialog: Add

Name	<input type="text"/>	ID	<input type="text"/>
User Authority	Select <input type="text"/>		
Password	<input type="text"/>	Confirm Password	<input type="text"/>

Buttons: OK, Cancel

- The length of text that can be inputted is limited as follows.
 - **Name**: 25 letters
 - **ID/Password**: 20 letters

- You can choose one of the following two authorities.
 - **Admin:** Can use all the functions of the software.
 - **Operation:** Cannot use the safety and the critical setting functions. Settings can be all inquired about.

- | | |
|-------------|--|
| Note | <ul style="list-style-type: none"> • If you are an operation user who lost the password, ask the admin user. The admin user can modify the password for an operation user. • If the admin user's password is lost, then contact local distributor. |
|-------------|--|

Menu available to each authority

Depending on the authority set in User Management, the following menus become available. Even if you are not logged in, you can still use some menus.

Main menu	Sub menu	Admin	Operator	Log Off
Robot Operation		○	○	○
Programming		○	○	X
Monitoring	Robot Status	○	○	○
	I/O Status	○	○	○
	Utilization	○	○	○
Robot Setting	TCP Setup	○	○	X
	Mounting	○	X	X
	I/O Setup	○	○	X
	Coordinate	○	○	X
	Global Variables	○	○	X
	I/O Bit Operation	○	○	X
	Safety Setting	Motion Limit	○	△
Safety I/O		○	△	X
Safety Boundary		○	△	X
Safe Guard		○	X	X
Device Setting	MODBUS TCP	○	○	X
	Vision System	○	○	X

Main menu	Sub menu	Admin	Operator	Log Off
Management	User	O	X	X
	Robot	O	O	X
	Log	O	O	O
	Setting Management	O	O	X
SW Configuration	General	O	O	X
	Network	O	O	O
	SW update	O	O	X
	Shutdown	O	O	X
Zeroing Robot		X	X	X

Note

- The **Zeroing Robot** menu is only accessible by the Super Admin user.
- If you need assistance with zeroing, contact the manufacturer or a local distributor.

6.3 Login/Logout

Logging In

While logged off, the  icon is displayed at the right top of the screen. After finishing registering a user, while logged off, press the  icon and enter your ID/password and press the **Login** button.

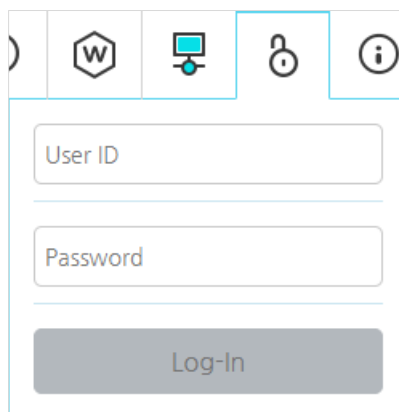

The screenshot shows a user interface for logging in. At the top, there is a navigation bar with several icons: a home icon, a 'W' icon, a computer monitor icon, a lock icon (which is highlighted with a blue border), and an information icon. Below the navigation bar is a login form with three main components: a text input field labeled 'User ID', a text input field labeled 'Password', and a grey button labeled 'Log-In'.

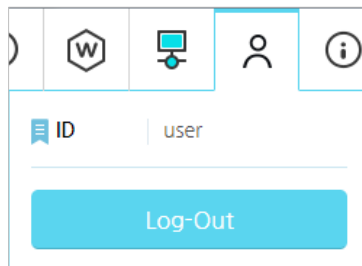

Logging out

While logged in, the  icon is displayed at the right top of the screen. While logged in, press the  icon and press the **Logout** button.



6.4 Checking Status

Checking robot status

You can check the status of the robot through the robot icon  next to the robot name and the status icon  in the upper right of the screen.

- Green: Servo On
- Red: Servo Off

Checking errors

You can check errors that occur while the robot is in operation or being programmed when error status is shown by the  status icon on the top right of the screen.

- Red number: Shows the number of errors that occurred

When you click the icon, an error message is displayed, as shown in the figure below. The error message shows the error title, error details, error target, and error time.

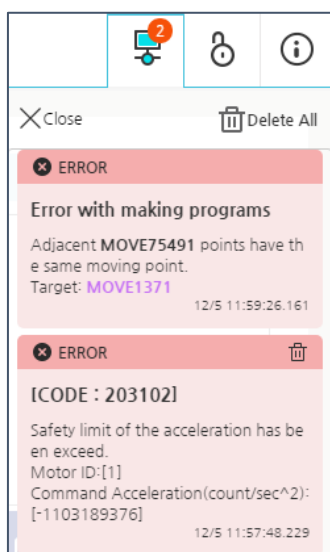

Checking the software version

You can check the current version of the operating software and control software by clicking the  information display icon at the top of the screen.

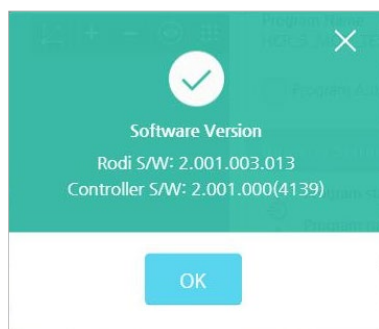

- Operating software: Displays the operating software version.
- Control software: Displays the control software version.

Chapter 7 Setting Robots

7.1 Setting the Robot Installation Angles

After installing a robot, you must set the robot installation angle.

The purpose of this process is to make sure that actual operation of the robot arm looks same as what we saw in the preview screen and let the controller know the direction of gravity.

Warning

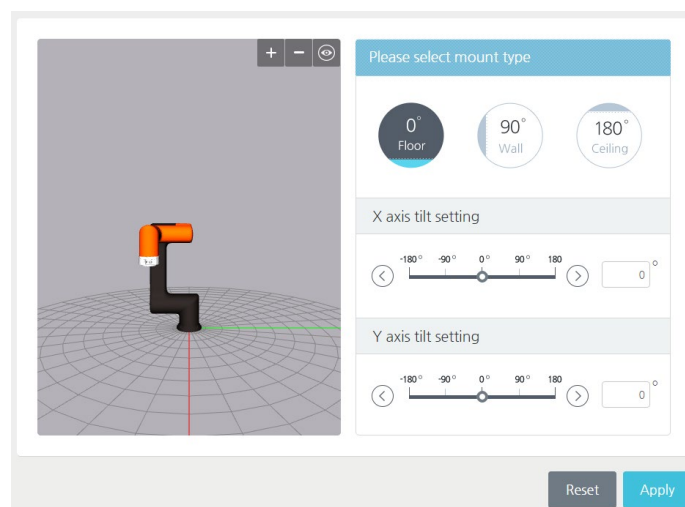

The system is unable to automatically recognize the tilt of the ground where the robot arm's base is installed and the working range, so before operating the robot, you must enter accurate inputs depending on the installation type.

In the main menu, select the  **Robot Setting** > **Mounting** menu.



- Depending on the tilt of the ground where the robot arm's base is installed, set the angle accordingly.
 - If installed on the ground, then press **0°**, if installed on the wall, press **90°**, or if installed on the ceiling, press **180°** to set the tilt value more quickly.



- You can touch the gauge or press the left/right   buttons to fine tune the tilt for the X/Y axis.



-  You can touch the input window to enter the angle value directly.
- Press the **Apply** button to apply the settings to the system.
 - Press the **Cancel** button to revert to the previous settings.

7.2 Setting TCP

When you mount a tool in the robot arm for the first time, you must also set the TCP (Tool Center Point). By setting the tip location/direction and the weight of the mounted tool, you can calculate the robot's motion.

You can set a different TCP for each of multiple robots linked, and if you want to use multiple tools for a single robot, then you can save different settings and retrieve and apply them to a newly replaced tool.

To set the TCP, in the main menu, select  **Robot Setting** > **TCP Setup**.

Warning

If the TCP profile is incorrectly entered, accidents such as collision and jamming may occur while operating the robot and the robot may operate incorrectly while using the direct teaching function. In addition, as the singularity of the robot arm may vary depending on the TCP, the program previously prepared may not work or the robot arm may not operate as expected. Make sure to enter the correct value according to the TCP type before operating the robot.

Creating a new TCP profile

1. Press the **Add** button.



2. Enter the new TCP name and press the **OK** button.

- You may enter up to 25 characters. Special characters other than '-' and '_' are not allowed.

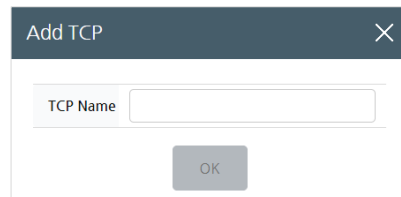

3. Enter the TCP information.

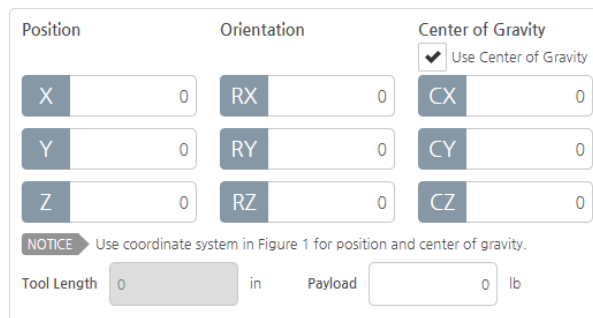

- **Position:** Enter the coordinate values (X, Y, Z) with respect to the center of the cross section of the location where a tool is mounted. The unit is in mm.
- **Orientation:** Set the tool direction (Rx, Ry, Rz).
- **Center of Gravity:** Set the center of weight for a tool.
 - Check the checkbox to enable the option.
 - If you do not use the option, all the values are set to zero.
 - Min: -700, max: 700, The unit is in mm.

- **Tool Length:** Indicates the tool length.
 - The tool length is automatically calculated but users cannot enter it on their own.
- **Payload:** Set the tool weight.
 - If not specified, it will not be saved and an error message will appear.

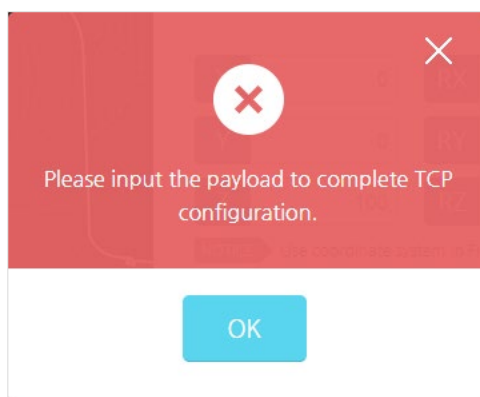

4. Press the **Save** button.
 - If successfully saved, then the **Set Active TCP** button is activated.
5. If you want to apply the newly set TCP profile to the robot, press the **Set Active TCP** button.
 - The robot will receive the currently selected TCP profile setting values.

Note	<ul style="list-style-type: none">• If no TCP is set in the robot, then the “Empty” TCP is set by default.• Default settings for Empty TCP: Position (0,0,0); Orientation (0,0,0); Center of Gravity (0,0,0) with the Use check box cleared.
-------------	---

Calculating the TCP position

By using the direct teaching function, you can calculate the position of TCP.

To calculate the position of TCP accurately, receive the position data from various angles with respect to one point and analyze them.

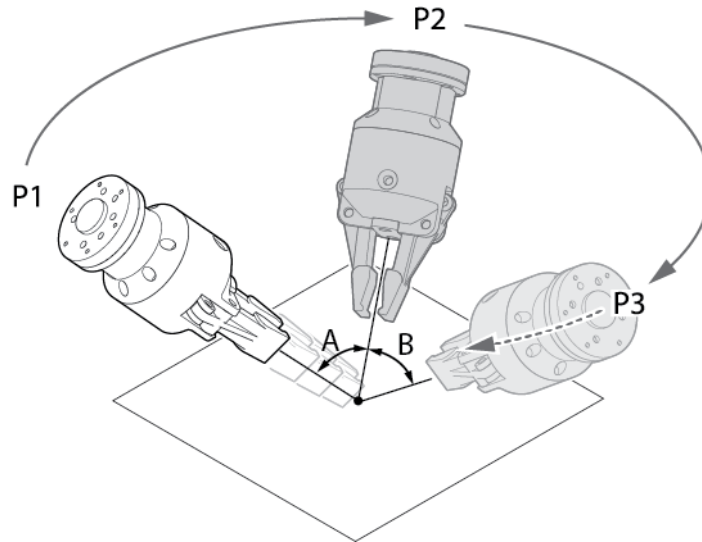

After moving a tool to face a certain point at P1, enter the position data. After that, move to an arbitrary point, P2 and let it face the same point and enter the position data. Proceed this way until you have at least three points. The angle between each point (A, B) should be at least 10°.

Note

- A tool is not included in the product package.
- The TCP location may not be calculated correctly depending on the tool shape or the TCP movement.
- Since only the TCP location is calculated, you should enter the weight and the center of gravity of the tool before direct teaching.

To calculate the position of TCP, proceed as follows.

1. After pressing the **Edit** button, press the **Position** button.

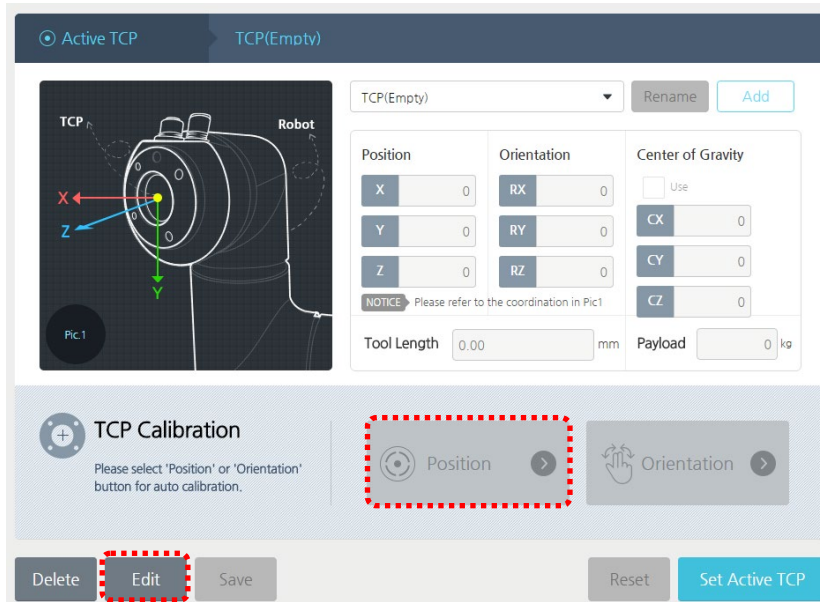

2. Press the **Teaching** button.

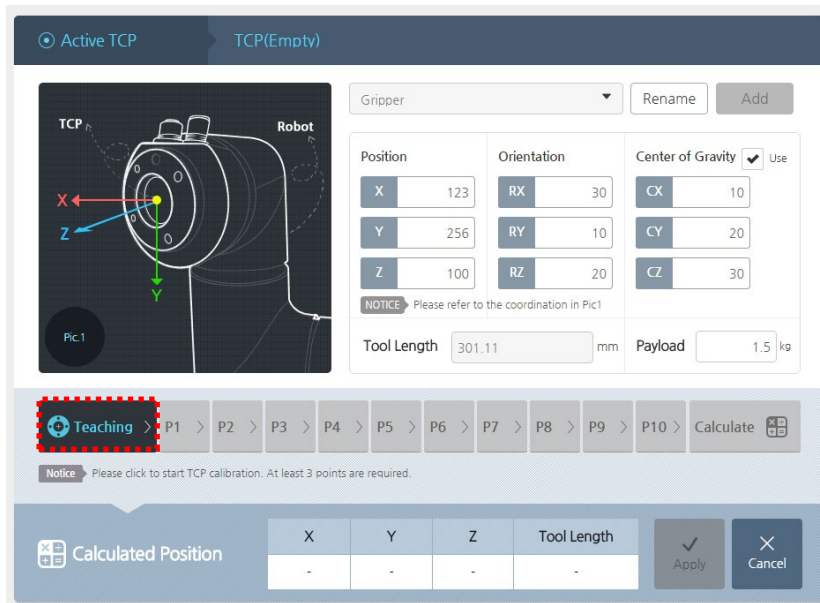

3. Press the **P1** button when it is activated.
 - If you press the **P1** button, the **Manual Move** screen will appear.

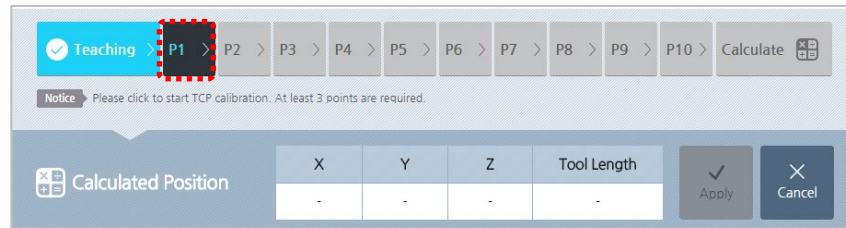

4. While pressing down the **Direct Teaching** button in the **Manual Move** screen, move the robot arm to place the tip of the tool right at the reference point.
 - For more descriptions on the **Manual Move** screen, refer to 5.3 Manual Move Screen.

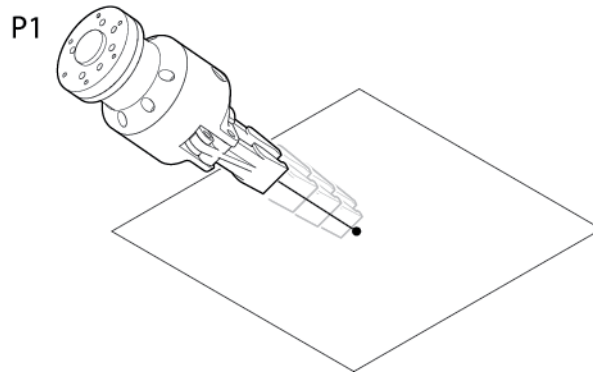

5. In the **Manual Move** screen, press the **OK** button.
6. When the **P2** button is activated, repeat steps 3 through 5.
 - An error will occur if the previously inputted coordinate and the currently inputted coordinate do not differ by more than 10°. The point button with errors will be marked in red. If an error occurs, then you need to change and reset the angle for that point.



- The more the point data is, the more accurate the calculation result becomes. You can set the maximum 10 points.

7. Press the **Calculate** button.
 - The **Calculate** button will be activated only if the minimum three points are set properly.

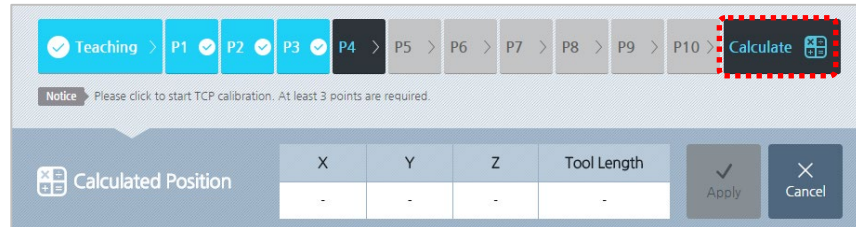

8. Check the calculated position result and press the **Apply** button.
 - Press the **Cancel** button to cancel the task.

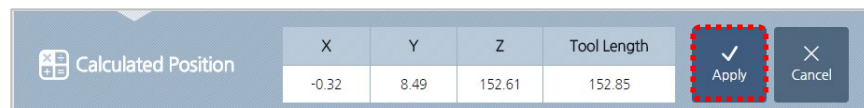

Setting the TCP orientation

You can calculate the orientation of the tool in the tool coordinate system automatically.

1. Press the **Edit** button and press the **Orientation** button.

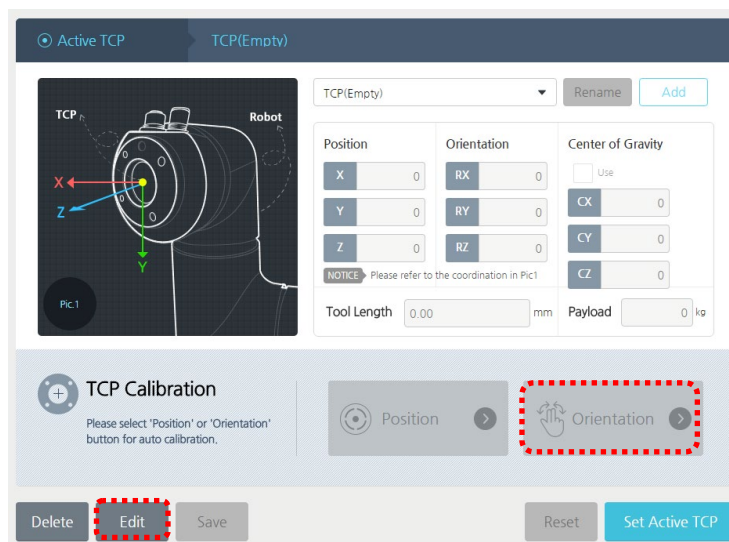

2. Press the **Set Orientation** button.
 - If you press the **Set Orientation** button, the **Manual Move** screen will appear.

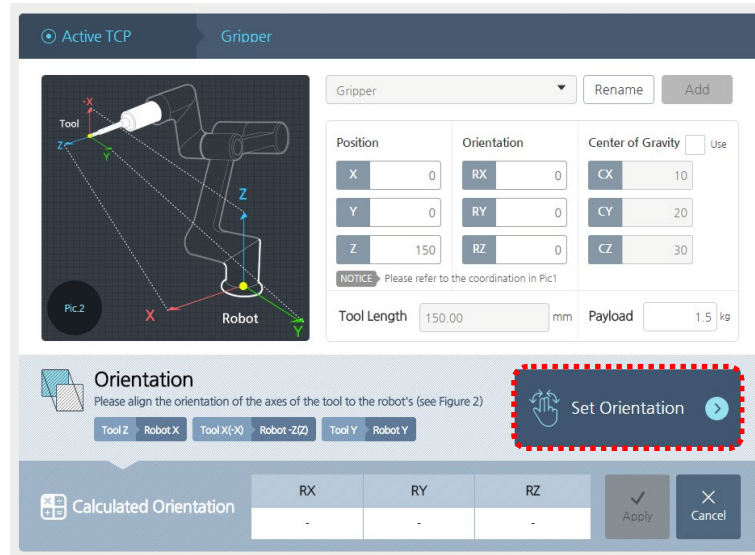

3. In the **Manual Move** screen, use jog control and **Direct Teaching** button to adjust the tool orientation as follows.
 - For more details on the **Manual Move** screen, refer to 5.3 Manual Move Screen.
 - As shown in the figure below, let the Z, -X, and Y axes for the tool face the same direction as the X, Z, and Y axes for the robot base respectively.

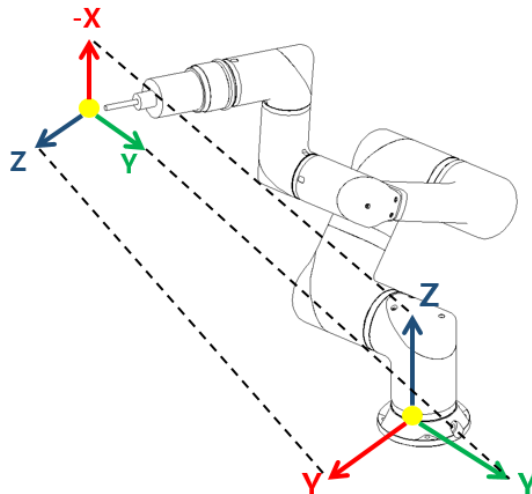

4. In the **Manual Move** screen, press the **OK** button.

5. Press the **Apply** button to apply the settings to the system.
 - Press the **Cancel** button to cancel the task.

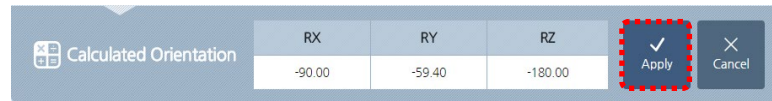

Changing the TCP profile name

6. Select the TCP setting profile to modify.



7. Press the **Edit** button.
8. Press the **Rename** button.
9. Enter the desired name and press the **OK** button.
 - You can enter the max 25 letters but cannot use special characters.
10. Press the **Save** button.

Editing the TCP profile

After checking the name of TCP profile currently used by the selected robot, and proceed as follows.

1. Select the TCP profile to edit.
2. Press the **Edit** button.
 - You cannot edit the TCP profile currently being used by another robot.
 - You cannot edit an empty profile.
 - While you are editing it, the **Set Active TCP** button is deactivated.
3. When you are finished with modifications, press the **Save** button.
 - When you are finished with saving, the **Set Active TCP** button is activated.
 - If you want to revert the modified settings to the previous setting, then press the **Cancel** button.

Deleting the TCP profile

After checking the name of TCP profile currently used by the selected robot, and proceed as follows.

1. Select the TCP profile to modify.
2. Press the **Delete** button.
 - You cannot delete the TCP profile currently being used by another robot.
 - You cannot delete an empty profile.
3. Press the **OK** button.

7.3 Setting Inputs/Outputs

By changing the name of I/O used by the controller, you can make sure they are easily detected and also assign a function to be executed depending on the input/output signals.

In the main menu, select  **Robot Setting** > **I/O Setup**.







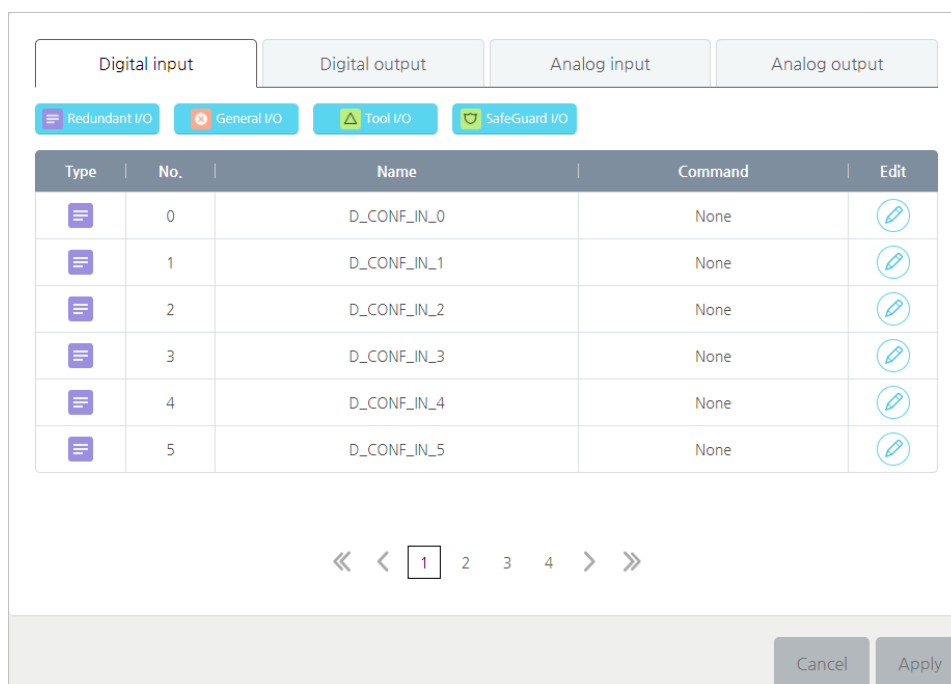





Types of digital I/O

There are three types of digital I/O as follows.

- **Redundant I/O**: Input and output with duplexed connections for the safety purposes.
- **General I/O**: Input and output for general purposes.
- **Tool I/O**: Input and output related to tools.
- **SafeGuard I/O**: Input Of Safeguard Stop.



The screenshot shows the 'Digital input' configuration screen. At the top, there are four tabs: 'Digital input' (selected), 'Digital output', 'Analog input', and 'Analog output'. Below the tabs are four buttons: 'Redundant I/O' (purple), 'General I/O' (orange), 'Tool I/O' (yellow), and 'SafeGuard I/O' (green). The main area contains a table with the following data:

Type	No.	Name	Command	Edit
	0	D_CONF_IN_0	None	
	1	D_CONF_IN_1	None	
	2	D_CONF_IN_2	None	
	3	D_CONF_IN_3	None	
	4	D_CONF_IN_4	None	
	5	D_CONF_IN_5	None	

At the bottom of the table, there is a navigation bar with the following controls: a double left arrow, a left arrow, a box containing the number '1', the numbers '2', '3', and '4', a right arrow, and a double right arrow. At the bottom right of the screen, there are two buttons: 'Cancel' and 'Apply'.

Editing the digital inputs settings

Press the **Edit**  icon for the digital I/O item to modify. The following edit window will appear.

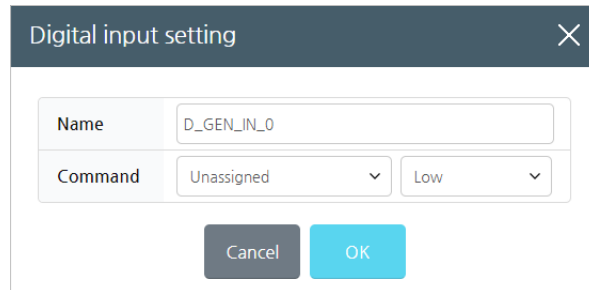

- **Name:** Use a name easy for a user to identify or the existing name.
 - You cannot use the same name already in use by another I/O.
 - Max 15 letters (30 bytes) are allowed. Special characters cannot be used.
- **Command:** Set the command to be executed when the preset value (**Low/High**) is inputted or outputted to the I/O terminal.
 - **Unassigned:** The I/O is not used.
 - **Program Play:** Start the program.
 - **Program Stop:** Stop the program.
 - **Program Pause:** Pause the program.
 - **Reduced Mode:** Reduce Robot Speed.
 - **DirectTeaching Mode:** Switch Robot to Direct Teaching Mode.

Note You can only change the name, if it is a redundant I/O.

Editing the digital outputs settings

Press the **Edit**  icon for the digital I/O item to modify. The following edit window will appear.

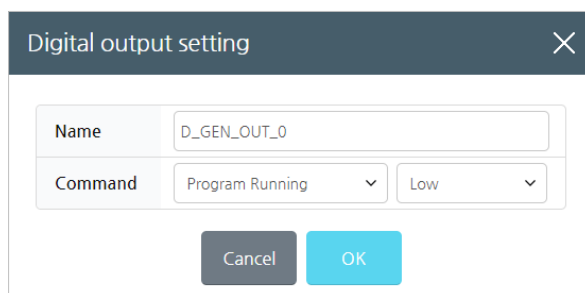

- **Name:** Use a name easy for a user to identify or the existing name.
 - You cannot use the same name already in use by another I/O.
 - Max 15 letters (30 bytes) are allowed. Special characters cannot be used.
- **Command:** When the robot is in the state of the set command, the value set(**Low/High**) to the output terminal is output.
 - **Unassigned:** The I/O is not used.
 - **Program Running:** Outputs the set value when the program is executed.
 - **Program Stopped:** Outputs the set value when the program stops.
 - **Program Runtime Error:** Outputs the set value when error occurs

Note You can only change the name, if it is a redundant I/O.

Types of analog I/O

There are three types of analog I/O as follows.

- **General I/O:** Input and output for general purposes.
- **Tool I/O:** Input and output related to tools.

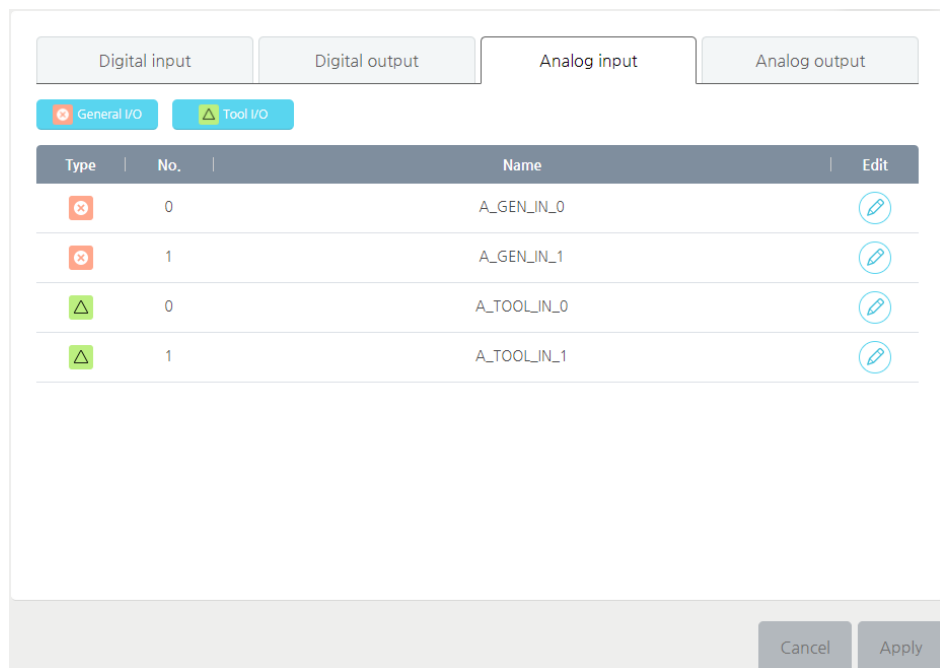

Editing the analog I/O setting

Press the **Edit**  icon of the analog input or output item to modify and the editing window will appear as follows:

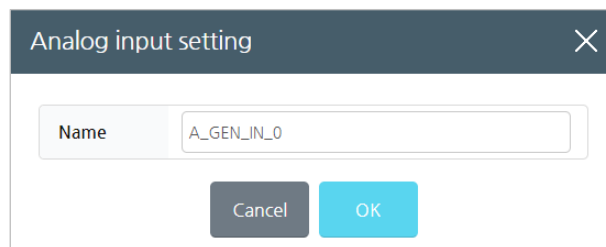

- **Name:** Use a name easy for a user to identify or change the existing name.
 - You cannot use the same name already in use by another I/O.
 - Max 15 letters (30 bytes) are allowed. Special characters cannot be used.

Note For analog I/O, you can only change its name.

7.4 Coordinates

You can set the location information that is available in the program and other setup menus.

From the main menu, select  Robot Settings > coordinates.

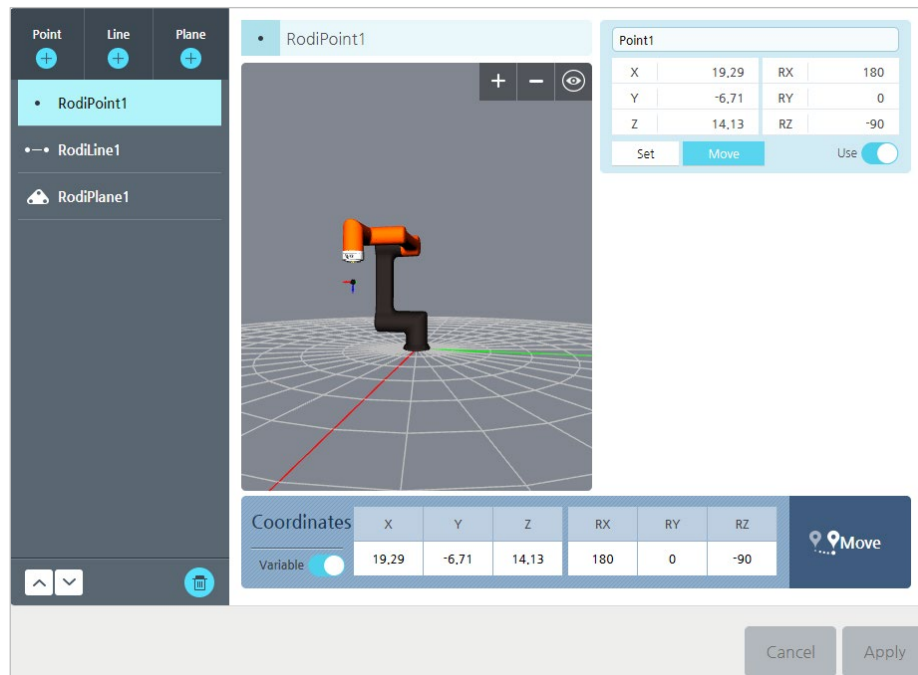

- Point: Add a point.
- Line: Add a line consisting of two points.
- Plane: Add a plane consisting of 3 points.
- Coordinates generated by a point, a line, and a plane are available when you a variable is selected.
- Points consisting of each of them are available when Enable is selected.

When you select the name of a point, the input tool that allows you to edit is displayed. (Up to 25 characters)

Registering points

You can add and set point coordinates.

- The position where the point coordinates are set becomes the reference position, and the coordinate system is set to the same coordinate system in which TCP was set.

Registering line coordinates

You can add and set line coordinates.

- Click point 1 and point 2 to set two points to define a line.
- Coordinate system information
 - Reference point: The first point becomes the reference point.
 - Y axis: The direction of the first point to the second point is the Y axis.
 - Z axis: This becomes the robot's Z axis.
 - X axis: This is set to the other axis.



Registering plane coordinates

You can add and set plane coordinates.

- To define a plane, set point 1, point 2, and point 3 in sequence.
- Coordinate system information
 - Reference point: The first point becomes the reference point.
 - Y axis: The direction of the first point to the second point is the Y axis.
 - Z axis: Select the Z axis using the right-hand rule in three rotation directions together with the third point.
 - X axis: This is set to the other axis.

7.5 Setting Global Variables

You can set the global variables that are available and shared by many programs by restarting the system.

<input type="checkbox"/>	Name	Type	Value	Edit
<input type="checkbox"/>	g_var_1	number	5	
<input type="checkbox"/>	g_var_2	number	41	

Add global variable ✕

Name

Value

« < 1 > »

- **Variable name:** Specifies a variable name.
 - Up to 10 characters (20 bytes) can be entered.
- **Variable value:** Specifies a variable value.
 - Range : -2147483647 – 2147483647

7.6 I/O Bit Operation

You can combine the values of multiple digital I/O inputs, and assign them to variables or assign them to actions.

<input type="checkbox"/>	D_GEN_IN_7	D_GEN_IN_6	D_GEN_IN_5	D_GEN_IN_4	D_GEN_IN_3	D_GEN_IN_2	D_GEN_IN_1	D_GEN_IN_0	Value	Function
<input type="checkbox"/>									1	Program Stop
<input type="checkbox"/>									3	Program Play
<input type="checkbox"/>									4	Program Pause
<input type="checkbox"/>									2	Unassigned

Add/Delete

Add or delete bit operation settings.

- Clicking the Add button adds one setting, and the initial value of each IO is displayed as Low.
- The Delete button is enabled when any check box in a row is selected. If it is clicked, the selected row will be deleted.
- Settings cannot be added while the program is running or started.

I/O bit operation settings

Set I/O bit operation value and assign a function.

- Each time you click the I/O bit icon, it changes, through a sequence of Low/High/Disable.
- High is assigned to 1, Low is assigned to 0, and the bit operated value is displayed in the value field.
- The IO of the bit set to Disable is treated as '0' regardless of the actual value received.

Chapter 8 Safety Settings

After configuring the installation settings, you must configure the safety settings to protect users against the dangerous situation that can arise during robot operation.

Warning

Make sure to check safety settings immediately after the robot is installed. In addition, all of the functions for safety settings must be regularly checked.

8.1 Limiting Robot Movement

To guarantee the user's safety while interacting with the robot, you can make sure that the angle and speed of robot joint does not exceed a certain limit.

Press  **Safety Setting** > **Motion Limit** in the main menu.

The screenshot displays the Safety Settings configuration window. At the top, there is a 'Preset' checkbox and four radio buttons for Preset 1, Preset 2, Preset 3, and Preset 4. Below this, there are five main sections:

- Torque(Nm):** A slider from 25 to 150 with an input box containing '35'.
- Force(N):** A slider from 100 to 250 with an input box containing '150'.
- Speed(mm/s):** A slider from 0.1 to 1000 with an input box containing '1000'.
- Collision mitigation:** Two buttons: 'Enable' (checked) and 'Disable'.
- Speed (Reduced)(%):** A slider from 1 to 100 with an input box containing '50'.

Below these sections are two tabs: 'Joint Rotation(°)' and 'Joint Speed(°/s)'. The 'Joint Rotation(°)' tab is active and shows six joints with their respective minimum and maximum rotation limits:

Joint	Min (°)	Max (°)
Joint1	-360	360
Joint2	-360	360
Joint3	-165	165
Joint4	-360	360
Joint5	-360	360
Joint6	-360	360

At the bottom right, there are 'Cancel' and 'Apply' buttons.

Default settings

Depending on the limitation on each item, four sets of default settings are provided.

If you want to use the default setting, check **Preset** and select one out of the four choices.

This partial screenshot shows the top portion of the Safety Settings window, including the 'Preset' checkbox and the four radio buttons for Preset 1, Preset 2, Preset 3, and Preset 4.

Manual setting method

If you want to set each item on your own, you can use the adjustment bar to change the value while **Preset** is not checked. Or, after pressing the input box, you can enter your own inputs.

This screenshot shows the Safety Settings configuration window with different values than the first screenshot. The 'Preset' checkbox is unchecked. The values are:

- Torque(Nm):** Slider at 25, input box '35'.
- Force(N):** Slider at 100, input box '150'.
- Speed(mm/s):** Slider at 0.1, input box '1000'.
- Collision mitigation:** 'Enable' button is checked, 'Disable' button is visible.
- Speed (Reduced)(%):** Slider at 1, input box '50'.

The joint rotation limits are the same as in the first screenshot.

There are four different ways to limit the robot's movement.

- **Torque:** You can limit the max force that the robot(TCP) is exerting to the outside.
- **Force:** TBD
- **Speed:** You can limit the max speed for the TCP's linear movement.
- **Collision mitigation:** This can be set to mitigate the impact of a target object in the event of a collision.
- **Deceleration mode speed (%):** Sets the speed in deceleration mode. When deceleration mode is applied, a red alarm occurs at the top of the screen. Clicking the alarm moves you to the initial screen.
- **Joint Rotation:** You can limit the angle of each joint.
- **Joint Speed:** You can limit the speed of each joint.

Press the **Cancel** button to revert the settings newly changed by a user in the current tab (general mode or deceleration mode) to the previous value.

When the settings are complete, press the **Apply** button to apply it to the robot.

 **Caution**

- The joint speed cannot be limited with the **Speed** option. You can limit the joint speed only with the options in the **Joint Speed** tab.
 - If the temperature of the operating environment for the robot arm is not greater than 10 °C during the initial start, collision detection may occur due to the limited force. If such problem occurs, increase the limit value of **Force** sufficiently, operate it at a low speed for about 30 to 60 minutes for preheating, and lower the **Force** value to use it.
-

8.2 Setting Safety Boundaries

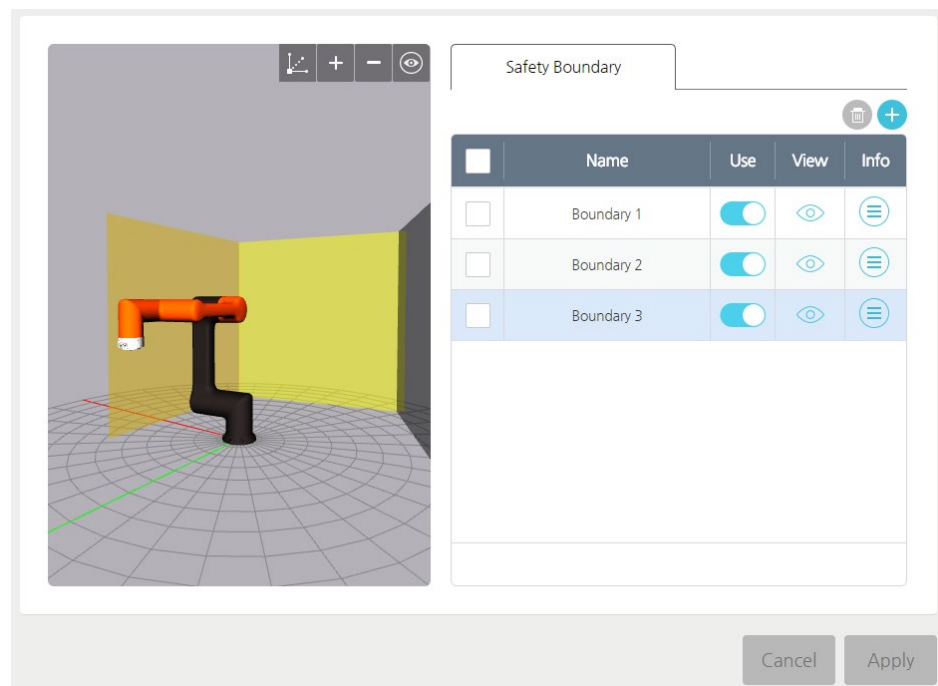

To improve user safety, you can build virtual fences around the robot to prevent the TCP from moving beyond the boundary of these virtual fences.

Press  **Safety Setting** > **Safety Boundary** in the main menu.



Adding safety boundary planes

After adding multiple safety boundary planes, if necessary, you can select one of them and use it.

- To add a boundary plane, press the Add  button.
 - If you press the Add  button, the **Manual Move** screen will appear.

Safety Boundary				
<input type="checkbox"/>	Name	Use	View	Info
<input type="checkbox"/>	Boundary 1	<input checked="" type="checkbox"/>	<input checked="" type="checkbox"/>	<input checked="" type="checkbox"/>
<input type="checkbox"/>	Boundary 2	<input checked="" type="checkbox"/>	<input checked="" type="checkbox"/>	<input checked="" type="checkbox"/>
<input type="checkbox"/>	Boundary 3	<input checked="" type="checkbox"/>	<input checked="" type="checkbox"/>	<input checked="" type="checkbox"/>

- In the **Manual Move** screen, use jog control and **Direct Teaching** button to set the boundary position.

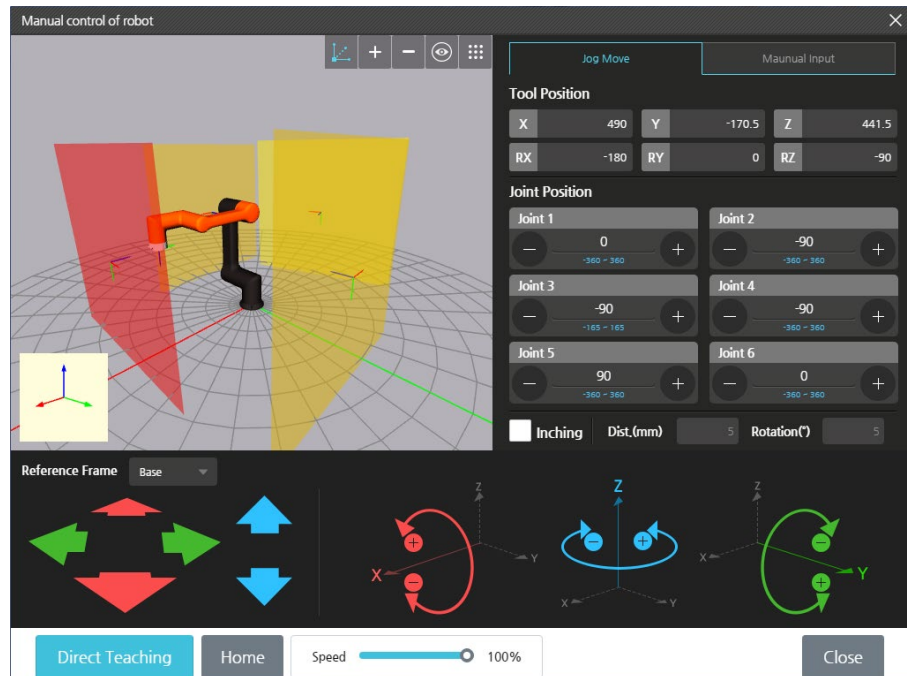



- For more details on the **Manual Move** screen, refer to 5.3 Manual Move Screen.
 - Your safety boundary will be created in a location that is separated from the center axis of the flange as much as the TCP length set in the TCP.
- To save the settings, press the **OK** button.

Viewing safety boundary planes

Press the icon in the **View** column to hide or unhide the safety boundary plane in the preview screen.

<input type="checkbox"/>	Name	Use	View	Info
<input type="checkbox"/>	Boundary 1	<input checked="" type="checkbox"/>	<input checked="" type="checkbox"/>	<input type="checkbox"/>
<input type="checkbox"/>	Boundary 2	<input checked="" type="checkbox"/>	<input checked="" type="checkbox"/>	<input type="checkbox"/>
<input type="checkbox"/>	Boundary 3	<input checked="" type="checkbox"/>	<input checked="" type="checkbox"/>	<input type="checkbox"/>

-  : To display in the preview screen.
-  : Not to display in the preview screen.

Press the **Info**  icon to check the coordinates for the safety boundary.

Boundary Info			
Coordinate	X	Y	Z
Point	431.927	269.533	725.5
Direction	-0.622	-0.783	0

- **Point:** Indicates the center of the 3-D where the center of the safety boundary is located.
- **Direction:** Indicates the direction(vector) for the border plane that can indicate a collision with the safety border in the controller. (Blue Z-axis on the screen)



Applying safety boundaries

1. Activate the boundary for use.

<input type="checkbox"/>	Name	Use	View	Info
<input type="checkbox"/>	Boundary 1	<input checked="" type="checkbox"/>	<input checked="" type="checkbox"/>	<input type="checkbox"/>
<input type="checkbox"/>	Boundary 2	<input checked="" type="checkbox"/>	<input checked="" type="checkbox"/>	<input type="checkbox"/>
<input type="checkbox"/>	Boundary 3	<input checked="" type="checkbox"/>	<input checked="" type="checkbox"/>	<input type="checkbox"/>

-  : To use
-  : Not to use







2. Press the **Apply** button.
 - Press the **Cancel** button to cancel the modifications and revert to the previous settings.

Note If there are eight or more safety boundary planes in the list, press the up/down   button to scroll.

Changing the name of safety boundaries

If you add a safety boundary, it will save as "Boundary" and a number by default.

1. Press the name of boundary to modify.

<input type="checkbox"/>	Name	Use	View	Info
<input type="checkbox"/>	Boundary 1	<input checked="" type="checkbox"/>		
<input type="checkbox"/>	Boundary 2	<input checked="" type="checkbox"/>		
<input type="checkbox"/>	Boundary 3	<input checked="" type="checkbox"/>		







2. Enter the desired name and press the **OK** button.

Boundary Name Edit
✕

Name





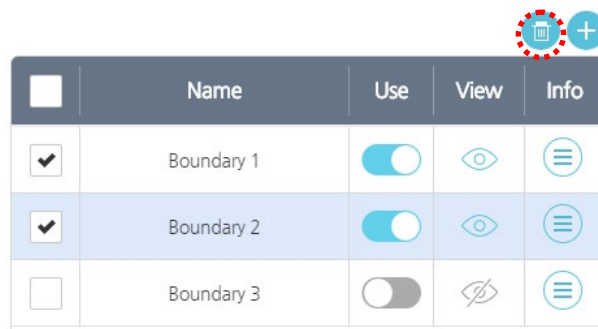

Deleting safety boundary settings

1. Select the safety boundary to delete.

<input type="checkbox"/>	Name	Use	View	Info
<input checked="" type="checkbox"/>	Boundary 1	<input checked="" type="checkbox"/>		
<input checked="" type="checkbox"/>	Boundary 2	<input checked="" type="checkbox"/>		
<input type="checkbox"/>	Boundary 3	<input type="checkbox"/>		

2. Press the Delete  button.



<input type="checkbox"/>	Name	Use	View	Info
<input checked="" type="checkbox"/>	Boundary 1	<input checked="" type="checkbox"/>		
<input checked="" type="checkbox"/>	Boundary 2	<input checked="" type="checkbox"/>		
<input type="checkbox"/>	Boundary 3	<input type="checkbox"/>		

3. Press the **OK** button.

8.3 Setting Tool Boundaries

The user sets the safety boundary of the set tool, so that the tool does not go beyond the safety boundary of the set working area.

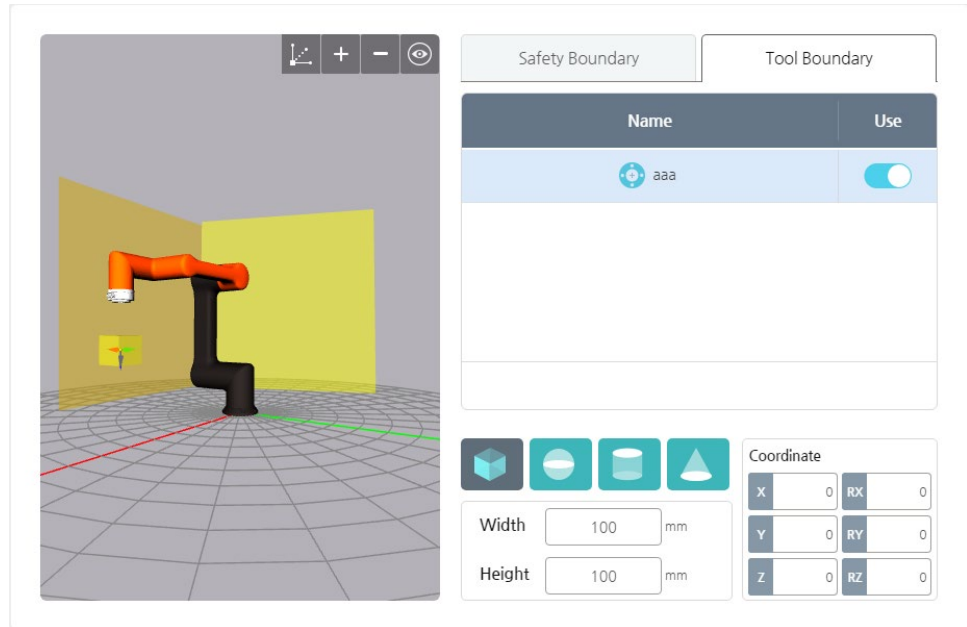

Adding Tool Safety Boundary Surfaces

The safety boundary of the tool can be set only for TCP settings that have already been set.

1. Select the Tool Boundary tab and select an item with the name of the TCP you want to set from the list.
2. When you set the selected TCP to **Use**, a box-shaped tool safety boundary is created on the screen by default.

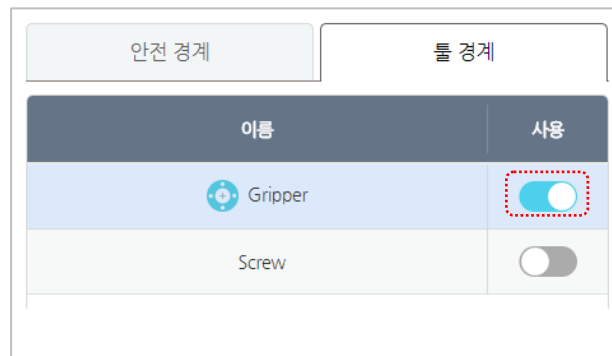

3. The tool boundary surfaces can be set in the following 4 types:

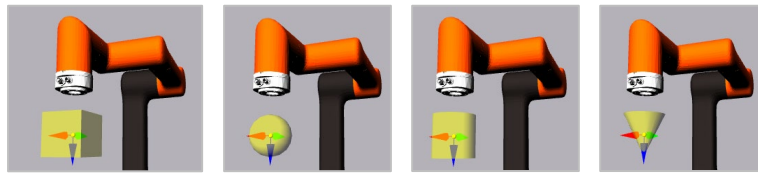





- **Box:** Box-shaped boundary surface with TCP as the center having the Z axis of the TCP as the height and the X axis as the width
- **Sphere:** Spherical boundary surface with constant radius and with TCP as the center
- **Cylinder:** Cylindrical boundary surface with TCP as the center, having a height in the Z-axis of TCP
- **Cone:** Cone-shaped boundary surface with TCP as the center, having a height and direction in the Z-axis of TCP

For reference

The TCP currently applied to the robot is marked with the . Each boundary surface of the tool has the same coordinate axes as TCP's coordinate axes.

Setting Tool Safety Boundary Surfaces

1. The boundary surfaces of the tool set to **Use** are set to a box by default. The user selects one of the four boundaries for the shape of the tool or the desired shape.
2. The selected boundaries are displayed on the screen, and the radius, height, width, etc. are set according to the selected form. In addition, you can move and set them based on the TCP coordinates, and enter the rotation angle along the coordinate axis.

				Coordinate		
Width	<input type="text" value="100"/>	mm	X	<input type="text" value="0"/>	RX	<input type="text" value="0"/>
Height	<input type="text" value="100"/>	mm	Y	<input type="text" value="0"/>	RY	<input type="text" value="0"/>
			Z	<input type="text" value="0"/>	RZ	<input type="text" value="0"/>

Applying Tool Safety Boundary Surfaces

1. Switch the boundary surface you want to set to the TCP to **Use** or **Not Use**.
2. Press the **Apply** button.

Press the **Cancel** button to cancel the current settings and return to the previous setting.

For reference

Pressing the **Apply/Cancel** buttons simultaneously applies **the safety boundary of the working area to the safety boundary of the tool.**

8.4 Setting Redundant I/O

To guarantee the safety of the I/O terminal or input/output the important data, you can opt for using a redundant I/O, not a single I/O. If you set the redundant I/O, you are no longer checking a single I/O value. Instead, the two designated inputs or outputs check the High or Low signals to determine validity of values.

In the main menu, press  **Safety Setting > Redundant I/O.**

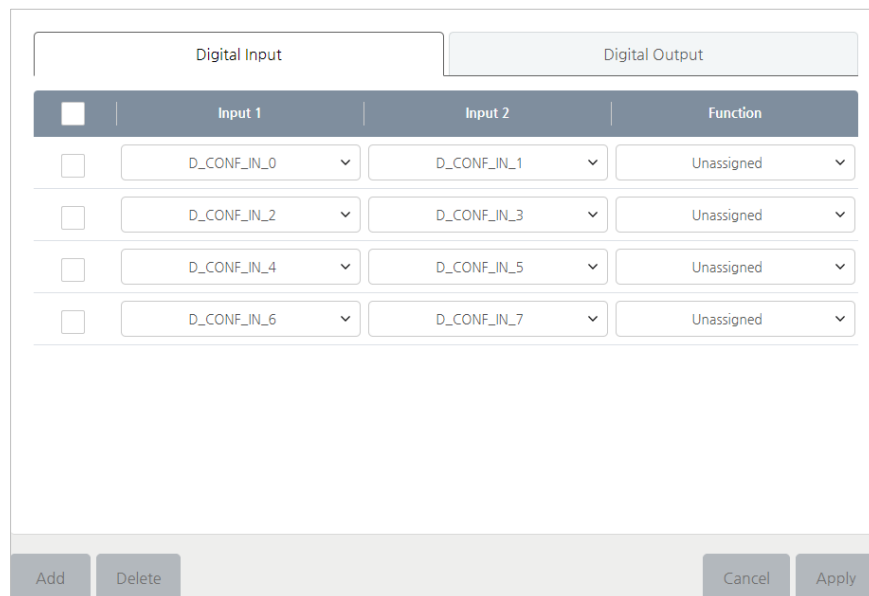

	Input 1	Input 2	Function
<input type="checkbox"/>	D_CONF_IN_0	D_CONF_IN_1	Unassigned
<input type="checkbox"/>	D_CONF_IN_2	D_CONF_IN_3	Unassigned
<input type="checkbox"/>	D_CONF_IN_4	D_CONF_IN_5	Unassigned
<input type="checkbox"/>	D_CONF_IN_6	D_CONF_IN_7	Unassigned

There are two tabs – digital input and digital output. Select the tab to set and proceed as follows.

- In case of digital inputs, the function will operate if the input is high or low.
- In case of digital outputs, the high or low signal is sent for the assigned function.
 1. Press the **Add** button.
 2. Select an I/O terminal to be used as redundant I/O.
 3. Set the function to be assigned.
 - You can assign the following functions to digital inputs.

- **Unassigned:** The function is not assigned.
 - **Emergency Stop:** If the two designated inputs are all Low (0) and the actual emergency stop button is released, it operates as if the emergency stop button is released; and if any of the inputs is High (1), it operates as if the emergency button is pressed.
 - You can assign the following functions to digital outputs.
 - **Unassigned:** The function is not assigned.
 - **Emergency Stop:** If the two designated IOs are in the emergency stop state, Low (0) is output. Otherwise, High (1) is output. When a physical emergency stop button is pressed, it operates even when the designated IO is in the emergency stop state.
 - **Robot Moving:** If the robot moves, the designated output terminal outputs Low (0). Otherwise, it outputs High (1).
 - **Robot Not Stopping:** The designated output terminal outputs High (1) till the time point when the stop command is performed after the stop command is ordered to the robot. Otherwise it outputs Low (0).
4. Press the **Apply** button.
- Press the **Cancel** button to revert to the previous settings.

Note

- User can name each I/O on their own. For more details, refer to [0 Setting Inputs/Outputs](#).

8.5 Setting Safeguard I/O

The user sets the safeguard stop.

In the main menu, press  **Safety Setting** > **Safe Guard**.

Input 1	Input 2	Function
D_SGRD_IN_0	D_SGRD_IN_1	Safeguard Stop
D_SGRD_IN_2	D_SGRD_IN_3	Unassigned

Cancel Apply

- Assign a Safeguard Stop function with the IO.
- Click **Apply** button to apply to the system.

Note Only one Safeguard Stop can be set at a time. Assigning a function to another input will release the function that was previously assigned to the input.

8.6 Exceeding Safety Limit of Joints

If the safety limit of any joint is exceeded, information on the joint exceeding the safety limit is displayed at the top of the screen, as shown in the figure below.

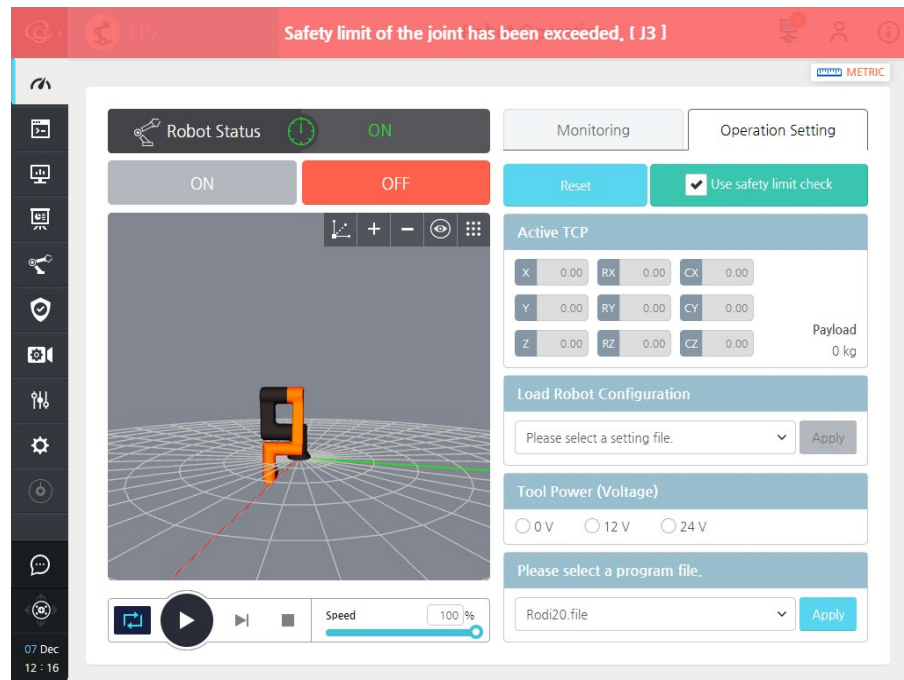

If the safety limit of a joint is exceeded, the system will not operate normally. Therefore, the operating range must be safely set to the normal range, through the following procedure.

- 1. Go to the administration screen by selecting the administration menu or clicking the top guidance message.**
- 2. Uncheck 'Use Safe Settings.'**
- 3. Click the 'Reset' button to perform a reset, then click the 'Start' button.**
- 4. Click Manual Manipulation at the bottom left to go to the manual control screen.**
- 5. Joints that exceed the safety limit are controlled to be within the normal range by using the jog button.**
- 6. If they are within the normal range, return to the operating screen.**
- 7. Check 'Use Safe Settings'.**

Chapter 9 Programming

You need to program the movement ahead of time if you want your robot to perform a certain task.

To program your robot, select  **Programming** in the main menu.

9.1 How to Use Commands

Selecting a flowchart

There are two types of flow charts – main and sub.

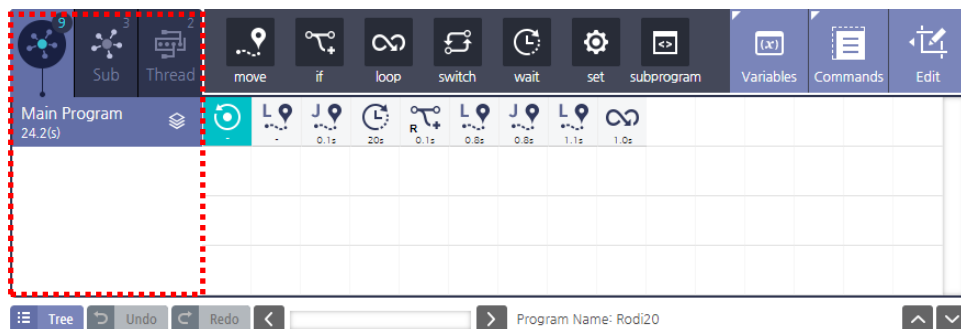

- **Main Program:** In this screen, you can input or modify the main program.
- **Sub Program:** In the main program, you can call multiple sub programs for use. Press the **Sub** tab to move to the screen where you can create or edit a sub program. For more details about the sub program, refer to [9.16 Using a Sub Program](#).
- **Thread Program:** This is a program creation screen that is executed in parallel with the main program.

Type of commands

You can use the following commands in your programming – Move, If, Loop, Switch, Halt, Wait, Set, Loop, Pattern, Sub Program, and Vision.









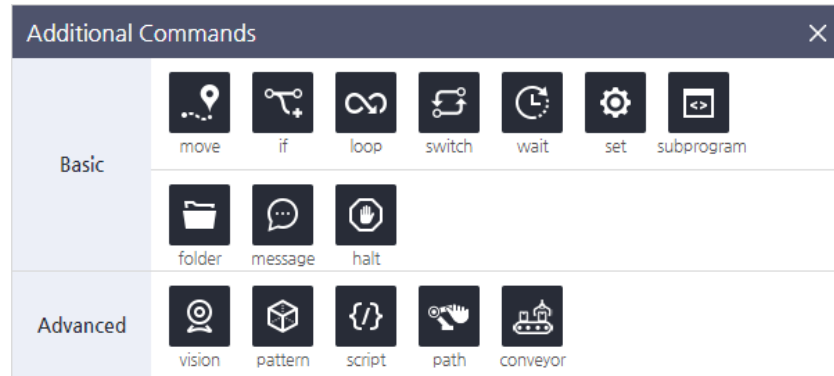

	Move	Set the point that the TCP will move to. For more details, refer to 9.7 Move command .
	If	Branch the commands based on the conditions. For more details, refer to IF Command .
	Loop	Repeat a specific command. For more details, refer to 9.9 LOOP Command .
	Switch	Branch the command for each case of the designated variable. For more details, refer to 9.10 SWITCH Command .
	Wait	Tell the robot to wait until the condition entered by the user is met. For more details, refer to Wait Command .
	Set	Create output signals, variables and TCP profile. For more details, refer to Set Command .
	Sub Program	Call a sub program. For more details, refer to Using a Sub Program .
	Variables	You can manage the variables required for program creation.
	Commands	Indicates that additional commands can be used in addition to the basic commands.
	Edit	Provides editing functions such as copy, cut, paste, delete, and move to the icons of the currently created program.

Additional Commands

In addition to the basic commands, the additional commands that appear when the View Command button  is clicked are Folder, Message, Halt, Conveyor, Vision, Pattern, Script, and Path.





	Folder	Groups the created program command icons and bundles the programs into a sub-folder.
	Message	Define Message Type.
	Halt	Terminate the program.
	Conveyor	Set the operation to be linked with conveyor's movement..
	Vision	Use a vision equipment to scan an object. For more details, refer to 9.18 Vision Command .
	Pattern	Tell the robot to move according to the predefined pattern. For more details, refer to 9.15 PATTERN Command
	Script	Provides Editor to edit scripts.
	Path	Enables the user to directly grasp the robot arm and create motion in order to generate the motion of the robot.

Entering commands

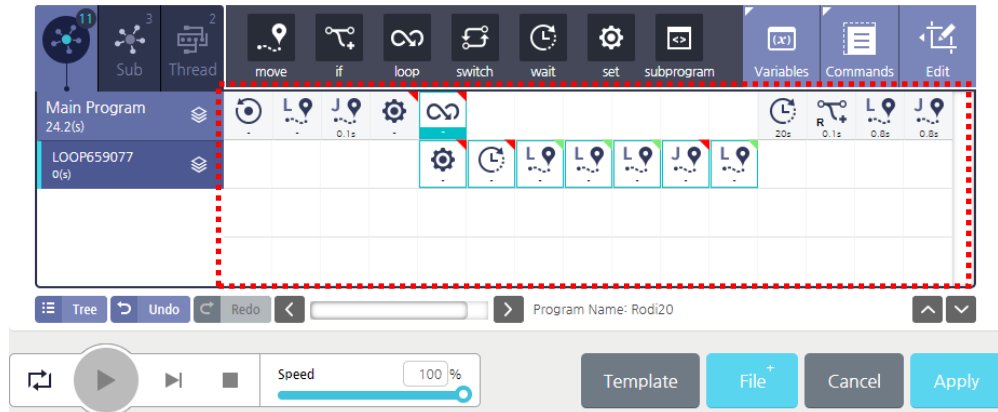

Each time you press a command, it is inputted in the timeline one by one.



- After programming is complete, select the icon  to repeat the entire program continuously.
- If it overflows to the next screen due to too many commands in the flow line, you can press the up/down  or left/right  buttons to scroll.
- At the start of the program, you can initialize variables, IO, robot posture, etc. using the initialization icon. This initialization icon cannot be deleted.

Check Icon Status

The status of the icon indicates the status of the newly added command and the modified command.

-  Command that do not change any parameter after adding new.
-  Command which value has been modified.
- When the program is saved, the current icon state is maintained.
- When clicking the Apply button, all icons are changed to normal state.

Changing command names

Each command offers an option necessary for execution. The same command yields a different result depending on the option setting, so you can designate a different name for each command.

After entering a command in the timeline, press the command name to modify the name.



Deleting commands

1. Select a command to delete in the timeline.
2. Press the **Delete** button.

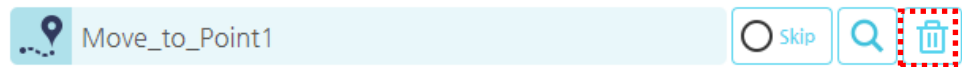

Searching Commands

1. Click the Search button to display the search function on the screen.

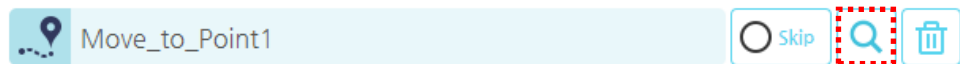

2. Enter the name of a command to be searched, and perform a search.

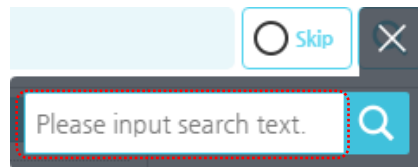

3. If there is a searched command, the number of searched commands is displayed, and you can easily find the command by using the left/right navigation button.

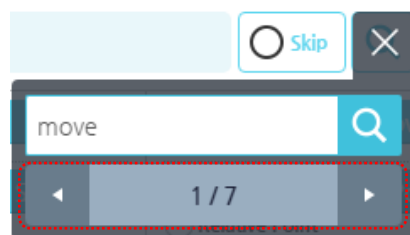

Skipping Commands

For each command created in the program, you can skip without executing a specific command during program execution.

- 1. Check the Skip setting.

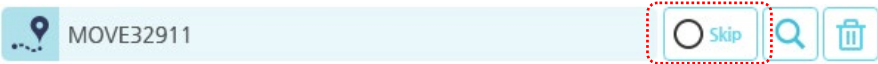

- 2. Commands that have been set to Skip are grayed out, and will not be executed during program execution.

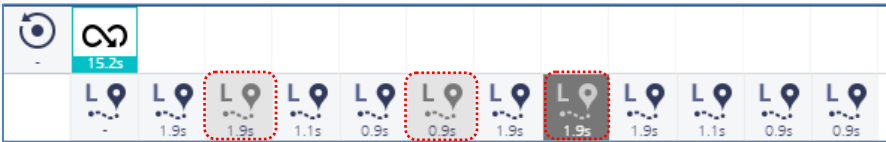

Tree

If you click the **Tree** button, all the commands programmed are displayed in Tree structure. The commands in the Tree and the command icons in the flowchart are displayed in synchronization with selection or program progress.

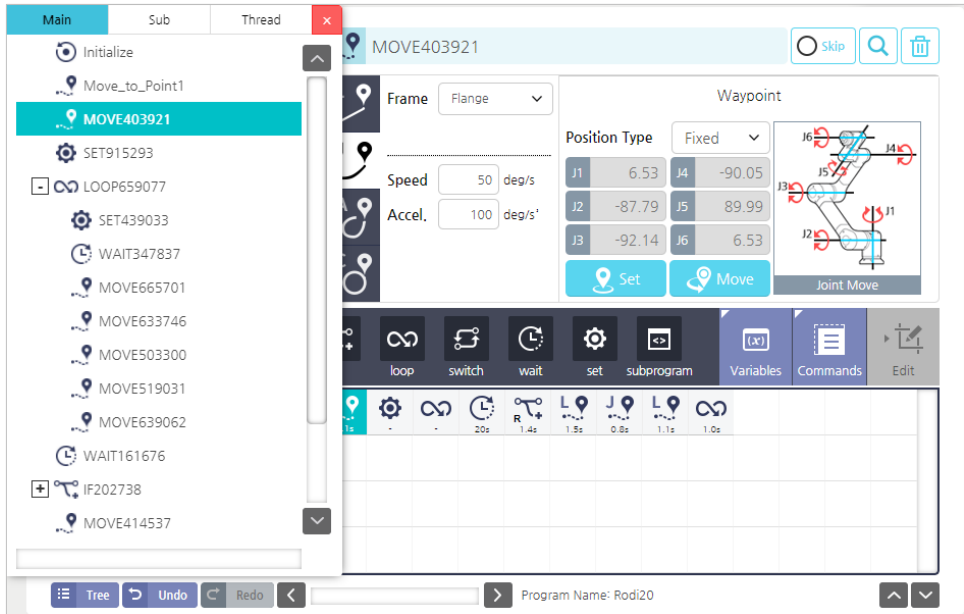

9.2 Setting Variables

You can manage variables such as adding/deleting/modifying variables to be used in the program. Press the variable management menu button at the end of the command list.

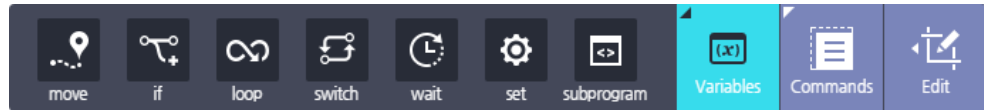

When you press the variable management button, a screen for variable management and monitoring is displayed at the top, as shown below.

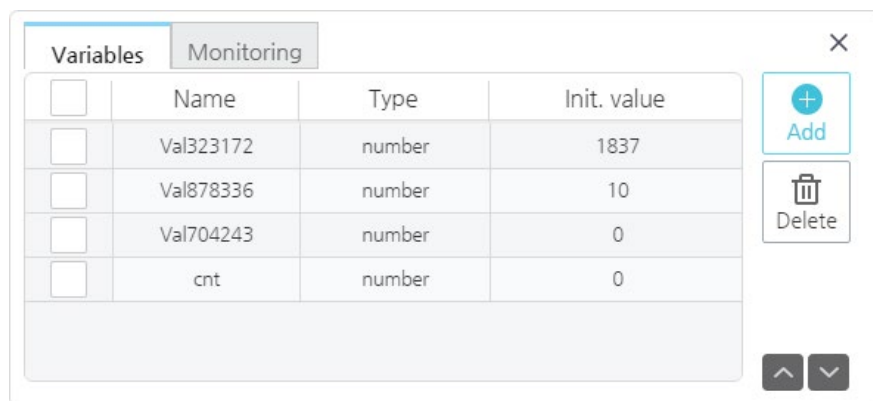

Adding variables

Press the **Add** button. If you press the **Add** button, the default name and value (0) will be automatically entered.

- Number : Variables to store numbers
- String : Variables to store string
- Boolean : Variables of True or False type
- Position : The Position of TCP
- Joint : The Values of Joints
- Array : Array type variables

If you select a variable type, the variable is automatically entered with the default name.

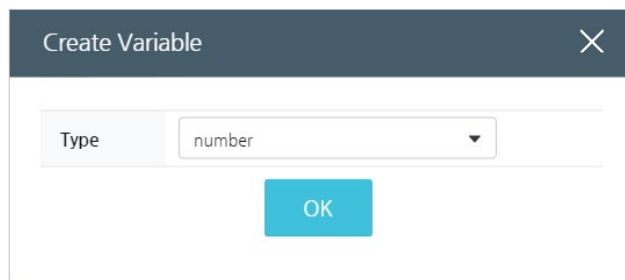

Modifying variables

1. Press the field if you need to change the variable name or value.
2. Change it to the desired name or value and press the **OK** button.
 - The max length of variable is limited to 10 letters.
 - For a variable value, you can only enter a number. The range is from -2147483647 to 2147483647.
 - Character variable's maximum length: 20 characters

Deleting variables

1. Check the checkbox for the variable to delete.
2. Press the **Delete** button and press the **OK** button.

Variable Monitoring

You can check the number of currently registered global variables and the real-time values of variables registered in the robot. Numeric variables are displayed with up to four decimal places, rounded to five decimal places.

Name	Type	Value
g_var_1	number	5
g_var_2	number	41

9.3 Editing programs



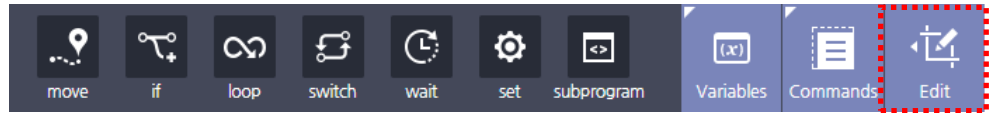



If you want to change the order or structure of commands entered in the timeline, then press the **Edit** menu button at the end of the command list.

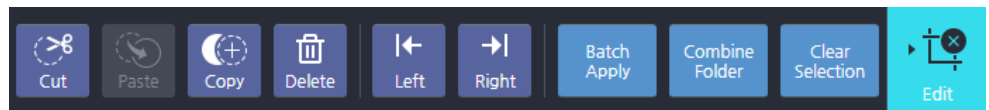

Note You can also press the command in the timeline for more than three seconds to open the **Edit** menu.

Overview of edit menu

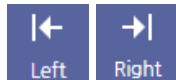
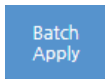
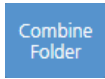
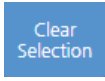

	Cut	Cut the selected command. You can crop a command to another location.
	Paste	Paste the cropped or copied command to the selected location.
	Copy	Copy the selected command. You can copy a command to another location.
	Delete	Delete the selected command from the program.
	Left or Right	Move the selected command to the left or right in the timeline.
	Batch Apply	Applies the values of several selected Move commands in batches. It is activated when you select the same move command.
	Combine Folder	Create a folder at the end of the program and move selected icons below.
	Clear Selection	Cancel the selection of the command.
	Close	Close the program editing mode and return to the program screen.

Example of program editing

In this example, you can cut a command entered in the timeline and paste it onto another location.

1. Select a program command to be pasted onto another location.
 - The red number marked when a command is selected indicates the order of pasting.

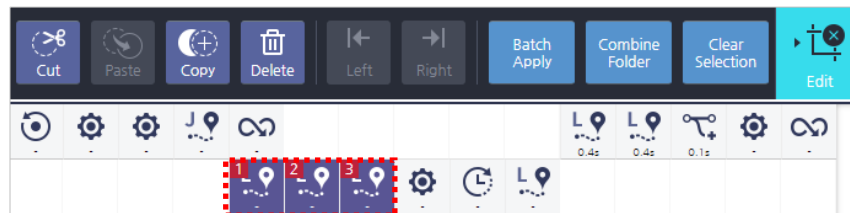

2. In the edit menu, press the **Cut** button.
 - After pressing the **Cut** (or **Copy**) button, the **Select Mode** button will be activated, so that you can cancel the edit command and return to the Select Mode again.

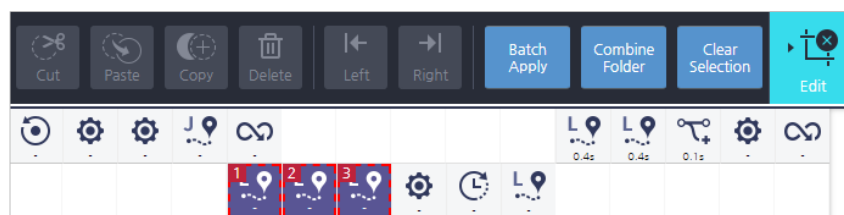
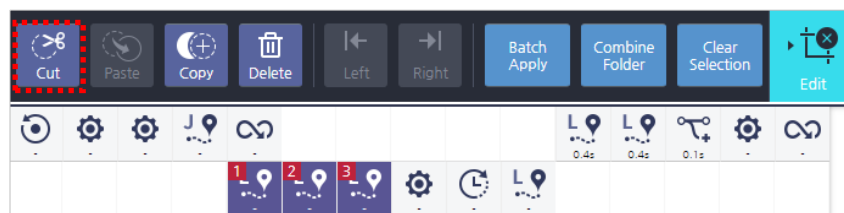

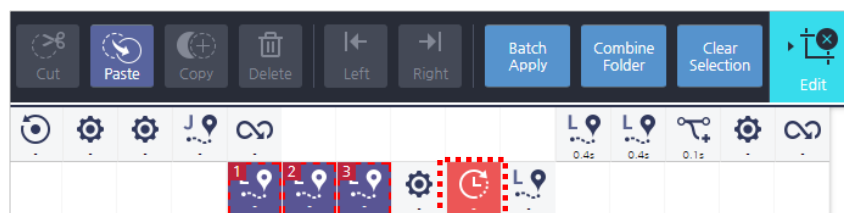

3. Select a location to paste it to.
 - Space between commands cannot be selected, so you must select the command right before the location of pasting.
 - Once a location is selected, the **Paste** button in the **Edit** menu will be activated.

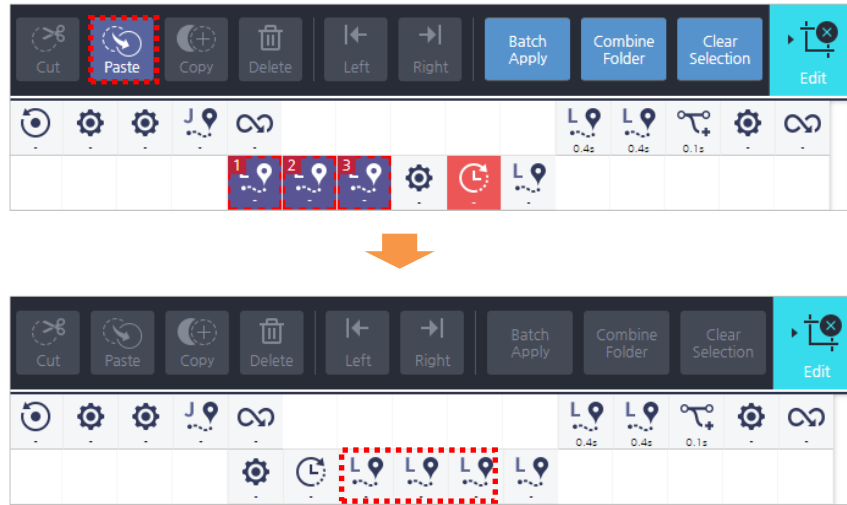

4. Press the **Paste** button.



Undo Function

 Undo	Undo	You can use the edit function to undo edits made to items.
 Redo	Redo	You can redo an edit that has been undone.

Note

- . Up to 50 steps are saved.
- . The edit history is initialized when you open a New File, File Open or Cancel.

9.4 Managing a Program

At the bottom of the programming window, press the **File** button to save, load or delete the program.

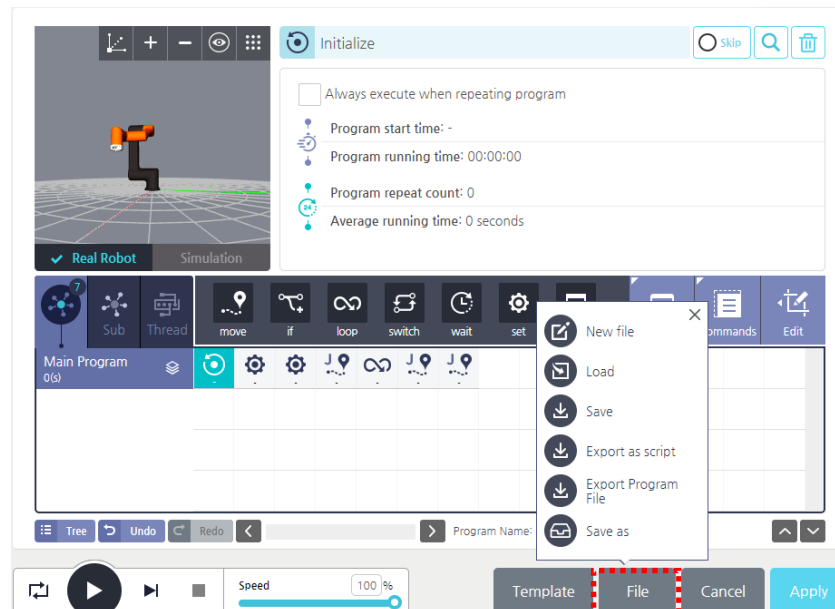

Saving a program

1. To save the completed program, select **File** > **Save** at the bottom of the screen.
2. Enter the program name and press the **OK** button.
 - Only if the program is newly saved or saved with a new name, the name input window will appear.

If you want to save the program with a different name, press **Save as** and enter the name and then press the **Save** button.

Making a new program

If you want to make a new program, then select **File** > **New** at the bottom of the screen.

Note Enter the program name when you apply or save a program.

Loading a program

1. To load the saved program, select **File** > **Load** at the bottom of the screen.
2. Select a program to load and press the **OK** button.

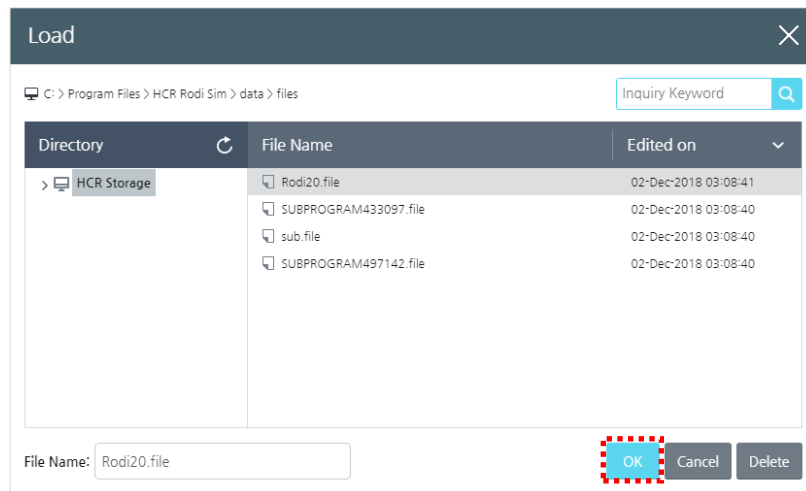

Deleting a program

1. To delete the saved program, select **File** > **Load** at the bottom of the screen.
2. Select a program to delete and press the **Delete** button.

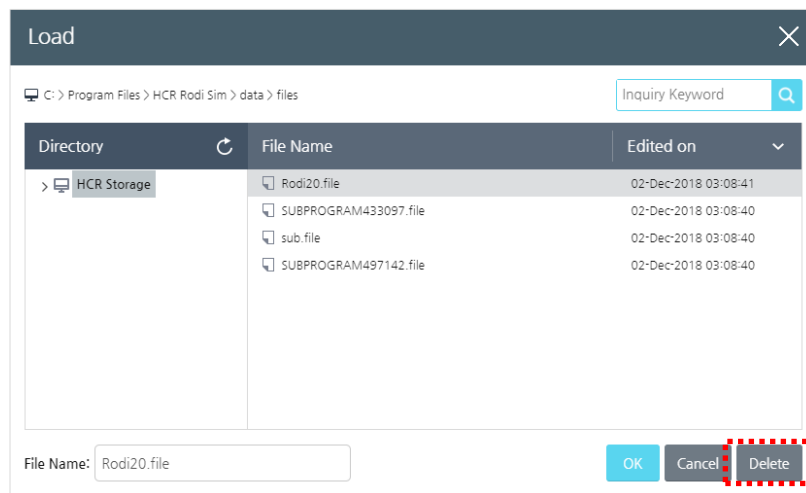

Export as script

1. To save the program as a script, select **File** > **Export as script** at the bottom of the screen.
2. Enter the file name and press the **OK** button.

Export Program File

You can save the program and the configuration file of current system

1. To save the program, select **File** > **Export Program File** at the bottom of the screen.
2. Select a folder to save and press the **Delete** button.

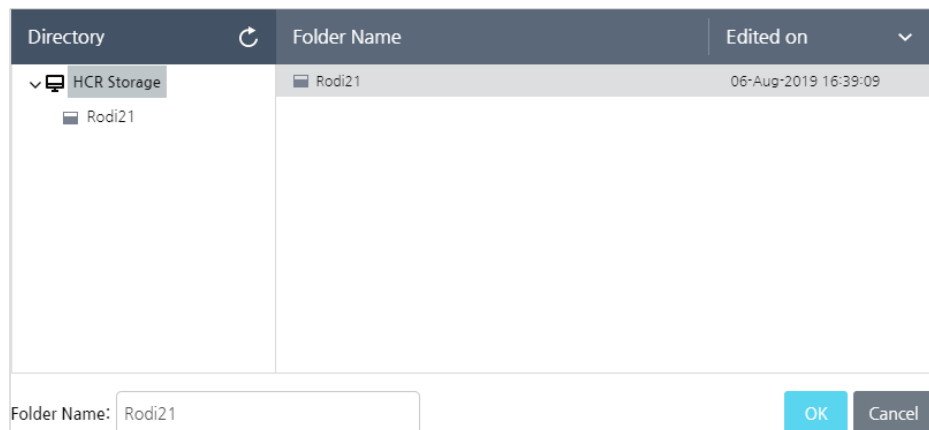

9.5 Using Templates

You can save the prepared program structure as a template. Only the entire program structure is saved but the option for each command is not saved.

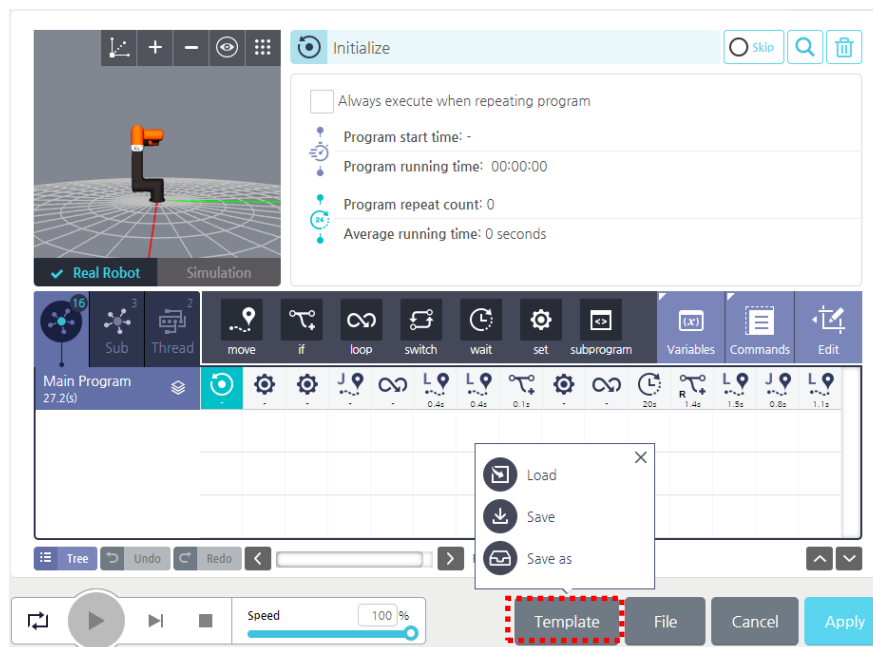

Saving as a template

To save the completed program as a template, select **Template** > **Save** at the bottom of the screen.

If you want to save the template with a different name, press **Save as** and enter the name and then press the **Save** button.

Loading a template

1. To load the saved template, select **Template** > **Load** at the bottom of the screen.
2. Select a template to load and press the **OK** button.

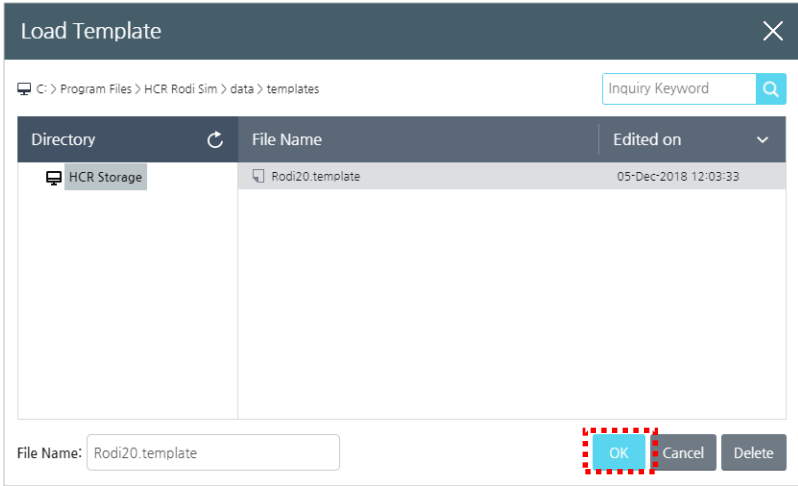

Deleting a template

1. To delete the saved template, select **Template** > **Load** at the bottom of the screen.
2. Select a template to delete and press the **Delete** button.

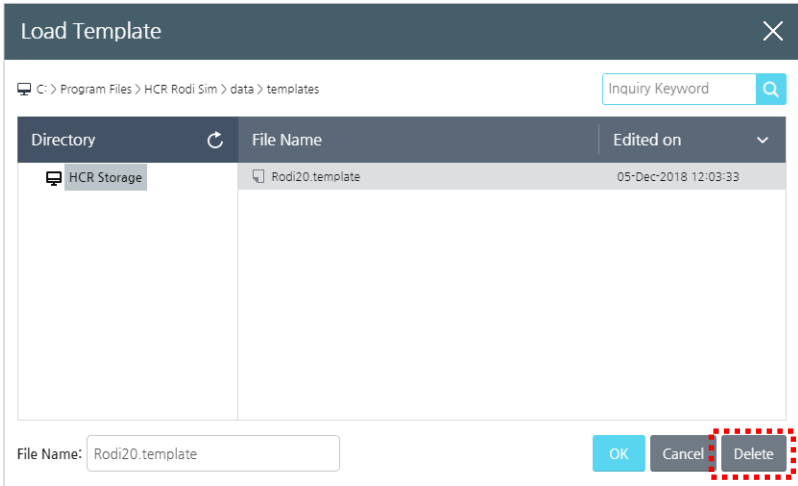

9.6 Applying programs

Before applying the program results to the robot or actually using it, it is necessary to do a simulation.

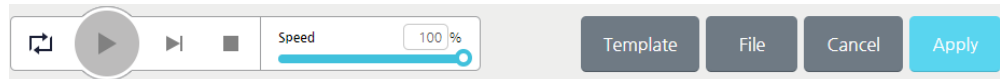

If you want to link the program to an actual robot or check it in previews, press the **Apply** button. To revert it to the previous settings before the changes are made, press the **Cancel** button.



- To check it in preview, select **Simulation**.
- To link it to a real robot, select **Real Robot**.
- The entire program speed can be adjusted by using the **Speed** slide bar.

9.7 Move command

The command is used to move the robot arm by designating the destination and the movement method.

Selecting a movement method

There are three ways to move as follows and you can set the tool speed and acceleration for each method.

- **Linear:** A tool moves linearly between the starting point and the end point. To make the tool movement path a straight line, each joint tends to move in a more complex way.
 - **Frame:** Select whether to move by TCP or Flange.
 - **Reference coordinate system:** Select the reference coordinate system on which the robot moves when executing the move command.
 - **Speed:** 0.1 mm/s ~ 1000 mm/s
 - **Accel. (Acceleration):** 0.1 mm/s² ~ 2500 mm/s²
 - **Don't stop at this point:** This is a setting that allows you to move at a constant speed without stopping operation between move commands. For details, refer to Move without stopping.

Basic		Option		Waypoint	
Speed	500 mm/s	<input type="checkbox"/> Blending		Position Type	Fixed
Accel.	1000 mm/s ²	<input type="checkbox"/> Don't stop at this point		X	489.99
Rotation Count	1	Radius	0 mm	Y	-170.5
				Z	330.88
				RX	179.99
				RY	0
				RZ	-89.99

- **Joint:** The tool movement path between the starting point and the end point is ignored but the movement of joint is minimized, instead.
 - **Speed:** 0.1 deg/s ~ 180 deg/s
 - **Accel. (Acceleration):** 0.1 deg/s² ~ 360 deg/s²

Basic		Option		Waypoint	
Speed	50 deg/s	<input type="checkbox"/> Blending		Position Type	Fixed
Accel.	100 deg/s ²	<input type="checkbox"/> Don't stop at this point		J1	0
Rotation Count	1	Radius	0 mm	J2	-92.48
				J3	-106.51
				J4	-70.99
				J5	89.99
				J6	0

- **Arc:** A tool moves along the circumscribed circle whose center is the circumcenter of a triangle formed by the starting point(S) and the two points (W_1, W_2).
 - **Speed:** 0.1 mm/s ~ 1000 mm/s
 - **Accel.** (Acceleration): 0.1 mm/s² ~ 2500 mm/s²

Note The TCP coordinates of the last position held by the robot are the coordinates of the starting point.

-
- **Circle:** The tool moves along the circle formed by the start point (S) and the two waypoints (W_1, W_2).
 - **Speed:** 0.1 mm/s ~ 1000 mm/s
 - **accel.** (Acceleration): 0.1 mm/s² ~ 2500 mm/s²
 - **Rotation Count:** 1 ~ 50 (Default 1)

Note The starting point is the TCP coordinates of the robot's last posture.

Radius of Linear

If you use the radius in Linear movement and the next command is Linear movement, it moves the curve without stopping when moving between commands.

Basic		Option		Waypoint	
Speed	500 mm/s	<input type="checkbox"/> Blending		X	489.99
Accel.	1000 mm/s ²	<input type="checkbox"/> Don't stop at this point		Y	-170.5
Rotation Count	1	Radius	0 mm	Z	330.88
				RX	179.99
				RY	0
				RZ	-89.99

- The minimum radius is zero. If you set the radius to zero, then its path is not a curve.

Don't stop at this point

This is a setting that allows the robot to move at a given speed without stopping operation between motions. If the currently set move command is Move Linear and the next move command is the same straight line motion, the robot will move without stopping.



- If P1 and P2 are linear motion and the radius is 0, the move commands of P1 and P2 should be on the same straight line with respect to the start position (S), as above.

However, if the set travel command does not reach the set speed or if the next move command is not on the straight line, an error may occur and the robot program may malfunction or not perform.

Blending

Combines with all Move commands to move in series without interruption.

(It doesn't support Move C)

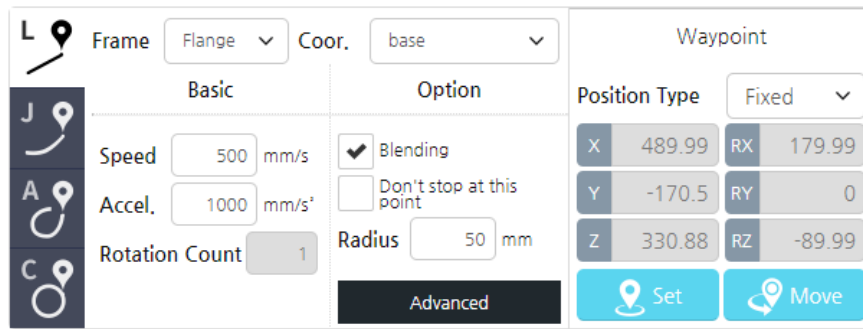

- Select **Blending** (You can't use it at the same time with **Don't stop at this point** function)
- Enter the radius. The maximum radius is calculated based on the coordinates of the next move command as below.
 - Moving path when radius within driving range

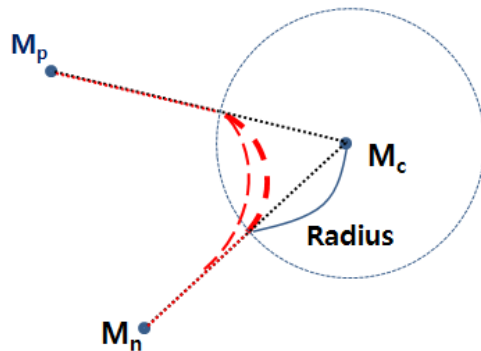

M_p : Start point of blending
 M_c : Waypoint of blending and the center of radius
 M_n : End point of blending

- Limitation of Radius length

The maximum length of the radius that can be set is limited to 50% of the shorter distance between D1 and D2 that is greater than zero.

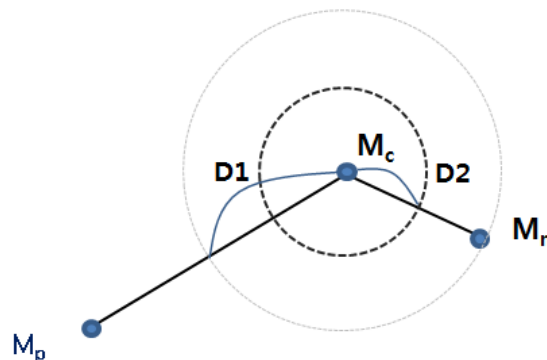

$D1$: (distance M_p & M_c) / 2
 $D2$: (distance M_c & M_n) / 2

Advanced

The command is used to control digital output while moving.

- Select **Advanced**

- Add the digital outputs to control and set the values of them.

Setting the coordinates for movement

To set the movement coordinates, you can either use an absolute value that is fixed in the space or a relative value that is relative to the previous location.

- **Fixed Point:** The 3D coordinate is received from the robot's coordinate system and used as the movement coordinate.
 - Press the **Set** button to launch the **Manual Move** screen. For more details about the **Manual Move** screen, refer to [5.3 Manual Move Screen](#).
- **Relative:** You can set the movement coordinate with respect to the previous location.
- **Variables:** You can set the position variable specified as a local.

Note The inputted coordinate is examined in the control software whether it indicates an area where the robot can move to. Even if you entered an input within the range, an error can occur when the area is prohibited by the safety setting or physical restrictions.

After setting the coordinates, press the **Move** button to move the robot arm to the coordinate where a tool is set.

Displaying as groups

If the move commands are repeated two or more times, then you can use one icon to indicate them all.

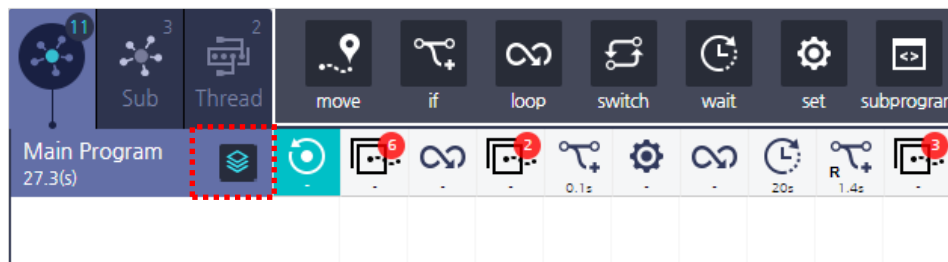

In the flow chart, press the group  button, then they will be grouped as one. The number of commands in a group will be indicated by a number at the right top of the group icon.

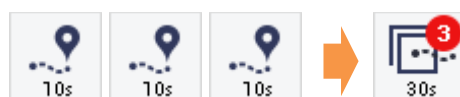

9.8 IF Command

Use the command to initiate different commands depending on the condition.



Enter the condition in an IF statement.



- Press the text box to launch the formula keypad. For more details about the formula keypad, refer to [5.4 Virtual Keypad](#).
- If you use an IF command, an if statement will be created below the main flow.
- Select the **Use Else** checkbox to create an else statement below the if statement.

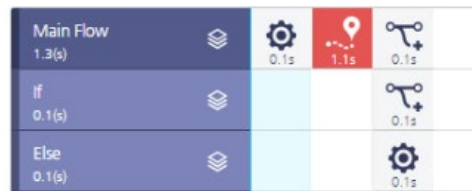

- Add Else IF to add another condition under the if statement.
 - To add Else IF under IF, then press the **+ Else IF** button.
 - To delete the Else IF statement you added, select the checkbox for the Else IF statement, and press the **Delete** button.
- If you select the icon on the right side of the conditional statement as shown below, you can program to check the conditions of the conditional statement in real time.
 - Even if the IF condition is judged to be true, the condition is checked in real time while executing the program. If the condition is False, the execution of the program command is stopped and the upper or lower conditional statement is executed.
 - When If is executed
 - : If Else is present, execute the program command with the Else condition.
 - If Else is not present, execute the next program command of If.

- When ElseIf is executed
 - : If ElseIf is present in the child, execute the ElseIf program command that meets the current condition.
 - If Else is present in the child, execute the Else program command.



9.9 LOOP Command

Use the command to repeatedly execute a series of commands.



- **Disabled:** Do not use a LOOP command.
- **Always:** Repeat execution.
- **Loop input times:** Repeat as many times as the entered number.
 - By default, it is set to one.
 - Max: 1,000,000
- **Execute loop based on input:** Repeat execution until the condition entered by the user is met.

- **Real-time condition check**

Loop condition is judged to be true, and the program corresponding to the condition is executed. When the condition is checked in real time and it becomes False, the executing

command is stopped, the Loop command is stopped, and the next program command is executed.

9.10 SWITCH Command

Use the command to execute a different command depending on each specific case. An IF command is executed after assessing all the conditions branching to Else IF, but a SWITCH command is executed immediately by finding the corresponding case, thus it is much faster than execution of an IF command.

1. Using the drop-down menu next to **Switch**, select a variable.

For more details about the variable setting, refer to 9.2 Setting Variables.

2. Enter a value corresponding to each case.

- To add a Case, press the **+ Case** button.
- To delete the Case you added, select the checkbox for the Case and then press the **Delete** button.
- Click the **Break** button to select whether use the Break property for each Case statement. (Default: Use Break)

9.11 WAIT Command

Instruct the robot to wait for a certain period.

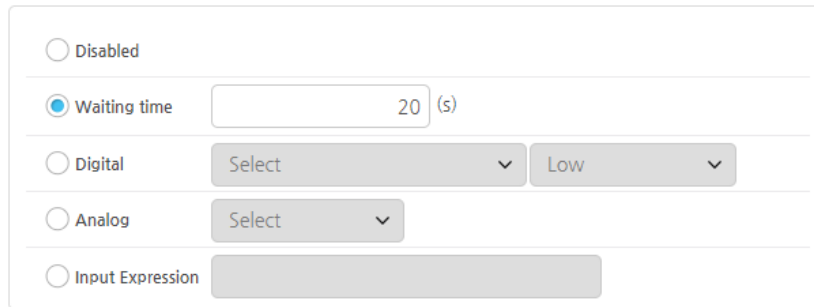

The screenshot shows a configuration panel for the WAIT command. It features five radio button options: 'Disabled', 'Waiting time', 'Digital', 'Analog', and 'Input Expression'. The 'Waiting time' option is selected, with a text input field containing '20' and a '(s)' unit label. The 'Digital' option has two dropdown menus, one set to 'Select' and the other to 'Low'. The 'Analog' option has a single dropdown menu set to 'Select'. The 'Input Expression' option has a large, empty text input field.

- **Disabled:** Do not use a Wait command.
- **Waiting time:** Enter the duration of waiting time.
- **Digital:** Wait until a digital signal is inputted to a specific digital input terminal.
 - For a digital signal, you can choose either of low or high.
- **Analog:** Waits until the condition of the value set to a specific analog input terminal is met. On analog setting, whether to use the current (A) or the voltage (V) is determined by the unit set under the Monitoring menu.
- **Input expression:** Wait until the conditional expression set by the user is met. You can enter the conditional expression indicating the waiting condition on your own.

9.12 SET Command

You can set a digital or analog output value or assign a specific value to a variable or even change the TCP profile currently in use.

The screenshot shows the SET Command interface with the following options:

- Disabled (with a Test button)
- I/O**
 - Digital: D_CONF_OUT_0 (dropdown), High (dropdown)
 - Analog: Select (dropdown)
 - Tool Power: 0V (selected), 12V, 24V

- **Disabled:** Do not use a SET command.
- **Digital:** Set a specific digital output value.
- **Analog:** Set a specific analog output value. The output unit is based on the analog unit that you set in the Monitoring menu.
- **Tool Power :** Set the voltage of Tool IO Power.
- **Test :** Test defined output before running program.

The screenshot shows the SET Command interface with the following options:

- Disabled (with a Test button)
- I/O**
 - Variable: g_var_1 (dropdown) = Assignment (dropdown)
- Var**
 - Message: 21
- TCP**

- **Variable:** Assigns a specific value to a variable added to the variable list and to a register item set in the MODBUS TCP menu. Press the text box next to the variable selection menu to launch the expression keypad. For more details about the expression keypad, refer to [5.4 Virtual Keypad](#).

The screenshot shows the SET Command interface with the following options:

- Disabled (with a Test button)
- I/O**
 - Set TCP: Select (dropdown)
 - Set the payload: 0 lb
- Var**
 - Use active TCP as center of gravity
- TCP**

- **TCP:** Switch to another TCP profile.
- **Payload:** Change the payload of current TCP.

9.13 Folder

Program command icons can be grouped into folders.

Change Programed Icons Into Folder

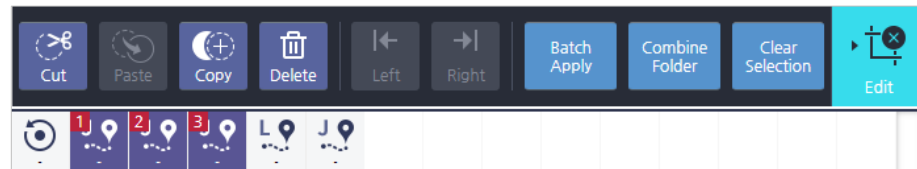

1. Click the Edit icon.
2. Select icons that you want to group into folder.
3. Click the Combine Folder icon.
 - When converting a folder, the folder is created at the last location of the program.

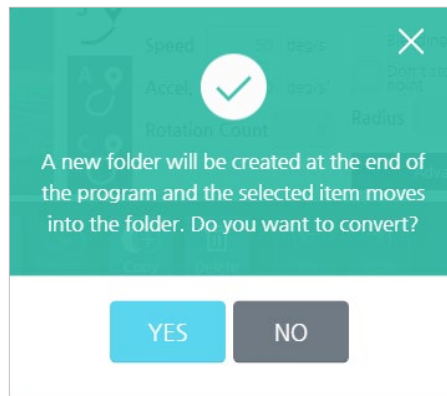

Create New Folder

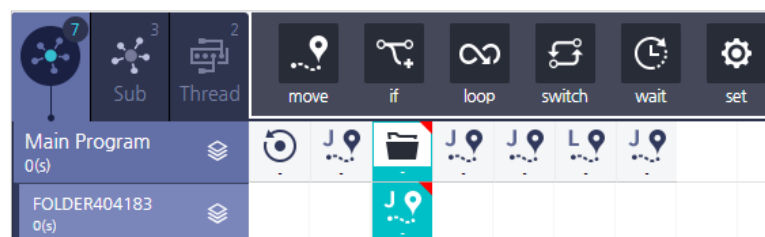

1. In the Commands view, click the Folder icon to create a folder.
2. Add icons to be programmed under the created folder.

9.14 Message

Displays a user-defined statement or variable in a pop-up or console window.

The command can be added from the Command Extension tab.

The image shows a configuration window for a message command. It has two main sections. The first section, 'Message Type', contains two dropdown menus: the first is set to 'Pop-up Message' and the second is set to 'None'. The second section, 'Message Output Type', contains two radio buttons: 'User Message' (which is selected) and 'Variable Output'. To the right of the 'User Message' radio button is a text input field and a blue 'Select message' button. To the right of the 'Variable Output' radio button is a grey 'Select' dropdown menu.

Output format

- Pop-up: Displays a pop-up window with messages.
- List: Displays messages in the lower left console window.

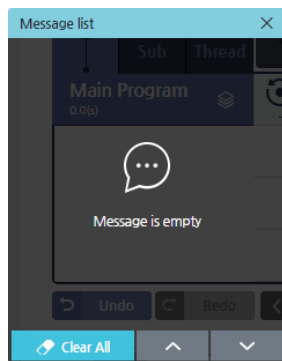

Message operation

If you set the message format as pop-up, you can specify the operation accordingly.

No operation / Pause / Stop

- If pause is set, you can select whether to continue the program from the popup message.

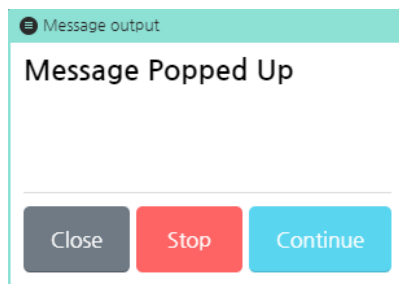

Message format

- User message: Outputs the message the user has entered.
- Variable output: Selects the variable to which to output the value.

Select message

- Write a message in advance and save the text file to the USB in UTF-8 format.
- Click **Select message**.
- Select the created message file and click **OK**.

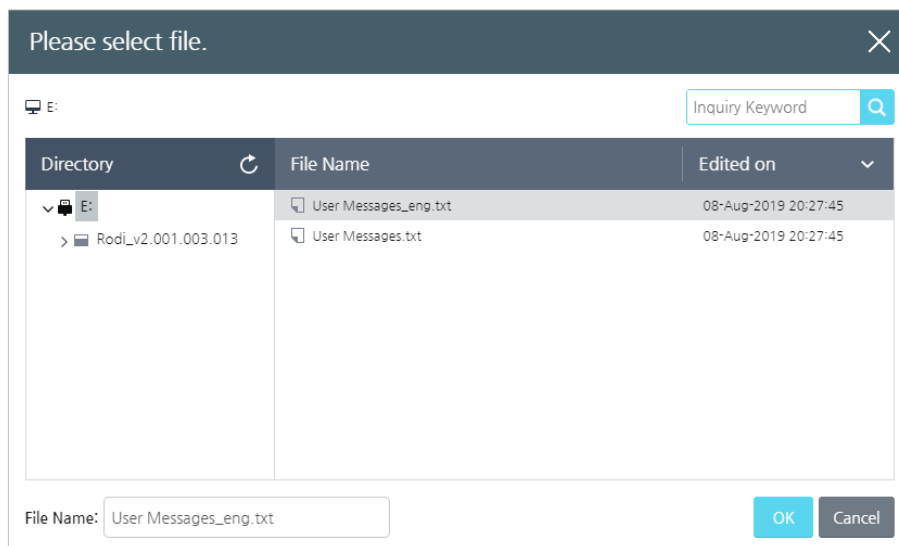

- Select the message to use and click **Apply**.

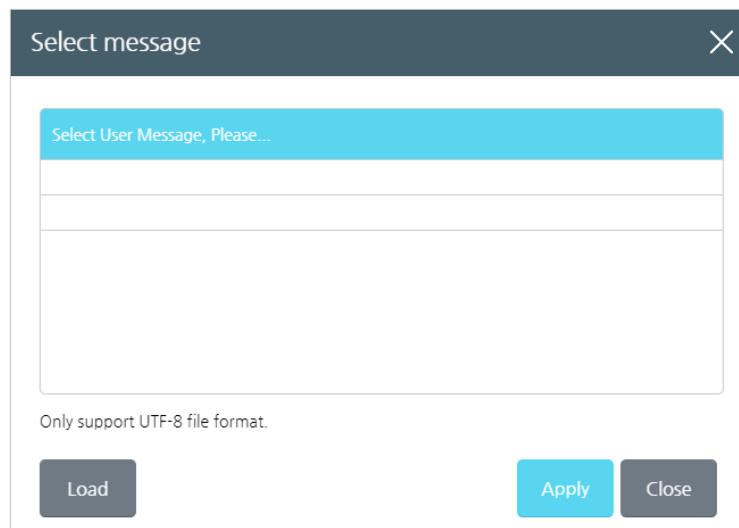

9.15 PATTERN Command

If the robot repeatedly executes the same task along the same path, you can define it as a pattern by using this command.

Pattern types

There exist the following five types of patterns.

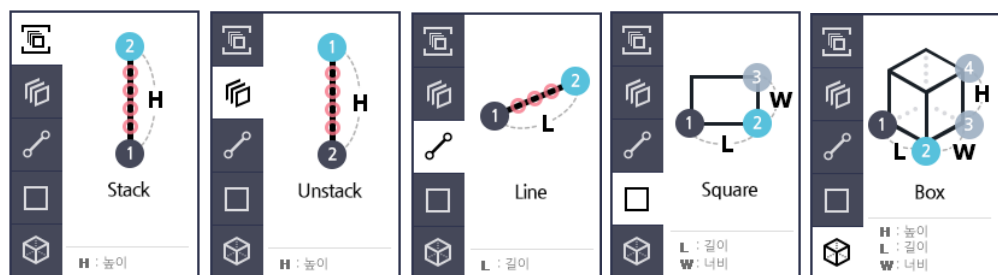

- Stack pattern: In this pattern, the robot stacks objects while vertically moving with certain intervals.
- Unstack pattern: In this pattern, the robot unstacks objects while vertically moving with certain intervals.
- Line pattern: In this pattern, the robot repeats the same task while moving along the straight line with certain intervals.
- Square pattern: In this pattern, the robot repeats the same task while moving along the straight line and in the direction perpendicular to it.

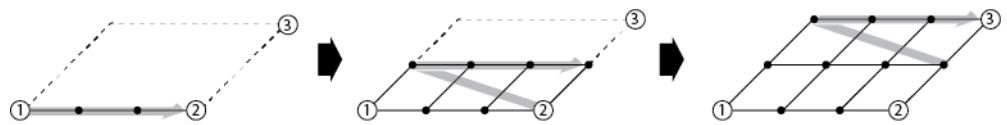

- Box pattern: In this pattern, the robot also repeats the same task vertically which it performs in a square pattern.

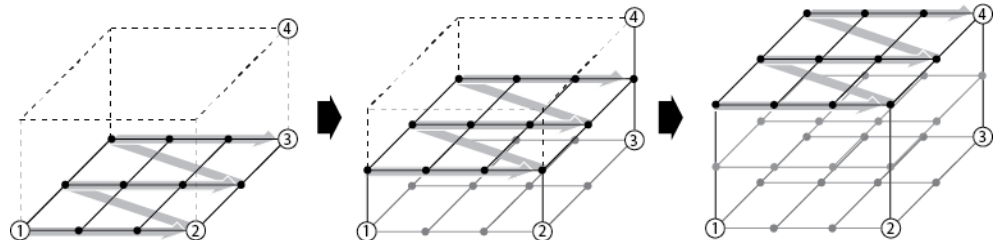

Setting the pattern coordinates

After selecting a pattern to use, set the coordinates that determine the type of pattern. The following image illustrates a box pattern.

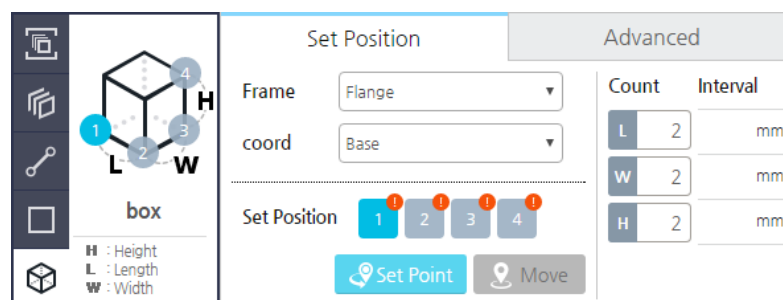

1. Select the coordinates to set by starting with number 1.
 - Select the number for the sample image or press the list of the **pattern location coordinates**.
2. Press the **Set Point** button.
 - Press the **Set Point** button to launch the **Manual Move** screen. For more details about the **Manual Move** screen, refer to [Manual Move Screen](#)
 - On the **Manual Move** screen, enter the final coordinate values.
3. Proceed with point setting until you reach the last number.

Setting repeat counts

For every pattern, you need to set repeat counts between the starting point and the end point on each side.

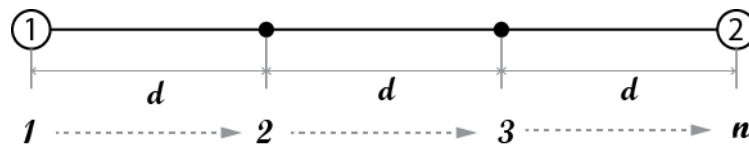

- **Count (n):** the number of repeated movements on a side
- **Interval (d):** the distance that the robot moved each time

Note

- If you do not enter the coordinates, the repeat count or the interval will not be displayed.
- When the repeat counts are set, the intervals are automatically calculated and displayed. The intervals are not editable.

Advanced commands for patterns

Sets the display of the currently executing index of the pattern, the moving index using the variable, and the starting position.

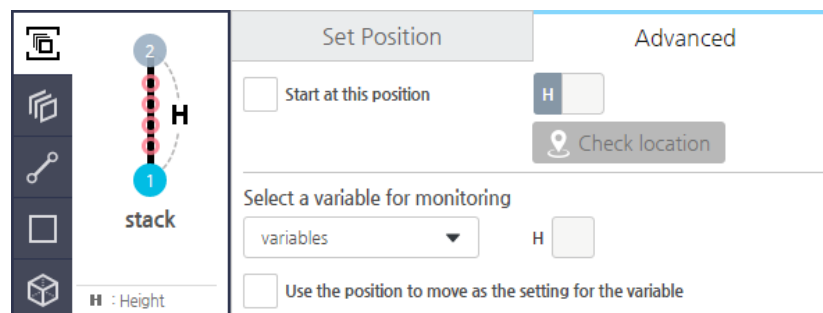

- **Setting the start position:** If 'Start at the Next Position' is checked, the start position is set at the initial position of the pattern.
- **Location verification:** While pressing this button, move to the position you entered.
- **Monitoring variables:** If you want to know the current running index of the pattern, you can use a numeric variable to monitor for the current moving index.
 - Starting index: 0 Base
 - After executing the pattern, the monitoring variable is automatically increased by 1.
- **Set a variable to use the position to move.**

: Used to move to a specific position using a variable.

Variables are used together with monitoring variables.

If starting position and variable movement are used together, starting position is given priority.

Setting pattern points

If you enter a pattern command in the timeline, then the line to set the pattern point and the  icon will be added. When each pattern repeats, if you immediately move to the next destination, then you can get interfered by an obstacle. So, by using the pattern point setting, you can avoid collisions with them and smoothly continue with the next pattern task by selecting a desirable tool path.

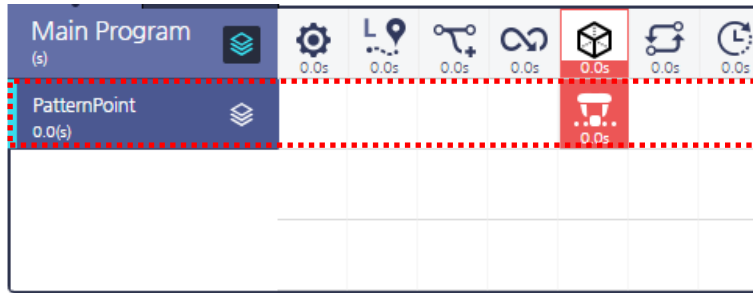

Press the pattern point  icon to launch the following setting screen.

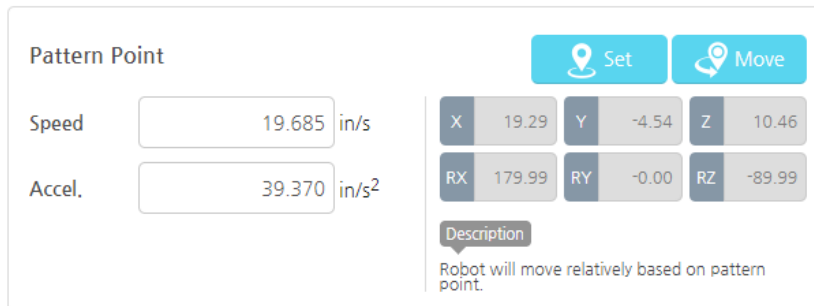

The options for the pattern point settings are the same as the linear movement options in the move command section, and additionally you can insert move commands before and after the pattern point to adjust the tool path.

Note Only a linear type of move command can be used before and after a pattern point.

9.16 Using a Sub Program

In the main program, you can call multiple sub programs for use.

Making a sub program

1. In the flow chart, press the **Sub** tab.

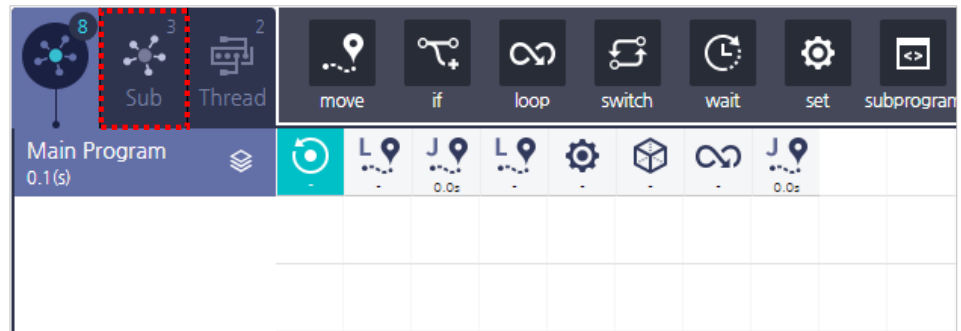

2. Press the **subprogram** button in the command menu of the **Sub** tab.
 - Once the **subprogram** button is pressed, a new sub program will be created.
 - The name of the sub program is automatically generated.
 - To delete the sub program, press the **Delete** button at the top or press the **Edit** > **Delete** button.

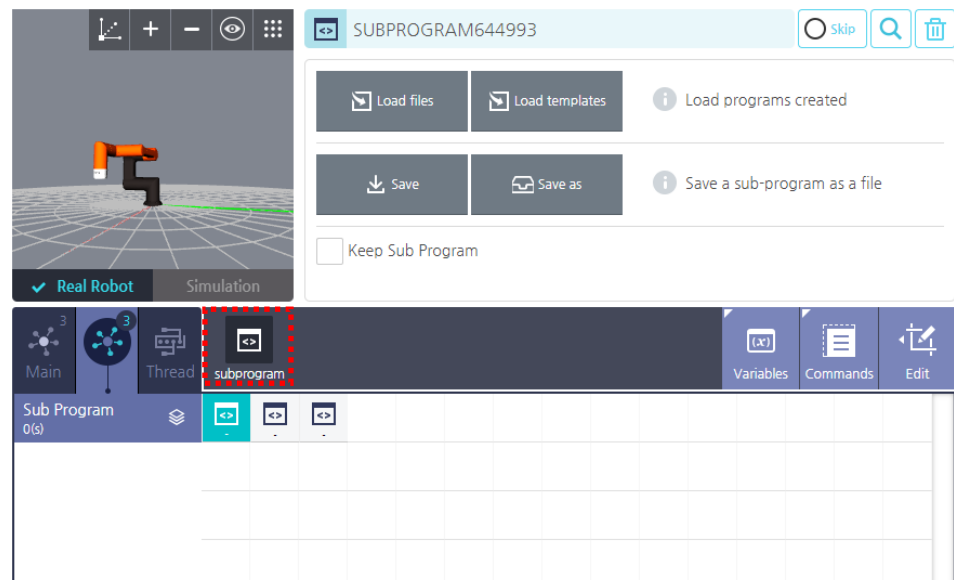

3. After pressing the sub program, create a program that will be used as a sub program.
 - Once the sub program is pressed, available commands will appear in the command menu and a time line will be created, so that you can prepare a program.

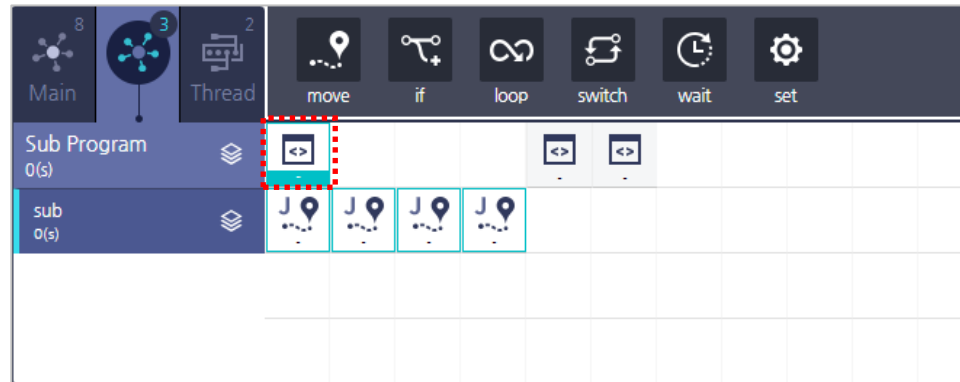

Saving and loading a sub program

After creating a sub program in the **Sub** tab, you can save it as a file or load the sub program or template.

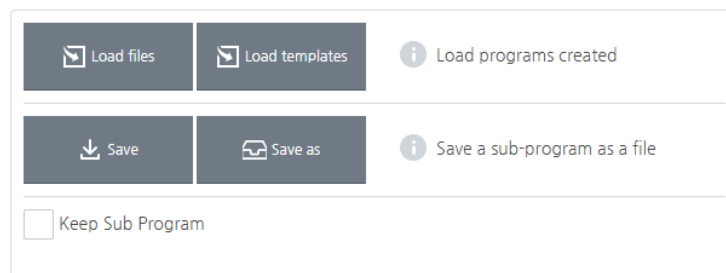

- **Keep Sub Program** : Even if the original subprogram is changed, the contents of the program at the time of loading can be preserved, and even if modified by another program that shares the subprogram, the operation at the time of loading the subprogram can be preserved without being affected.

Entering a sub program

After creating and saving a sub program in the **Sub** tab, proceed as follows to use it in the main program.

1. Enter the **subprogram** command in the main program.



2. Press the **Sub-program** button.
 - After selecting a sub program, the sub program name will be displayed on the button.

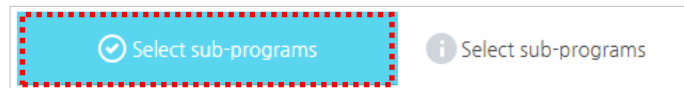

3. Select a sub program for use and press the **Select** button.

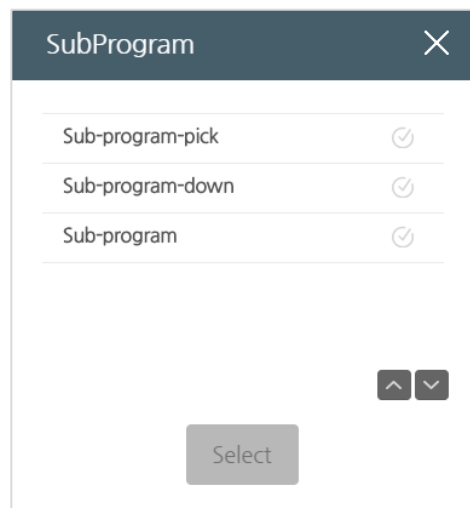

Once a sub program is selected, the **subprogram** command will be added to the timeline as shown below, and a sub program line will be added at the bottom to indicate the content of the sub program.

In the main program, you can also modify the content of the sub program. Since the sub programs in the main and sub tabs are linked to each other, modification made in one of them will be also reflected in the other.

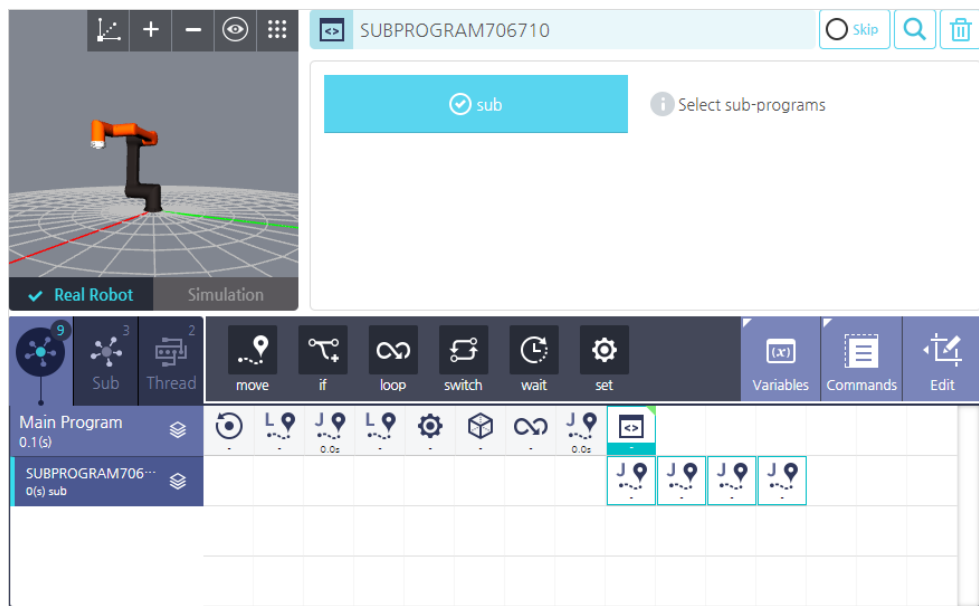

Note In the main program, you can modify the content of sub program but you cannot save it. If you want to save modifications made for the sub program in the main program, you must save it in the Sub tab.

9.17 Conveyor

Executes operations linked with conveyor movement.

Conveyor Setting

Conveyor Setting	
Direction	Direction <input type="button" value="v"/> Position offset <input type="text" value="0"/> in
Conveyor Speed	Direct Input <input type="button" value="v"/> <input type="text" value="0"/> in/s

- **Direction** : Set the conveying direction information of the conveyor. Select the line coordinates created from the coordinate settings.
- **Position offset**: Set the distance to delay tracking start.
- **Conveyor Speed**: Set the conveying speed of the conveyor. Select the Number variable or type the value directly.

Conveyor Start Options

If the I/O set in the trigger satisfies the condition, it starts tracking the conveyor.

Conveyor Start Options

Trigger =

- **Trigger** : Set the I/O and condition that trigger the start of conveyor tracking. Only Digital Input is available.

Setting Conveyor Command

Set the actions to be executed during conveyor tracking.

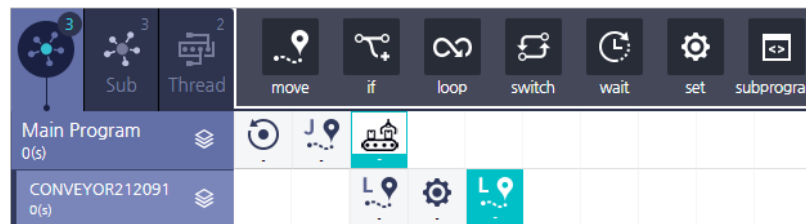

- During conveyor tracking, the robot moves to the Move position specified by the conveyor moving direction. Only Linear Move can be set in the conveyor.
- The real-time monitoring function of If and Loop can not be set for operation during conveyor tracking.
- Conveyor tracking is finished when all work in the conveyor tracking is complete.

9.18 VISION Command

You can communicate with a vision equipment by using the vision data configured in the **Device Setting** menu.

Setting basic options

Press the drop-down menu to select a desired vision equipment and set the waiting time and the data receiving option.

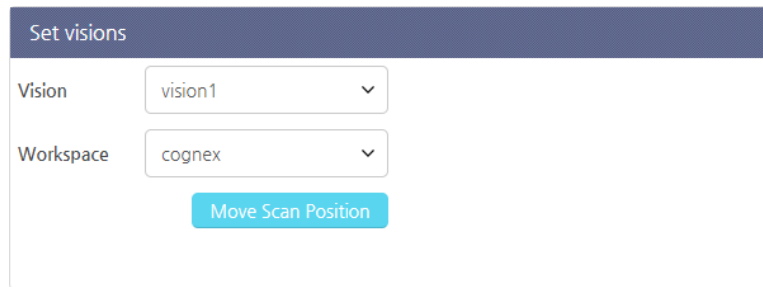

Setting the movement speed

Once you have entered the **vision** command, a vision capture point  and a moving point will be created below the vision command.

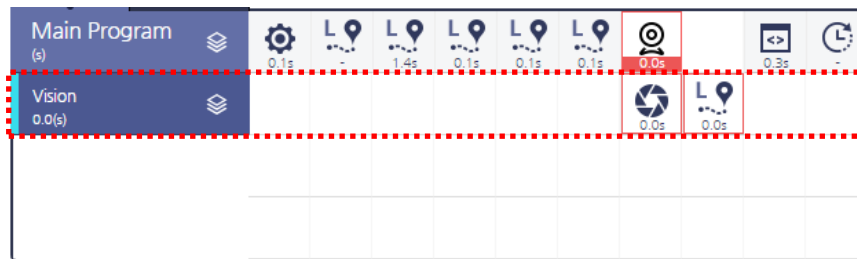

You can set the vision capture point  on the following screen.

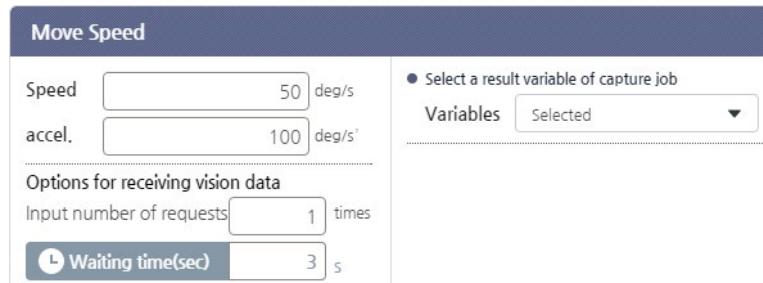

You can set the movement speed/acceleration for a vision camera attached in the robot to move to the recording location.

- The same input range of speed/acceleration is used as in linear movement.
- Variable setting: If there is a variable registered by the user, it can be used to store whether to recognize the vision. If you select a variable, it stores the success or failure during program execution, and you can program it using the corresponding variable in the next program. Conversely, if you do not select a variable, when the vision fails, the program will not proceed any further.
- Since the **scan position** is configured in the **Device Setting** menu, you do not need to set it in the vision command again.
- **Wait time(s)**: After a vision equipment moves to the recording location, it may require some waiting time until the robot arm's position is stabilized. (No waiting time is required depending on the robot speed.) Set the waiting time for responses after requesting data from a vision equipment.
 - Default: 3 sec
 - Input range: 1 ~ 10
- **Read and Fail Options**: You can set the number of data requests in case data receiving is unstable.
 - **Request only one time**: Request data only once. (Default)
 - **Request count**: The input range is 2 ~ 10.

Setting the movement location

After a vision equipment arrives at the location, you can use an additional Move command to adjust the Z-axis for the TCP. You can use a Move command under a Vision command as follows.

Move Speed		Set Move Point(Z)	
Speed	<input type="text" value="50"/> mm/s	<input type="text" value="441.50"/> mm	<input type="button" value="Set Point"/>
accel.	<input type="text" value="100"/> mm/s ²		

- The same input range of speed/acceleration is used as in linear movement.
- The X, Y coordinates and the RX, RY, RZ coordinates used are received from a vision equipment and only the Z coordinate can be set to user's preference.

Note If you want to use a tool such as a griper, you will need to input the **set** command additionally.

9.19 Thread

When a robot program is executed, it is possible to execute parallel programs that require IO and other controls in parallel with the Main program. However, Move-related commands cannot be used.

Thread Tab

Select the Thread tab to create a thread. Click the drop-down menu to select the vision device you want to use, and set the wait time and data reception options.

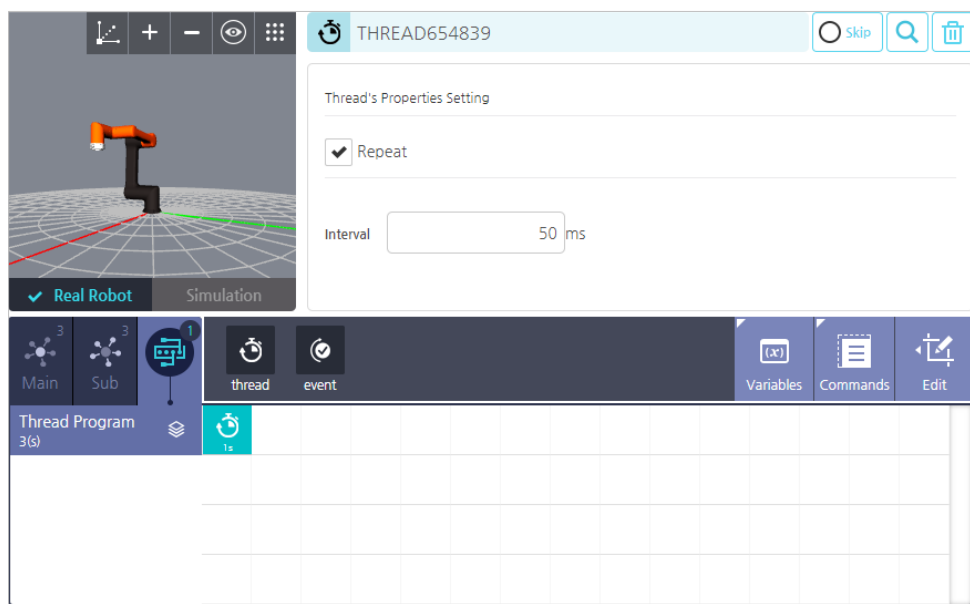

- **Repeat:** Selects whether to repeat the program. If it is not checked, thread will be executed just once.
- **Interval:** Set the execution interval.

Thread Creation

Multiple threads can be created. Like a sub-program, each Thread is clicked on as an icon and added to the timeline in the lower layer.

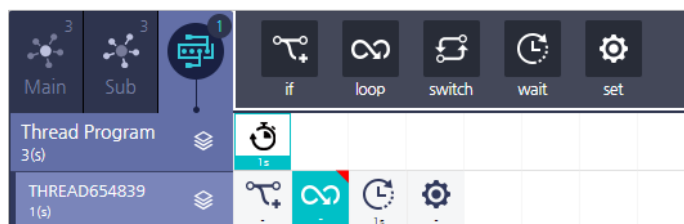

Note Commands to control the motion of the robot cannot be used.

Event Tab

Create Thread which has condition. Select the Event tab to create a Event.

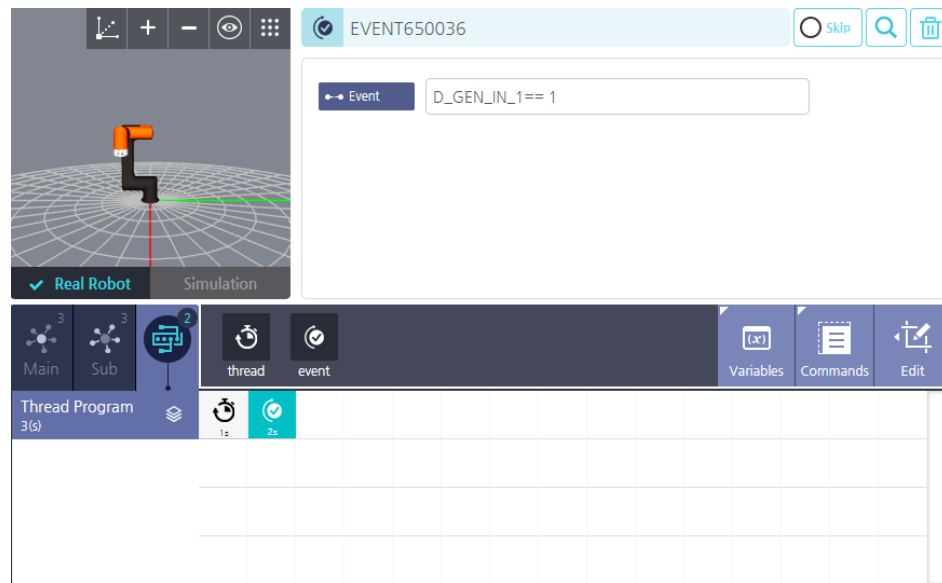

It's same with Thread except using condition.

9.20 Script

Provides the function to edit the robot script and set it as a robot command.

Script Viewer

Displays a created script. While the program is running, a line currently proceeding in real time is displayed on the screen.



- **EDIT:** You can edit the edit window by opening it.

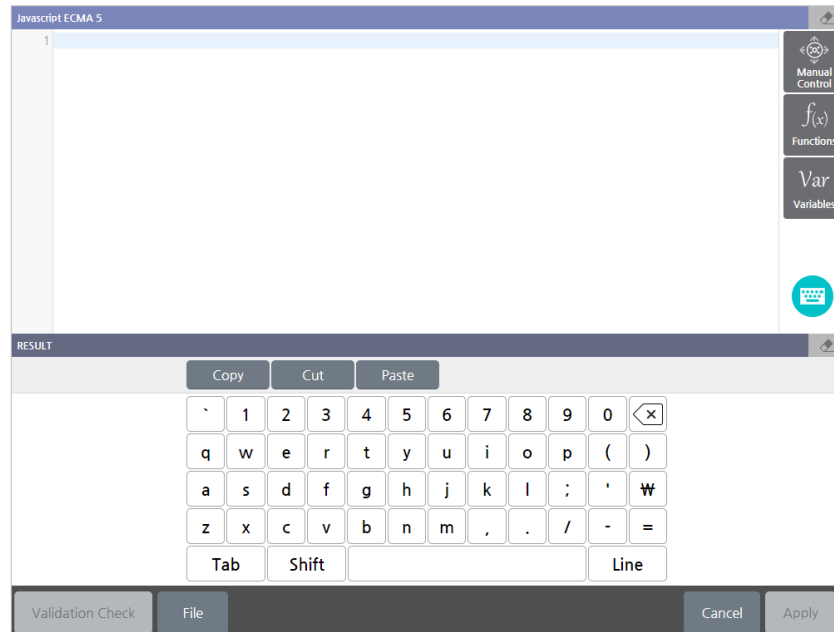

- Click the Validation Check button to check the integrity of the created script.
- Manual Control: Operate the robot manually and get the coordinates of TCP, Flange, and Joints.
- Functions : Available functions can be added to Script by clicking on them.
- Variables: Available variables can be viewed and used.

Note For script commands, refer to the separate manual.

9.21 Path Command

You can create a motion by holding the robot arm directly.

Recording Paths

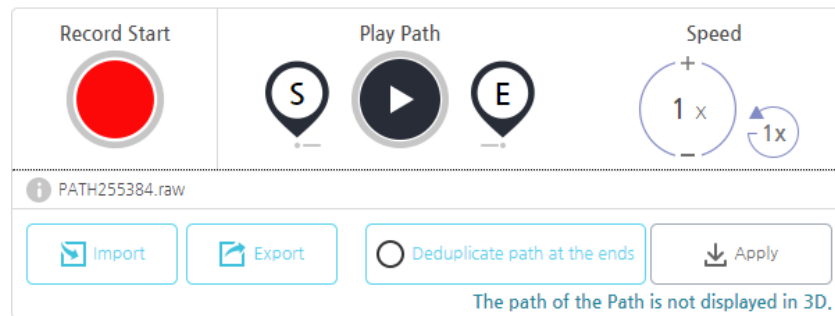

1. Starting to record

Click the button and move the robot arm along the path you want to record.

During recording, the recording status is displayed in a pop-up window, and can be canceled or stopped.

During recording, you cannot move to another screen or perform other operations.

If an already created path is found, it will be deleted and a new one created.

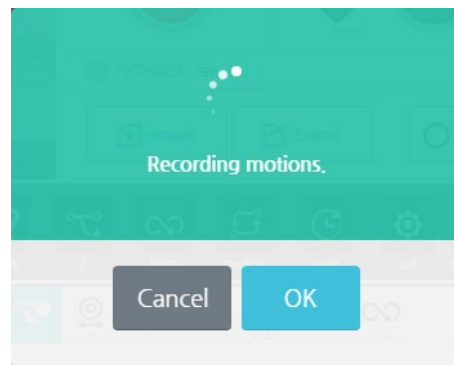

2. Path Playback

If there is a recorded path, it will perform its motion.

- S: Move to the beginning of the path.
- E: Move to the end of the path.

3. Apply

Once you have confirmed the motion, click the Apply button to save it as a file.

- Speed: Sets the execution speed of the recorded motion.

- Import: Imports an already recorded motion.
- Export: Saves the recorded motion separately.
- Deduplicate path at the ends: If there are the same postures at the start and end points in the motion recording process, they are deleted.

Note To execute the recorded motion, the Move coordinates immediately before the Path command and the start coordinates of the Path must match. Press the S button to move to the start position, and match it with the coordinates of the previous Move command.

Chapter 10 Starting the Robot

Starting the robot means that you are powering up the servo motor and get ready for its operation.

Select  **Robot Operation** in the main menu.

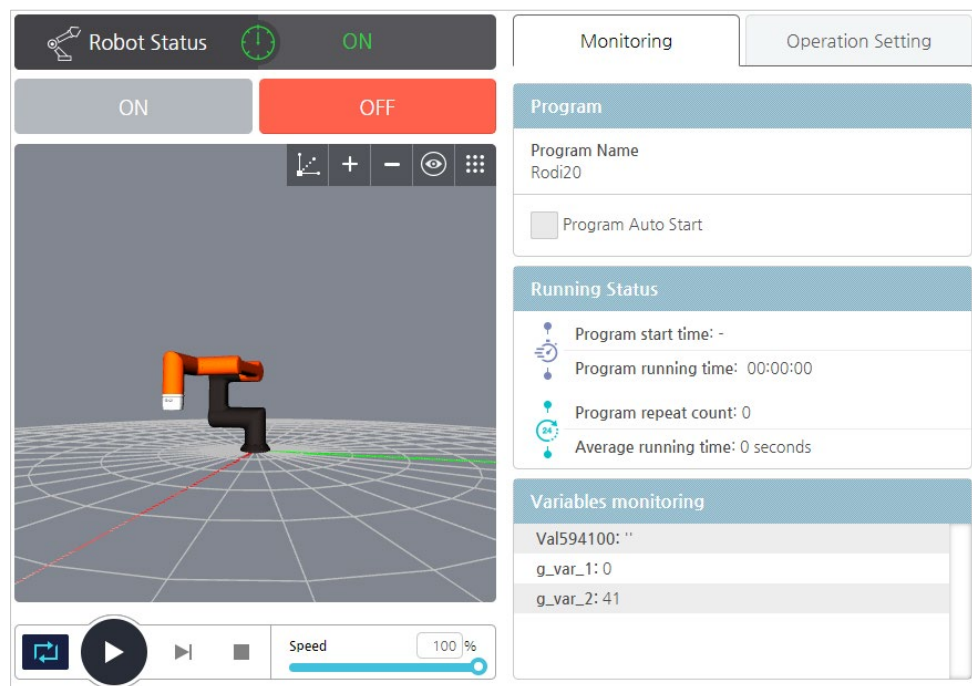

Note If your robot is already registered, then it will appear in the initial screen after booting up the system.

Turning ON/OFF the robot

You can check the start/end status of your robot at present, and turn on or off the robot.

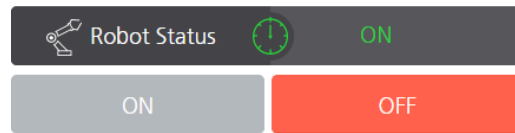

- ON:** Power up the motor for the robot joints and get ready for robot operation. If the robot status is **ON**, then the **OFF** button will be activated and the **ON** button will be deactivated.
- OFF:** Power off the motor for the robot joints and enable robot operation. If the robot status is **OFF**, then the **ON** button will be activated and the **OFF** button will be deactivated.

Monitoring

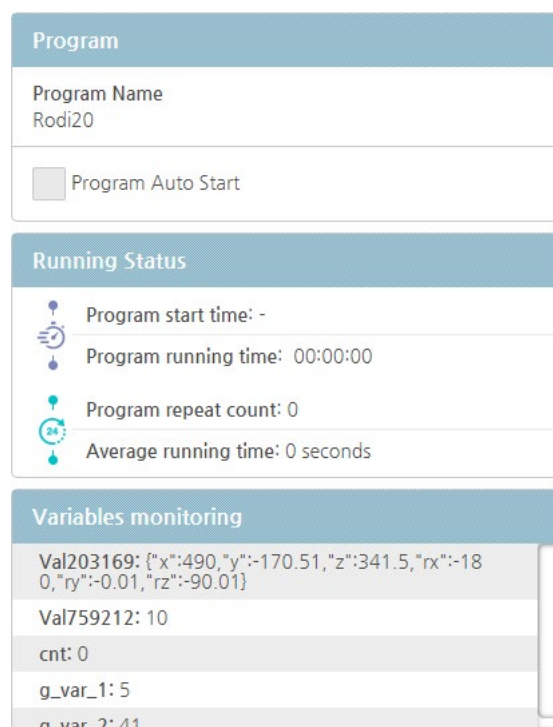

- Program Name:** Indicate the name of current program loaded.
- Program Auto Start:** It is activated when setting the program auto start condition at system startup **Managing the Robot System Configuration**. For details on the settings, refer to [16.5 Managing the Robot System](#).
- Variable Monitoring:** Displays the name and current value of the variable being used.

Checking and setting the robot operation data

You can check the effective weight applied to the currently selected robot and quickly retrieve the saved robot settings and program and apply them to the system.

The screenshot displays a control panel with the following sections:

- Buttons:** A blue "Reset" button and a green "Use safety limit check" button with a checked checkbox.
- Active TCP:** A section showing coordinate values for X, Y, Z, RX, RY, RZ, CX, CY, and CZ. The X, Y, Z, and CX, CY, CZ values are 0, while RX, RY, and RZ are 0.00. A "Payload 0 lb" indicator is also present.
- Load Robot Configuration:** A dropdown menu with the text "Please select a setting file." and an "Apply" button.
- Tool Power (Voltage):** Three radio button options for 0 V, 12 V, and 24 V.
- Program Selection:** A dropdown menu with the text "Please select a program file." showing "Rodi20.file" selected, and an "Apply" button.

- **Reset:** If the robot is malfunctioning or uncontrollable temporarily then initialize the controller.
- **Use safety limit check :** Enables/disables menu's safety settings.
- **Active TCP:** Indicates currently set TCP information.
- **Load Robot Configuration:** A user can load a robot configuration file exported to a local storage. For more details about how to export robot settings, refer to [15.5 Managing the Robot System Configuration](#) .
- **Tool Power(Voltage):** Set the Power of Tool IO.
- **Select Robot Program:** You can select one of the program files stored in a local storage and quickly apply it to the system.

Operating the robot

If you want to operate your robot according to the program selected in the operation setting, then press the  button in the preview window. For more details about the preview screen, refer to [5.2 3D Preview Screen](#).

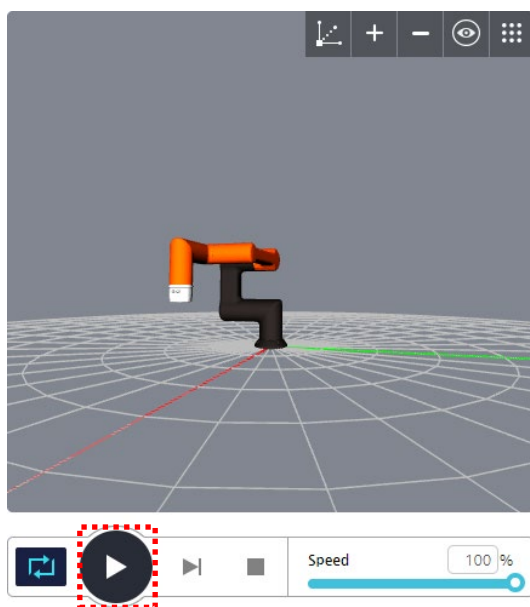

If the current coordinates of the robot are different with the start coordinates of the program, a pop-up window will be displayed for confirmation.

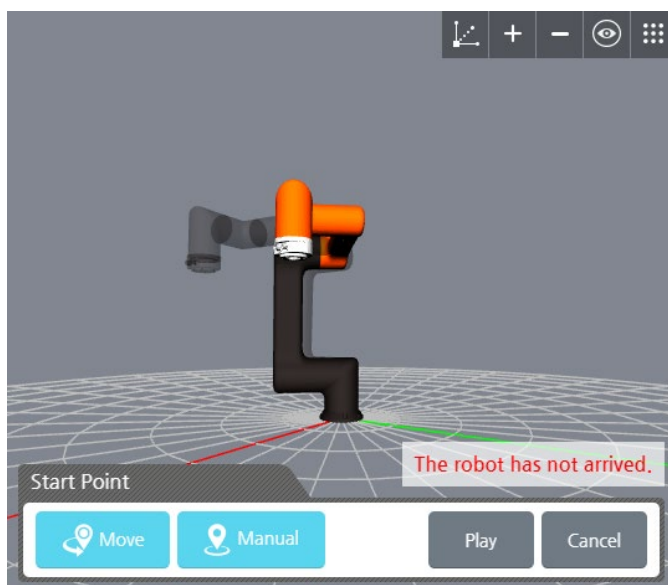

If there is an obstacle at the start of the current coordinate and there is a possibility of a collision, you can check it and move the robot to the safety position and start.

- **Move:** Move robot to start position.
- **Manual:** Manually move robot through the manual contro.
- **Play:** Start program from current position. If the robot is not at the start position of the program, it moves to the start position and the program starts.
- **Cancel :** Cancel Playing program.

Locking Screen

Restricts the operation of the screen during program execution. All operations except screen lock button are restricted.

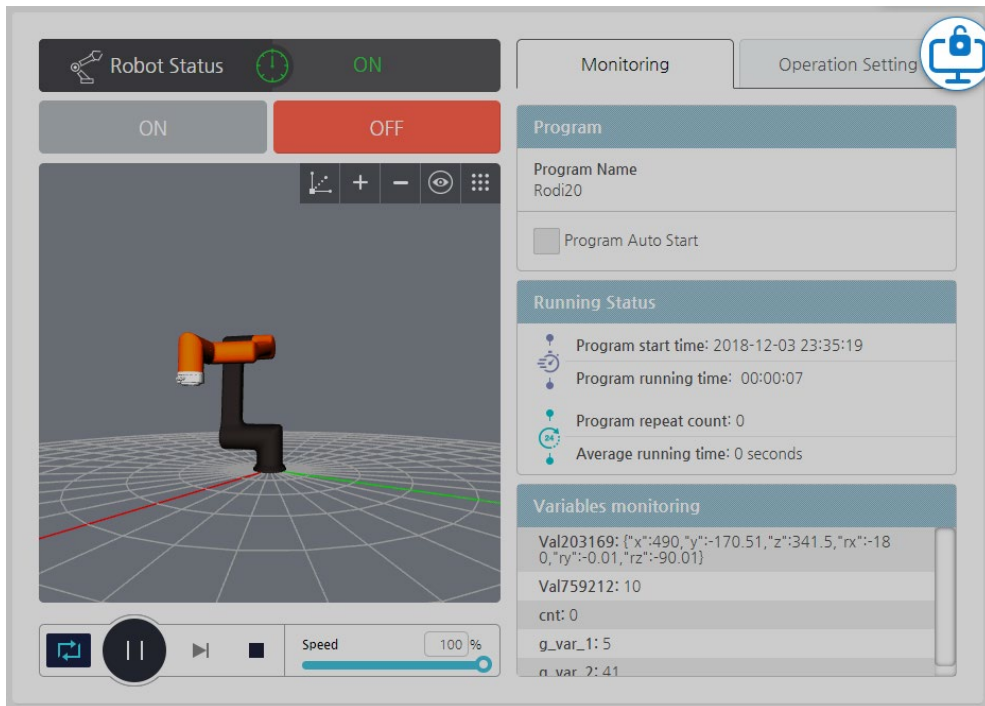

Chapter 11 Monitoring

You can check the selected robot's position/status and I/O status in real time.

11.1 Monitoring the Robot

You can check the robot's position and status in real time.

Select  **Monitoring** > **Robot Status** in the main menu.

Monitoring the robot positions

In the robot position tab, you can check the position of the selected robot (joint angle and speed) and see how it is moving in real time in 3D preview.

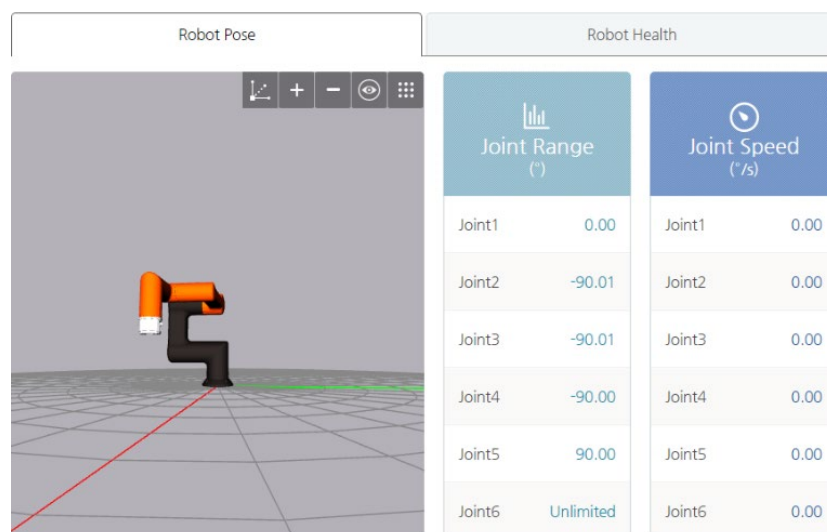

Checking the robot status

In the robot status tab, you can check the selected robot's power consumption, voltage or current.

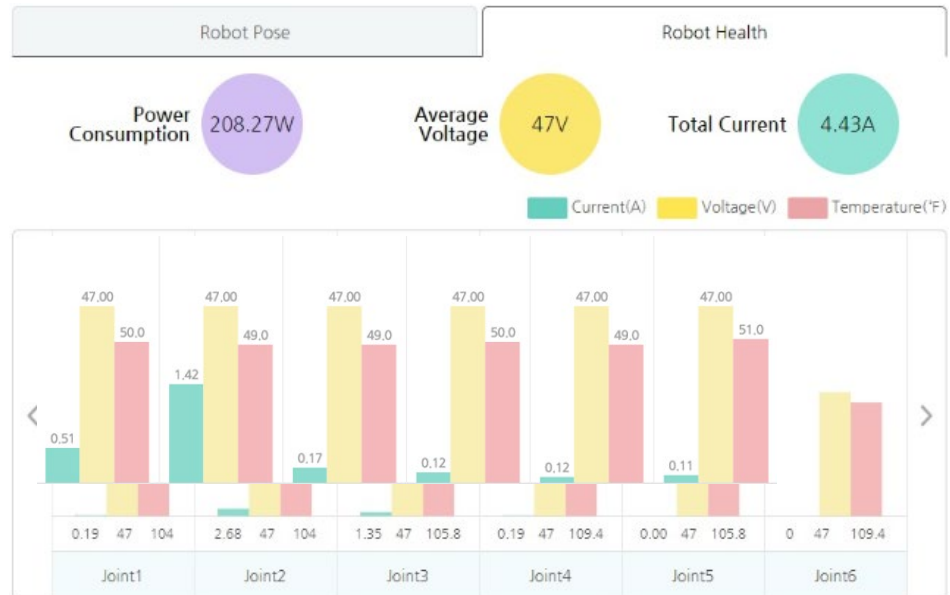



Note The monitoring values are displayed when the robot is running normally.

11.2 Monitoring Inputs/Outputs

You can check and set the real time I/O status of robot.

In the main menu, select **Monitoring > I/O Status**.

Note The monitoring period is 10 Hz.

- You can check the status of digital I/O by examining the following icons.
 -  Digital signal high
 -  Digital signal low
 -  No signal
- The input terminals that users cannot adjust the values for and the output terminals that users can adjust the values for are marked as follows.



Monitoring controller inputs/outputs

In the **I/O Status** tab, the status of signals transmitted to and received from the I/O terminal of the controller are displayed in real time.

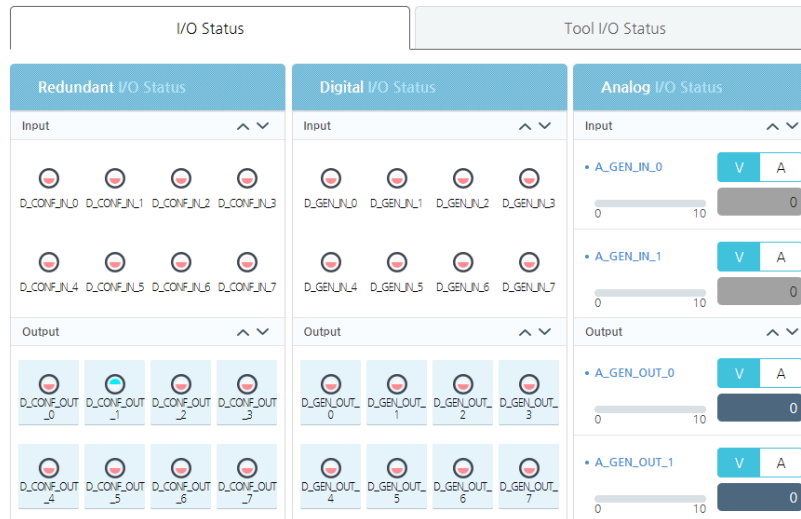

- You can press the I/O status icons to switch digital outputs to high and low. For example, if you press (High) then it switches to (Low).
- For analog outputs, you can press the icon to enter values.
 - Voltage range: 0 ~ 10.00 V
 - Current range: 0.004 ~ 0.02 A
- You can select either voltage or current as the analog I/O unit.
 - : Voltage(V) is used.
 - : Current(A) is used.
- If you change the unit of analog output, the output is changed to a minimum.

Note

- The number of terminals may vary depending on the controller specifications.
- If not all the terminals are displayed on the screen, press the up/down scroll button to scroll them.

Monitoring tool inputs/outputs

In the **Tool I/O Status** tab, the status of signals transmitted to and received from the I/O terminal of the tool flange are displayed in real time.

The screenshot displays the 'Tool I/O Status' monitoring interface. It is organized into four main sections:

- Digital Input:** Contains four status indicators labeled D_TOOL_IN_0, D_TOOL_IN_1, D_TOOL_IN_2, and D_TOOL_IN_3, each with a red circle icon.
- Analog Input:** Contains two channels, A_TOOL_IN_0 and A_TOOL_IN_1. Each channel has a 'V' (Voltage) and 'A' (Current) readout, a slider bar, and a '0' value display.
- Digital Output:** Contains four status indicators labeled D_TOOL_OUT_0, D_TOOL_OUT_1, D_TOOL_OUT_2, and D_TOOL_OUT_3, each with a red circle icon.
- Tool Power:** Contains a 'Voltage' section with radio buttons for 0 V, 12 V, and 24 V. Below it is a 'Current' section with a slider bar and a '0 A' value display.

- A tool's digital inputs/outputs and analog inputs are set and displayed in the same way those of the controller are set and displayed.
- If you can set the output voltage to a tool, then you can select one from 0 V, 12 V, or 24 V.

- Note**
- The value of the tool's current cannot be configured by the user.
 - If the robot status is servo-off or the emergency stop button is pressed to stop the robot, the monitoring screen may display abnormal information.

11.3 Utilization

You can check the robot's system operation time, servo start, and the program operation time information.



- **Cumulative system operation time:** Total cumulative system operation time from production time to present

Note The basic unit for collecting the operation time is every hour; as such, there may be error of up to one hour.

Chapter 12 Device Setting

You can link your robot to an external equipment such as a PLC, a vision equipment (object detection camera), and conveyor system.

Note Different external equipment is supported depending on the software version.

12.1 Configuring MODBUS TCP

TCP based MODBUS is supported as an extended interface to communicate with external devices such as PLCs. It is implemented in software and enables to set lots of IOs.

From the main menu, select **Robot Setting** > **MODBUS TCP**.

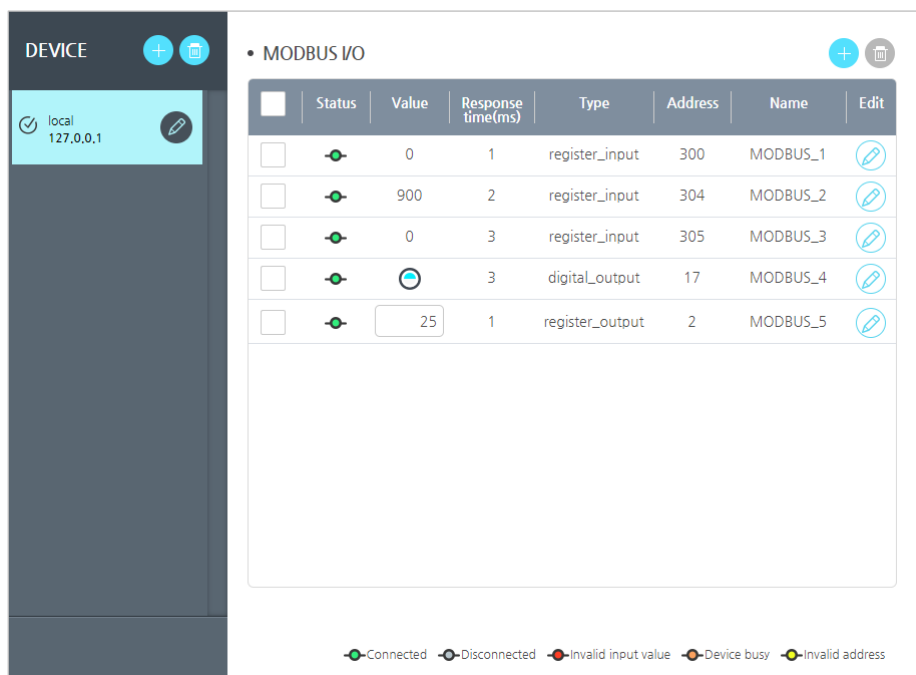

Registering Devices

To use MODBUS I/O, register a device to share I/O information with.

1. Press the Add button.

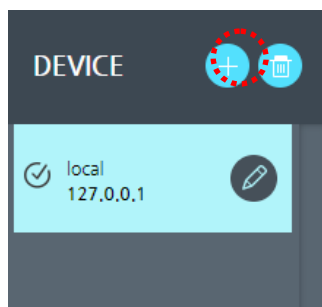

2. Enter following information in the **Add Device** screen and press the **Add** button.
 - **Device Name:** Enter the device name to be displayed on the screen.
 - **IP Address:** Enter the IP address of the device.
 - **Slave ID:** Enter the slave ID of the device. Its input range is 0 to 255 in the 3-digit integer form.

- **Description:** You may enter the description for the device. You can enter up to 25 characters.

The screenshot shows a dialog box titled "Add Device" with a close button (X) in the top right corner. The dialog contains the following fields:

- Device Name:** A text input field.
- IP Address:** A text input field with a dot separator.
- Slave ID:** A text input field with the value "255" entered.
- Description:** A text input field.

At the bottom of the dialog, there are two buttons: a blue "Cancel" button and a grey "Add" button.

Editing/copying the device settings

You can modify settings for a device previously registered or copy the device settings to use as settings for a new device. When copying, I/O information of the device is also copied.

1. Press the Edit  button from the list of registered devices.



2. Modify items you want to change and press the **OK** button. Or, press the **Copy** button if you want to copy the device settings to use as settings for a new device.
 - When you press the **Copy** button, the settings of the device currently selected and information of I/Os under the device are also copied and added to the list. The name of the newly created device is the name of the device copied from with '_number' added.

The 'Edit Device' dialog box has a dark header with a close button. Below the header are three rows of input fields: 'Device Name' with the value 'local', 'IP Address' with the value '127.0.0.1' and 'Slave ID' with the value '255', and an empty 'Description' field. At the bottom of the dialog are three buttons: 'Cancel', 'OK', and 'Copy'.

Deleting a device in the list

1. Select a device to delete from the list.
 - Check the check box for the device.

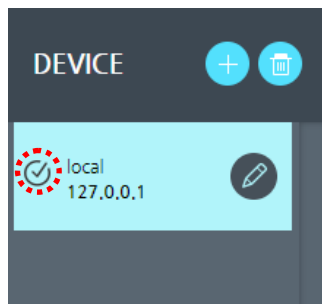

2. Press the Delete button, and then press the **OK** button.
 - When you delete a device, I/Os for the device will be deleted as well.



Registering I/O

After you registered a device, you must set an I/O or I/Os for it. The I/O(s) added is(are) used to read a certain value from the device or to send HCR status values to it.

The type of I/Os for the MODBUS are as follows:

- **Digital Input:** Reads digital values (High/Low) from a device.
- **Digital Output:** Sends digital values (High/Low) to a device.
- **Register Input:** Reads 2-byte values (0–65535) from a device.
- **Register Output:** Sends 2-byte values (0–65535) to a device.

1. Select a device to add an I/O to from the device list.
 - When a device is selected, I/Os currently added to it are displayed.
2. Press the Add  button.

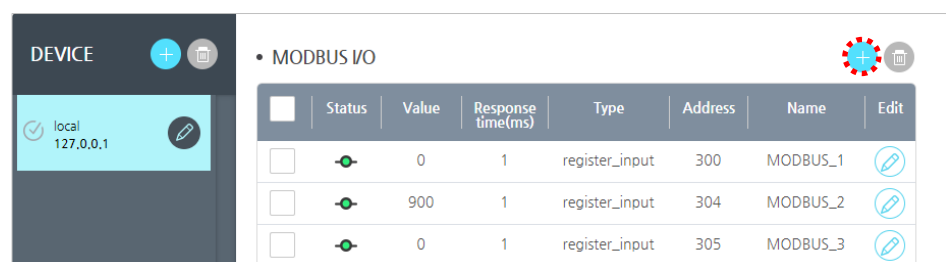

3. Enter information of the I/O and press the **OK** button.
 - **Name:** Enter the user identifiable name of the I/O.
 - **Signal Address:** Enter the pre-defined address to be used for the I/O.
 - **Type:** Select Digital I/O or Register I/O.
 - **Frequency:** Select the frequency of data transmission for the I/O. Available frequency values are 0, 1, 2, 5 and 10.

MODBUS Setting

Name: MODBUS_2 Signal Address: 0

Type: Register Input

• Advanced Option

Frequency[Hz]: 10

Cancel OK

Note You can use I/Os when you make a program. Especially, you can use register-type I/Os as variables in a program.

Viewing the communication status

After an I/O is registered, you can view its communication status.

<input type="checkbox"/>	Status	Value	Response time(ms)	Type	Address	Name	Edit
<input checked="" type="checkbox"/>		27	0	Register Input	300	MODBUS_1	
<input checked="" type="checkbox"/>		1567	0	Register Input	304	MODBUS_5	
<input type="checkbox"/>		27	0	Register Input	305	MODBUS_6	
<input type="checkbox"/>			0	Digital Output	0	MODBUS_7	
<input type="checkbox"/>		<input type="text" value="0"/>	1	Register Output	0	MODBUS_8	



	Normal
	Unable to connect
	Input value error
	Device response delay
	Address error

Viewing and setting the I/O values

After an I/O is registered, you can view or set its value.

<input type="checkbox"/>	Status	Value	Response time(ms)	Type	Address	Name	Edit
<input checked="" type="checkbox"/>		27	0	Register Input	300	MODBUS_1	
<input checked="" type="checkbox"/>		1567	0	Register Input	304	MODBUS_5	
<input type="checkbox"/>		27	0	Register Input	305	MODBUS_6	
<input type="checkbox"/>			0	Digital Output	0	MODBUS_7	
<input type="checkbox"/>		<input type="text" value="0"/>	1	Register Output	0	MODBUS_8	

- Digital Input: Indicates an icon for the digital value (High/Low) currently being input.
 - : High
 - : Low
- Digital Output: Indicates an icon for the digital value (High/Low) currently being output. Press the value to change it.

- : High
- : Low
- Register Input: Indicates the value currently read from the device.
- Register Output: Indicates the value being currently sent to the device. Press the value to change it.



Editing I/O settings











1. Press the Edit  button of an I/O to be modified from the I/O list.
2. Modify the settings and press the **OK** button.

Note It is not allowed to change the I/O type. To change the type, you must delete the I/O setting and add it again.



Deleting I/O











1. Select an I/O to delete from the I/O list.

• MODBUS I/O  

<input type="checkbox"/>	Status	Value	Response time(ms)	Type	Address	Name	Edit
<input checked="" type="checkbox"/>		27	0	Register Input	300	MODBUS_1	
<input checked="" type="checkbox"/>		1567	0	Register Input	304	MODBUS_5	
<input type="checkbox"/>		27	0	Register Input	305	MODBUS_6	
<input type="checkbox"/>			0	Digital Output	0	MODBUS_7	
<input type="checkbox"/>		<input type="text" value="0"/>	1	Register Output	0	MODBUS_8	

2. Press the Delete  icon.

• MODBUS I/O  

<input type="checkbox"/>	Status	Value	Response time(ms)	Type	Address	Name	Edit
<input checked="" type="checkbox"/>		27	0	Register Input	300	MODBUS_1	
<input checked="" type="checkbox"/>		1567	0	Register Input	304	MODBUS_5	
<input type="checkbox"/>		27	0	Register Input	305	MODBUS_6	
<input type="checkbox"/>			0	Digital Output	0	MODBUS_7	
<input type="checkbox"/>		<input type="text" value="0"/>	1	Register Output	0	MODBUS_8	

12.2 Using a Vision System

You can register the vision to be linked to the robot and configure necessary settings.

In the main menu, press  **Device Setting** > **Vision System**.

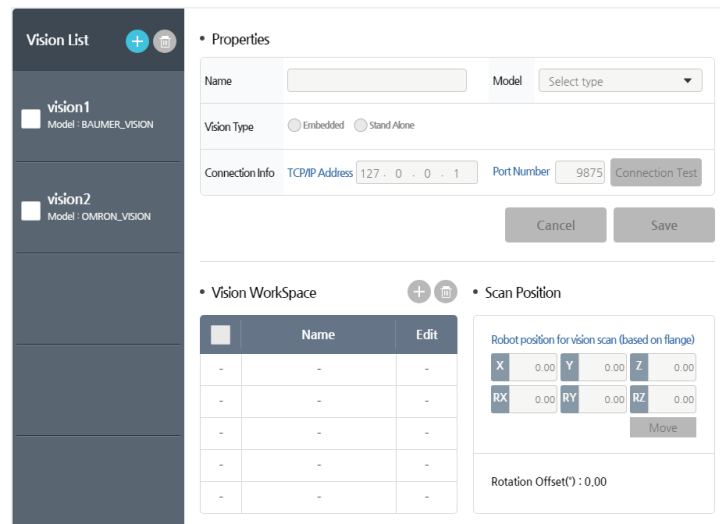

To interwork with the vision, the following two steps are required.

- **Vision System Setting**

- Communication Setting: To send and receive data to and from the vision system, data is exchanged via TCP/IP communication. The vision system should be set up to use TCP/IP communication.
- Exchange Data Format (Protocol) Setting: To exchange data with the robot system, the type and format of the data sent from the vision system should be set as follows.

- **Data Communication Protocol**

The data format consists of a string, which is set up to be transmitted by the vision system in the following conventions.

TJG	,	X	,	Y	,	TH	CR	LF
-----	---	---	---	---	---	----	----	----

TJG: Result value from object recognition in the vision. 1(Success) or 0(Fail)

X: X coordinate value of object recognized by the vision

Y: Y coordinate value of object recognized by the vision

TH: Rotation theta value of object recognized by the vision

CR, LF: Separator for the end of data

Comma(,): Separator for each item

- **Robot System Setting**

- **Interworking vision setting:** Sets the model and communication connection information of the vision to be interworked.
- **Vision workspace setting:** One vision camera can have a number of vision work areas, and by using the information set by the 'Vision workspace setting,' the vision coordinates recognized by the vision are converted into the robot coordinates to move the robot.

12.3 Adding and setting vision equipment

Adding a vision equipment

Press the **Add** button. They will be added under names such as Vision1, Vision2 to the list and they become configurable.

Setting a vision equipment

- **Name:** Enter the equipment name. (The length of name is limited to 15 letters and special characters cannot be used.)
- **Model:** Select the manufacturer for your vision equipment.
 - Omron vision
 - Cognex vision
 - Hostar vision
 - Keyence vision
 - Baumer vision

Note Different vision equipment is supported depending on the software version.

- **Connection info:** Enter the TCP/IP address and the port number necessary for communication between a vision equipment and the robot.
 - Range of port number: 0 ~ 65535
 - Press the **Connection Test** button to check the status of connection with a vision equipment by using the connection data.

Note To perform the connection test correctly, the vision system and our system must be connected to a single network before the test.

- **Vision Type:** Select a type of vision installation.
 - **Embedded:** Attached to the robot arm.
 - **Stand Alone:** Fixed to another location and detached from the robot arm.

12.4 Setting Vision Workspace

Vision workspace setting sets information to change the vision coordinate recognized by the vision to the robot coordinates. Up to 5 workspaces can be set for one vision.

Adding Vision Workspace

- **To add a vision workspace, select the vision already added from the vision list.**
- When you click the **Add vision workspace**  button, the following workspace setting screen appears.

The screenshot shows the 'Robot Vision Coordinates Calibration' interface. It includes a central checkerboard with points P1, P2, and P3. A 'Vision test' panel on the left allows for testing robot and vision coordinates. The right side contains three point configuration sections (Point1, Point2, Point3), each with 'Set Point' and 'Move' buttons and a table of coordinates (X, Y, Z, RX, RY, RZ). Below the checkerboard is a 'Rotation Direction Setting' section with 'Clockwise' and 'Counterclockwise' options. At the bottom are 'Cancel', 'Reset', and 'Apply' buttons.

- **Name** : Enter a name for the vision workspace. The input range is up to 15 characters, and no special characters are allowed. (Exclude '-' and '_'.)
- **Vision Scan Coordinates**: If the vision type is **Embedded**, the setting is necessary for moving the robot arm to the scanning location.
 - Press the **Move** button to move the robot arm to desired location and view it there.
 - Press the **Set Point** button to launch the manual control screen. For more details about the manual control screen, refer to [5.3 Manual Move Screen](#).
- **Rotation Offset**: If the vision type is **Stand Alone**, you can set the angle between the robot's location and the scanning location, so that the rotational angle for an object necessary for a gripper to hold it. Press the **Set Offset** button to automatically set the rotation offset. For more details, refer to the next page.

- **Vision Test:** Test vision with the set values.
- **Set Points:** It matches the number of guide image and is activated by clicking the number. The initial value is '0'. At each number, enter the robot coordinate values and the coordinates of the vision system at that point. Range :
-10000~10000(Pixel)
- **Rotation Direction Setting:** Sets the rotation direction of the object recognized by the vision.

Note	When attaching the vision to the robot arm, attach the upper left / upper right / lower right directions shown on the setup screen so that they match the directions shown in the vision software.
------	--

Understanding rotation offsets

When a vision equipment scans an object, the angle of shifted position for an object is used the reference for a vision equipment. Thus, the angle data of object that a vision equipment sends to the robot is obtained from the perspectives of vision equipment. Now, if the robot does not know the angle between the scanning location and the its position (rotation offset), then the robot will assess the scanned angle data from its own perspectives and use a gripper accordingly, thus making it hard to pick up an object accurately.

As shown below, if the scanning location is same as the basic TCP location of robot (A) all it has to do is to rotate the gripper angle by as much as the angle of scanned object. However, if the scanning location is shifted by X degrees from the robot base, then when an object is scanned, although a vision equipment detects the angle of object as same as from the location (A), its gripper will have to rotate by X degrees to pick it up. In other words, from the robot's perspectives, it is same as if an object is shifted by X degrees, so, a rotation offset is required to compensate for the angle of object sent from a vision equipment.

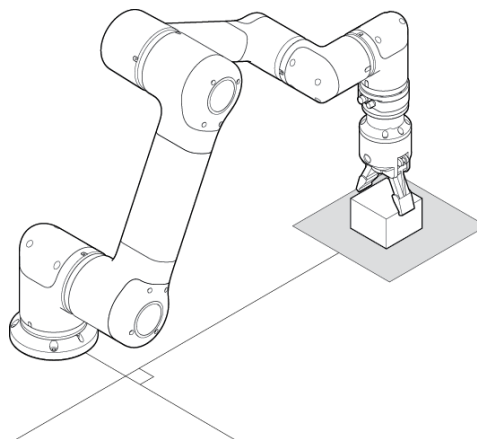

A. When the scanning location and the robot's location are on the same line

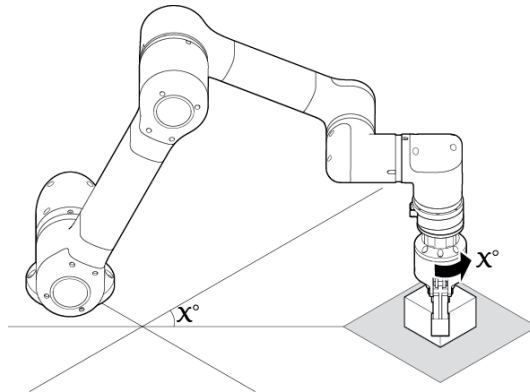

B. When the scanning location and the robot's location are shifted by X°

Chapter 13 Environment Setting

13.1 General Setting

You can select the desired UI language and unit also set the time/date.

In the main menu, press  **SW Configuration** > **General**.

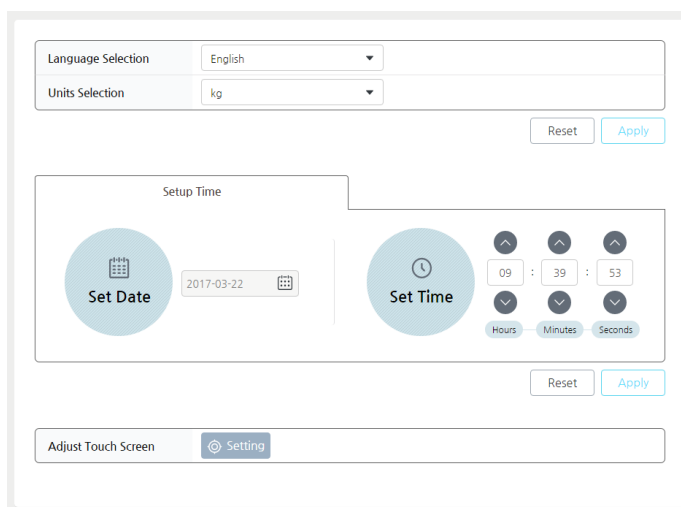

- **Language Selection:** You can select a language for the UI.
- **Units Selection:** You can select units of weight.
- **Set Date / Set Time:** You can set the system date/time.
- **Adjust Touch Screen:** If it is hard to touch a desired location on the screen, then you can correct the touch locations.

Note The language and unit settings are immediately applied to the system without restarting it, but the time/date are applied to the system after restarting it.

13.2 Network setting

You can configure the network settings for Ethernet communication of your operation software.

In the main menu, press  **SW Configuration > Network.**

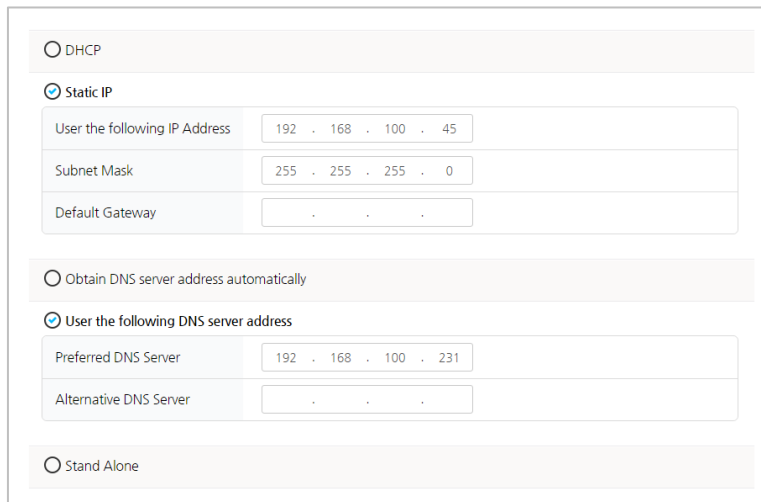

The screenshot shows a network configuration interface with the following settings:

- DHCP
- Static IP**
 - User the following IP Address: 192 . 168 . 100 . 45
 - Subnet Mask: 255 . 255 . 255 . 0
 - Default Gateway: . . .
- Obtain DNS server address automatically
- Use the following DNS server address**
 - Preferred DNS Server: 192 . 168 . 100 . 231
 - Alternative DNS Server: . . .
- Stand Alone

- **DHCP:** IP address is automatically assigned.
- **Static IP:** Fixed IP address is used.
- **Obtain DNS server address automatically:** DNS address is automatically received.
- **Use following DNS server address:** Use the DNS server designated by the user.
- **Do not use:** Do not connect to the network. Use it as standalone.

Note For more details about network settings, consult with your system network administrator.

Chapter 14 Turning Off the System

14.1 Shutting Down the Operation Software

To shut down the operation software, proceed as follows.

1. Select  **SW Configuration** > **Shutdown** in the main menu.
2. Press the **OK** button.

- | | |
|-------------|---|
| Note | <ul style="list-style-type: none">• You can press the power button of the teaching pendant to shut it down.• If the operation software does not shut down properly, press and hold the power button of the teaching pendant for 5 to 10 seconds. |
|-------------|---|

Caution

Shutting down the system improperly may cause problems for the software. If the software has a problem after abnormal system termination due to the reason that the system is forcefully turned off by the power switch or the Power button of TP, or the power is out, contact local distributor.

14.2 Turning Off Controllers

After shutting down the operation software, press the power switch to turn off the controller.

Chapter 15 Maintenance

15.1 Inspection Items and Periods

Periodic inspections are required to maintain the robot in the best condition for a long period of time. An inspector should prepare and execute an inspection plan.

The following items require periodic inspections. If you found some problems during inspections, and you can resolve them on your own, contact Hanwha Precision Machinery Co.

Inspection item	What to inspect	Periods	
Robot arm	All	Check if the robot moves to the desired destination according to the program.	Daily
	All	Remove stains, dusts and pollutants.	3 months
	All	Check if the robot arm or tool sags when you turn on/off the servo power.	Daily
	Main bolts	Check if the bolts exposed to the outside of the robot is loose.	3 months
	Motor	Check for abnormal heat generation or noises.	Daily
Controller	Cable	Check the cable connections.	
	Internal	Remove dusts from the inside.	6 months
	Filter	Remove dusts from the filter.	

15.2 Checking the Robot Arm

Inspection period

Inspect at least once every 6 months. The inspection period may vary depending on the inspection area.

Checking and cleaning the robot arm

1. Move the robot arm to home.
2. Turn on the controller.
3. Check the followings.
 - Check the cable connecting the controller and the robot arm.
 - Check if the screws exposed outside is loose or unfastened.
 - Check for defects in the motor, the brake and the decelerator.
4. Remove stains, dusts and pollutants.

15.3 Checking the Controller

If dusts accumulate inside the controller, electrostatics or overheating can cause product malfunctions. Periodically check the inside of the controller and clean off dusts and check if the internal cables are connected properly.

Inspection period

Inspect at least once every six months.

Note	The inspection periods may vary depending on the installation environment.
-------------	--

Checking and cleaning the controller

1. Turn off the power for the controller.
2. Open the cover for the controller.
3. Check if there are dusts inside the controller.

4. If there are dusts, then use a vacuum cleaner to carefully remove dusts.
5. Check if the connector cables are connected properly.

Cleaning and replacing the filter

The controller has an air suction hole and an air discharge hole, which have dust filter mounted in them.

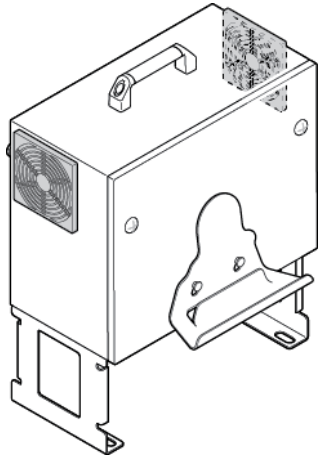

Separate the filter from the controller and use a vacuum cleaner or air compressor to remove dusts.

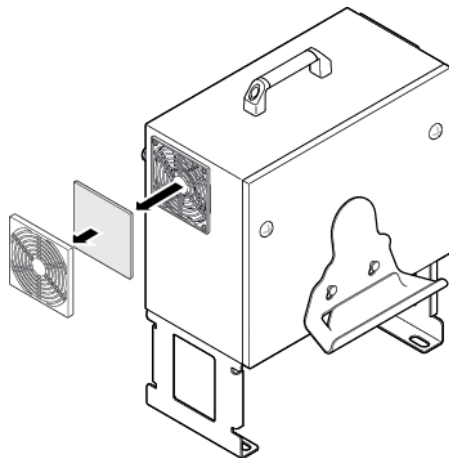

15.4 Viewing and Managing Logs

You can view and manage the logs for the operation system.

Select **Management > Log** in the main menu.

Type	Controller	Robot Name	Date/Time	Log Description
[event]	controller	[HCR5]	2018-12-03 23:37:20:301	programEvent : program_stop
[event]	controller	[HCR5]	2018-12-03 23:35:20:475	programEvent : program_toolChange
[event]	controller	[HCR5]	2018-12-03 23:35:20:189	programEvent : program_toolChange
[event]	controller	[HCR5]	2018-12-03 23:35:19:836	programEvent : program_start
[event]	controller	[HCR5]	2018-12-03 23:35:14:482	programEvent : program_end
[event]	controller	[HCR5]	2018-12-03 23:35:04:608	programEvent : program_toolChange
[event]	controller	[HCR5]	2018-12-03 23:35:04:330	programEvent : program_toolChange
[event]	controller	[HCR5]	2018-12-03 23:35:03:916	programEvent : program_start
[event]	controller	[HCR5]	2018-12-03 23:26:53:607	programEvent : program_end
[event]	controller	[HCR5]	2018-12-03 23:26:44:139	programEvent : program_toolChange

Total Count: 29 Case

Information Warning Error

Deleting Logs

Press the **Delete** button and the log data found will be deleted.

Exporting Logs

1. Press the **Export** button.
2. Select the location to export the logs into and press the **OK** button.

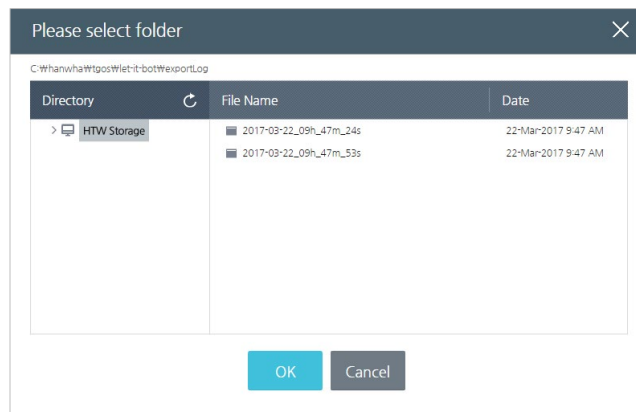

When export is finished, a folder in the form of 'date-time' is created at the selected location, and the log data are saved in the folder along with the robot configuration and program files.

15.5 Managing the Robot System Configuration

You can save the robot configuration in a local or external storage device or retrieve the saved robot configuration from them.

In the main menu, select **Management** > **Setting Management**.

Robot Name: HCR5 Packing Pose Factory Reset

Use Default Program
 Rodi20.file ▼ Auto Start Program on System Startup
 D_GEN_IN_0 (Unassigned) ▼ = High ▼

Initial Setup File
 Please select a setting file. ▼ Auto Servo On
 D_GEN_IN_1 (Unassigned) ▼ = High ▼ Apply

File Directory ↻
 HCR Storage ✓

	File Name	Date / Time
<input type="checkbox"/>	cfg.robotConfig	November 30, 2018

C:\Program Files\HCR Rodi Sim\data\configs

File Name Export Delete Import

Packaging posture

- Arrange the posture of the robot in a position that allows it to be placed in the delivery box.
- The robot only operates while the button is pressed.
- The posture depends on the model of the target robot.

[J1:0, J2:-90, J3:-160, J4:-90, J5:180, J6:0]

Factory reset

- Initializes the system to its factory settings.
- A warning message is displayed twice before the reset is performed.
When the factory reset is complete, the system restarts.

Note If you perform a factory reset, all information including the robot information will be deleted. Please back up the necessary information before you perform a reset.

Use Default Program

Set the program and configuration file to load automatically when the robot is booted. It provides Servo On and program start function automatically after booting.

- Check **Use Default Program** to activate it.
- Select the program to be loaded among the stored programs.
- Set the condition of **Auto Start Program on System Startup**.
- Select **Initial Setup File** to use among the saved configuration files.
- Set the condition of **Auto Servo**.

Note The available inputs are Digital Input or Digital Input of Modbus TCP.

Exporting the configurations

You can save the following settings by exporting them.

Robot Setting	TCP Setup
	Mounting
Safety Setting	Motion Limit
	Safety Boundary
I/O Setup	Digital I/O
	Analog I/O

1. Select the file path to export.
 - Press the refresh  button to update the storage list and the file list.
2. Press the filename input field and enter the filename.
 - Filename is limited to 25 letters, and empty character is not allowed.
3. Press the **Export** button.
4. When the confirmation window appears, press **YES**.

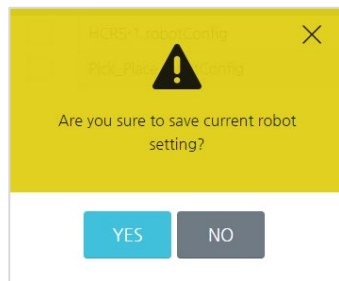

Importing the configurations

1. Select the file path for importing.
 - Press the refresh  button to update the storage list and the file list.
2. Press the **Import** button.
3. Select the configuration items to import and press the **OK** button.
 - You can select multiple items.
 - If you want to deselect it, press it again.

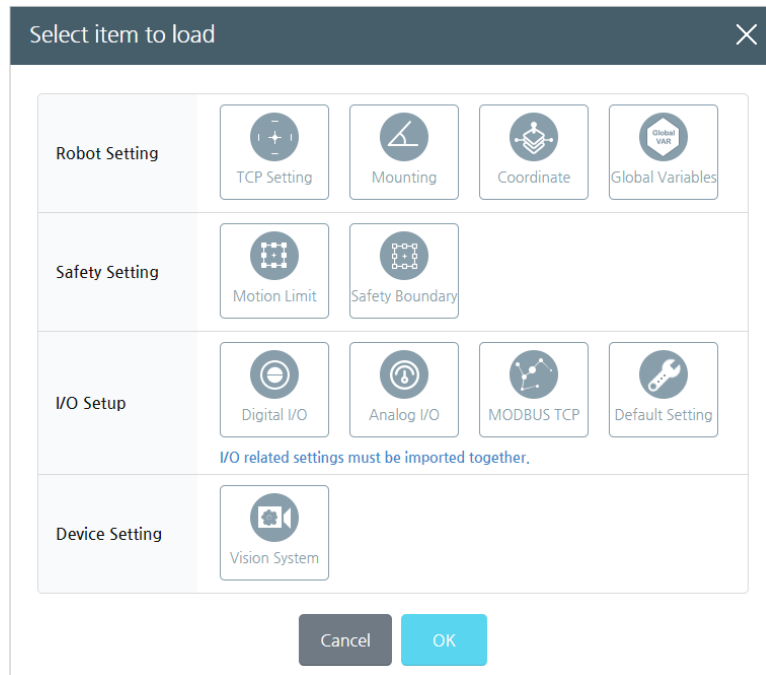

4. When the confirmation window appears, press **YES**.

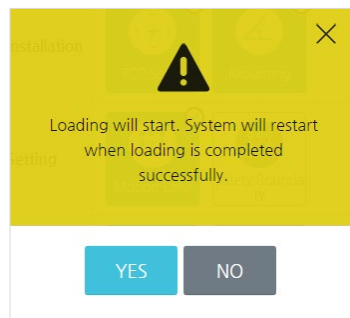

15.6 Software Update

You can update the software.

In the main menu, press  **SW Configuration** > **SW Update**.

• Current Version					
Rodi Software		Ver. 2.001.003.013			
Controller Software		Ver. N/A			
Update		<input type="text"/>	<input type="button" value="Import"/>	<input type="button" value="Update"/>	
• Safety Module Version					
Current Version		Ver. N/A			
• Tool I/O Version Info					
Current Version		Ver. N/A			
• Servo Driver Version					
Joint1	N/A	Joint2	N/A	Joint3	N/A
Joint4	N/A	Joint5	N/A	Joint6	N/A

Cautions during update

- Update can be performed using the external storage device only.
- **If you connect a USB drive to TP, as there is a lot of data, the operating software may not be updated normally. Be sure to connect directly to the controller.**
- Update files may be composed of multiple files instead of a single file. For proper update of files, do not modify the name or path of an update file package arbitrarily.
- The update function is not available for general users but for the user with a certain authority. If you need an update, contact Hanwha Precision Machinery or a local service center.

Updating software

Check the version of the software and proceed as follows:

1. Connect the external storage device (such as the USB memory) where the update files are stored to the USB port of the teaching pendant or the controller.

2. In the software update screen, press the **Import** button.



3. Select an update file in the correct location and press the **OK** button.

- The extension of the update file is "tgos", and the update file name contains its version. The file selection window displays applicable files only.

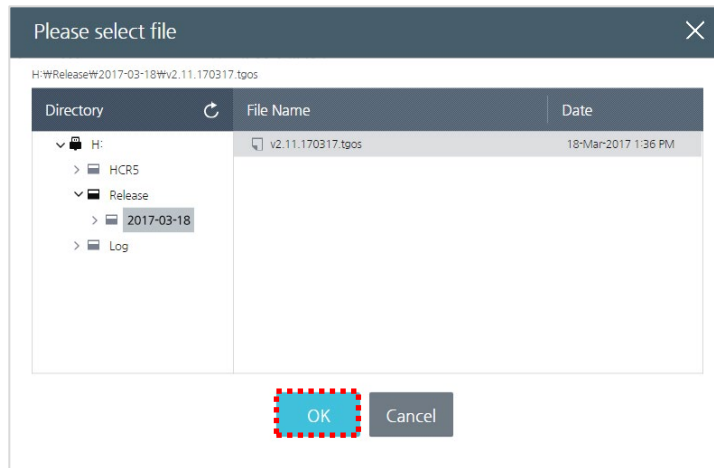

4. From the software update window, press the **Update** button.



When the operation software is updated the system restarts.

Appendix A Warranty

Refer to the contract between the sales team and you.

Warranty

Our company guarantees specifications, quality and reliability that our customer demands during the warranty period.

Warranty period

One year since the date of equipment purchase (varies depending on the contract between our company and you.)

Limitation of Liability

- If a problem occurs after the customer mounts an unauthentic part in our product, our company will not be responsible for it.
- If your product has a fault deemed as our company's responsibility, we will immediately repair it or replace the product with a good one.

Appendix B Certification

Safety



Safenet Limited

Denford Garage, Denford, Kettering, Northants., NN14 4EQ, U.K.

Tel: +44 1832 732174 E-mail: office@safenet.co.uk

European Notified Body 1674

EN ISO 13849-1:2015 Compliance Certificate

This is to certify that

Hanwha Techwin Co., Ltd.

1204, Changwon-daero, Seongsan-gu, Chang-won-si,
Gyeongsangnam-do, Korea

Has had a Safety Module for HCR examined to the International and European Standard BS EN ISO 13849-1:2015.

The following safety functions have been identified and their achieved performance level is listed below:

Safety Function	PL
1) Stop Monitoring	d
2) Joint Position Monitoring	d
3) Joint Velocity Monitoring	d
4) Joint Position Limit Monitoring	d
5) Joint Velocity Limit Monitoring	d
6) Joint Torque Limit Monitoring	d
7) TCP Position Monitoring	d
8) Collision Detection	d
9) Brake Monitoring	d
10) Emergency Switch Monitoring	d
11) H/W Monitoring	d

The technical documentation supplied contains all the information to include the following models in the certification; HSM-V1. All the safety functions above have been realised using an architecture that exhibits Category 3 behaviour, as defined in BS EN ISO 13849-1:2015.

Certificate Number: 6760020517 version 2

Date: 19/05/2017

Signed for Safenet Limited

Peter McNicol
Technical Manager

This Document remains the property of Safenet Ltd and will be returned to them if so requested. Safenet will review the continued compliance of the machinery on a 5 yearly cycle to check for changes in the state of the art.



MD(Machinery Directive)



CERTIFICATE OF COMPLIANCE

Certificate No. MDC 2246

SGS Reference:	CST266302/1		
Date of Issue:	2 nd April 2019	Issue No.: 1	Expiry Date: 12 th November 2023
Client/Applicant:	Hanwha Precision Machinery Co., Ltd. 84, Jeongdong-ro, Seongsan-gu, Chang-won-si, Gyeongsangnam-do, Republic of Korea		
Manufacturer:	Same as above		
Scope of certification:	Full technical file assessment according to Annex VII 2006/42/EC and EN ISO 12100:2010, EN ISO 13849-1:2015, EN 60204-1:2006/AC:2010, EN ISO 10218-1:2011		
Description of Equipment	Collaborative robot		
Type/Series:	HCR-3 with HC-S(Controller)		
Serial Number(s):	-		
Trade Mark/Name:	 Hanwha		
Assessment Performed:	Assessed for compliance with the requirements of Annex VII of the Machinery Directive 2006/42/EC and EN ISO 12100:2010, EN ISO 13849-1:2015, EN 60204-1:2006/AC:2010, EN ISO 10218-1:2011		
Conclusion:	In the opinion of SGS United Kingdom Limited the submitted technical file referenced as CST266302/1 satisfies the requirements of the Machinery Directive 2006/42/EC		
Authorised Signature			
Daniele Paoli			
Machinery Manager			

Page 1 of 1

The CE mark as shown below can be used, under the responsibility of the manufacturer, after completion of an EC Declaration of Conformity and compliance with all relevant EC Directives.

CE

This document is issued by the Company subject to its General Conditions of Service printed overleaf, available on request or accessible at <http://www.sgs.com/en/Terms-and-Conditions.aspx> and, for electronic format documents, subject to Terms and Conditions for Electronic Documents at <http://www.sgs.com/en/Terms-and-Conditions/Terms-e-Document.aspx>.

Attention is drawn to the limitation of liability, indemnification and jurisdiction issues defined therein. Any holder of this document is advised that information contained hereon reflects the Company's findings at the time of its intervention only and within the limits of Client's instructions, if any. The Company's sole responsibility is to its Client and this document does not exonerate parties to a transaction from exercising all their rights and obligations under the transaction documents. This document cannot be reproduced except in full, without prior written approval of the Company. Any unauthorized alteration, forgery or falsification of the content or appearance of this document is unlawful and offenders may be prosecuted to the fullest extent of the law.*

SGS United Kingdom Limited
Unit 12A & 12b, Bowburn South Ind Est, Bowburn Durham, DH6 5AD Tel +44 (0)191 377 2000 Fax +44 (0)191 377 2020
Registered in England No. 1193985 Rossmore Business Park, Ellesmere Port, Cheshire CH65 3EN www.sgs.com
Member of SGS Group (SGS SA)

MD 38 Iss 03 - 02/09/2016

This document is issued, on the Client's behalf, by the Company under its General Conditions of Service printed overleaf. The Client's attention is drawn to the limitation of liability, indemnification and jurisdiction issues defined therein.

Any other holder of this document is advised that information contained hereon reflects the Company's findings at the time of its intervention only and within the limits of Clients instructions, if any. The Company's sole responsibility is to its Client and this document does not exonerate parties to a transaction from exercising all their rights and obligations under the transaction documents.

SGSPAPER
19356893



LVD(Low Voltage Directive)

Reference: 21187S

SGS

STATEMENT OF COMPLIANCE

Product: Collaboration robot

Applicant: Hanwha Precision Machinery Co., Ltd.
84, Jeongdong-ro, Seongsan-gu, Chang-won-si,
Gyeongsangnam-do, Republic of Korea

Manufactured at (name and place) Hanwha Precision Machinery Co., Ltd.
84, Jeongdong-ro, Seongsan-gu, Chang-won-si,
Gyeongsangnam-do, Republic of Korea

Trade mark (if any):  Hanwha

Model/Type Ref: HC-S

Ratings and principal characteristics: 100-240 V~, 50-60 Hz, 1 kW

Additional information (if any) :

The above-mentioned product(s) has (have) been found to be in compliance with:

EN 61010-1:2010, EN 61010-2-201:2013

as shown in the test report(s) F690501/RF-SAF010970

This Statement of Compliance is the result of the evaluation of the test reports and related product(s) information, in accordance with the provisions of the relevant specific standard(s). It does not imply an assessment of the whole production. Compliance of the produced products with the certified specimen remains on the full responsibility of the manufacturer.

Brussels, 22/03/2019

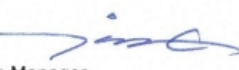
Yuta Kim,
Certification Manager.



SGS Belgium NV – Division SGS CEBEC
Riverside Business Park
Bld. Internationalaan, 55 Buid. D
BE-1070 Brussels
Tel. +32 2 556 00 20
Fax +32 2 556 00 36

EMC (Electro Magnetic Compatibility)

Reference: 211715

SGS

STATEMENT OF COMPLIANCE

Product: Collaboration robot

Applicant: Hanwha Precision Machinery Co., Ltd.
84, Jeongdong-ro, Seongsan-gu, Chang-won-si
Gyeongsangnam-do, 51552, Republic of Korea

Manufactured at (name and place): Hanwha Precision Machinery Co., Ltd.
84, Jeongdong-ro, Seongsan-gu, Chang-won-si
Gyeongsangnam-do, 51552, Republic of Korea

Trade mark (if any):  Hanwha

Model/Type Ref: HCR-3 with HC-S(Controller)

Ratings and principal characteristics: 100 - 240 V~, 50 / 60 Hz

Additional information (if any) :

The above-mentioned product(s) has (have) been found to be in compliance with:

EN 61000-3-2:2014, EN 61000-3-3:2013, EN 61000-6-2:2005, EN 61000-6-4:2007 + A1:2011

as shown in the test report(s) F690501/RF-EMC004404(H)

This Statement of Compliance is the result of the evaluation of the test reports and related product(s) information, in accordance with the provisions of the relevant specific standard(s). It does not imply an assessment of the whole production. Compliance of the produced products with the certified specimen remains on the full responsibility of the manufacturer.

Brussels, 11/03/2019

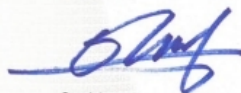

Carl Lee,
Certification Manager.



SGS Belgium NV – Division SGS CEBEC
Riverside Business Park
Bid. Internationelelaan, 55 Build. D
BE-1070 Brussels
Tel. +32 2 556 00 20
Fax +32 2 556 00 36

Appendix C Dimensions for Installation

TOP VIEW OF HCR3 BASE

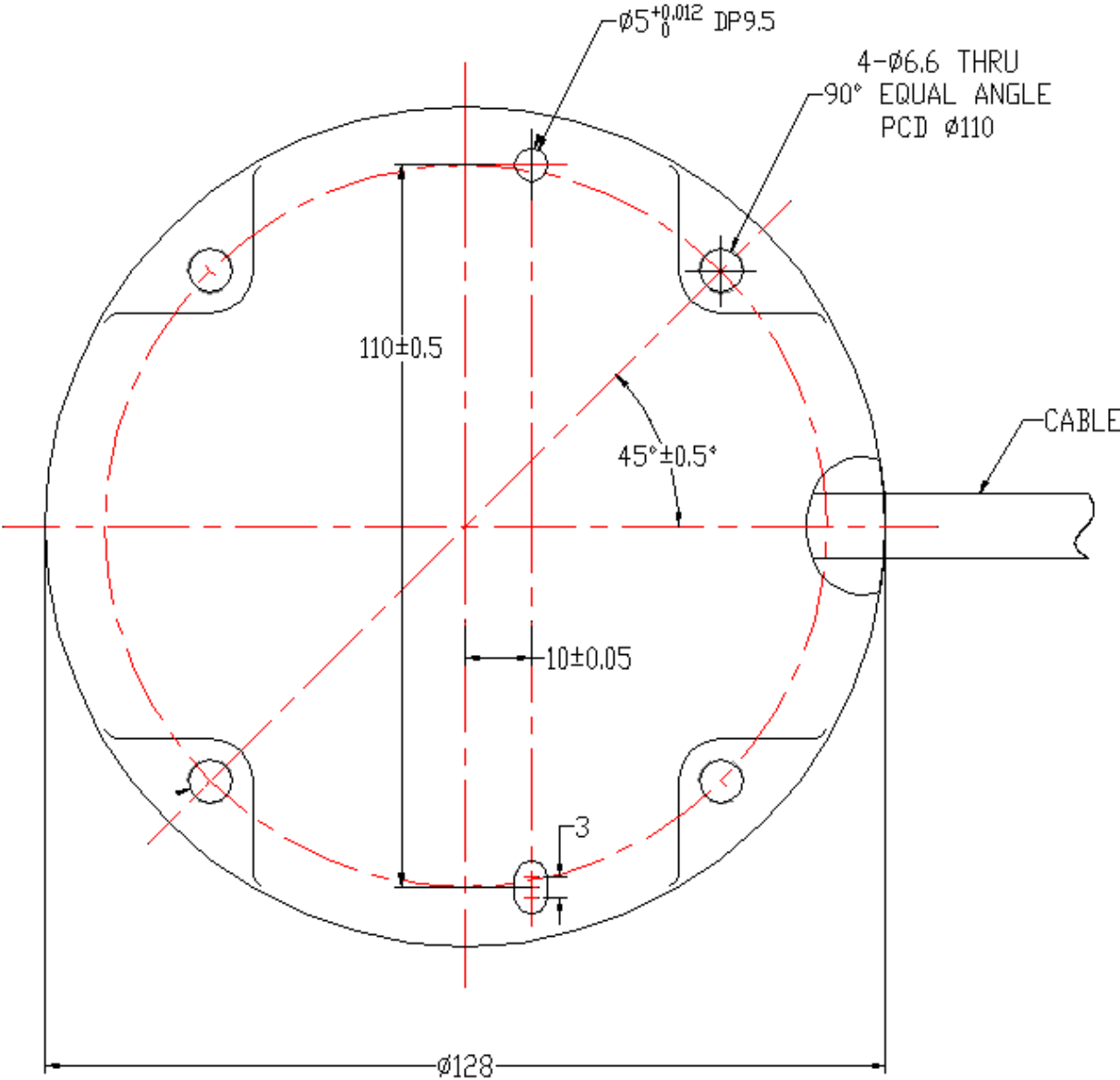

Appendix D Tool Flange Cross Section

The tool flange is designed suitable for ISO9409-1-50-4-M6.

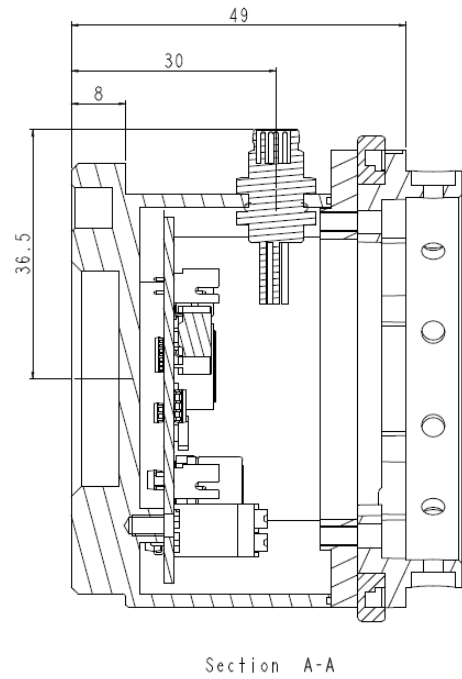
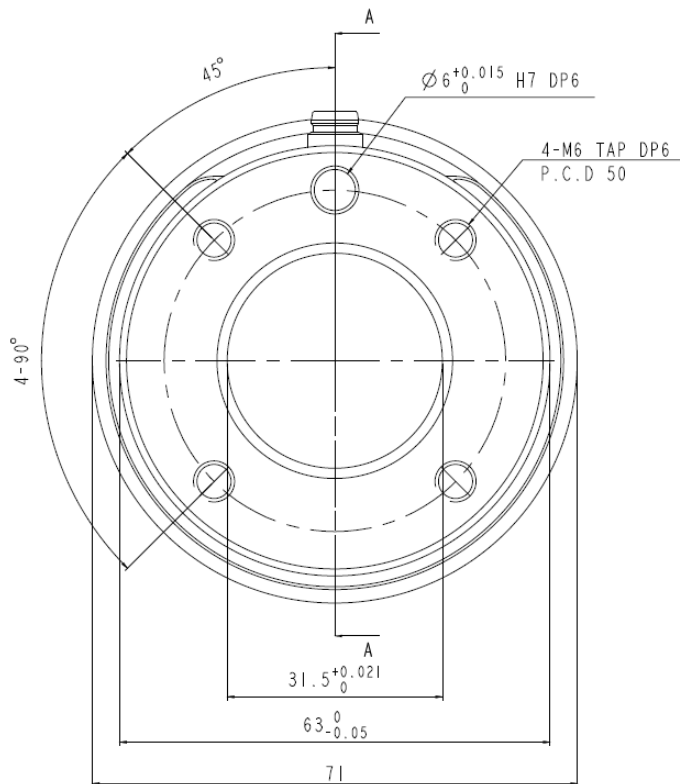

Appendix E Port Pin Map

Ports in the tool flange have the following specifications.

- Tool I/O: SACC-DSI-M8FS-8CON-M8/0,5 - 1458790

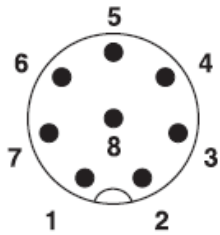
Port	Layout	Pin number	Signal	Color
Tool I/O		1	Analog Input Ch 1	White
		2	Analog Input Ch 0	Brown
		3	Digital Input Ch 0	Green
		4	Digital Input Ch 1	Yellow
		5	0/12/24 Vdc	Gray
		6	Digital Output Ch 0	Pink
		7	Digital Output Ch 1	Blue
		8	Ground	Red

Appendix F System Specifications

Degree of freedom	6		
Base weight	3 kg		
Working radius	630 mm		
Joint rage	$\pm 360^\circ$ (J3: $\pm 160^\circ$, J6: \pm Infinited)		
Repeatability	± 0.1 mm		
Weight	13 kg		
Bottom area size	$\varnothing 128$ mm		
Temperature	0 – 50°		
IP class	IP64 (Robot Arm) / IP20 (Robot Controller)		
Power supply	100 – 240 VAC, 50 – 60 Hz		
		Controller	Tool connector
I/O port	Digital input	16	2
	Digital output	16	2
	Analog input	2	2
	Analog output	2	–
I/O power supply	Controller: 24 V 2 A		
	Tool Connector: 12 V or 24 V 1.6 A		
External communication	TCP/IP, Modbus TCP, CC-link / Profinet / Ethernet / IP (Gateway needed)		
Cable length	Robot arm to controller connection cable: 6 m		
	Teaching pendant to controller connection cable: 5 m		

Appendix G Stopping Time and Distance

Stopping time and distance for stop category 1

The robot configuration to measure the stopping time and the stopping distance for the stop category 1 is as follows:

- Position: Maximum load position (the position of the robot arm fully stretched horizontally to make the maximum load)
- Speed: Maximum joint speed (maximum speed of 180°/sec which can be generated at the robot joint)
- Payload: Maximum load possible to be installed on the TCP (3 kg)

The behavior to measure the stopping distance for the joint J1 was driven in parallel to the ground and joints J2 and J3 were driven perpendicular to the ground. The stop category 1 was performed when each joint reached its maximum speed.

It takes 0.03 sec for the brake to be engaged for deceleration after the stop signal is detected.

	Stopping Distance (deg.)	Stopping Time (sec.)
Joint J1	23.17	0.200
Joint J2	23.35	0.202
Joint J3	23.41	0.203

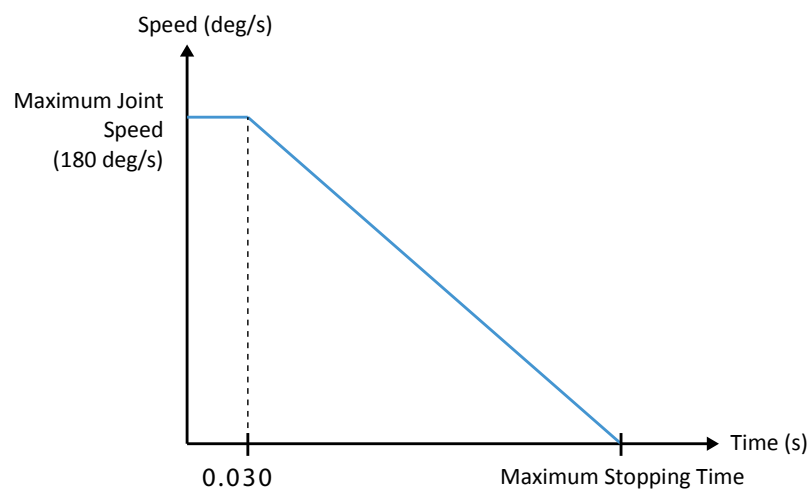

Stopping time for stop category 1

The robot configuration to measure the stopping time for the stop category 1 is as follows:

- Position: Maximum load position (the position of the robot arm fully stretched horizontally to make the maximum load)
- Speed: Maximum joint speed (maximum speed of 180°/sec which can be generated at the robot joint)
- Payload: Maximum load possible to be installed on the TCP (3 kg)

Create a behavior to stop regardless of the speed and the payload so that it comes to a full stop after a certain period (0.250sec).



GDL: +52 (33)-3854-5975
+52 (33)-3823-4349
USA: +1 (619) 616-7350



Av. Fray Antonio Alcalde 1822
Miraflores, 44270
Guadalajara, Jal.



www.logicbus.com.mx
tienda.logicbus.com.mx

soporte@logicbus.com

