

# IIOT

Technology is Making Life Smarter



GDL: +52 (33)-3854-5975  
+52 (33)-3823-4349  
USA: +1 (619) 616-7350



Av. Fray Antonio Alcalde 1822  
Miraflores, 44270  
Guadalajara, Jal.



[www.logicbus.com.mx](http://www.logicbus.com.mx)  
[tienda.logicbus.com.mx](http://tienda.logicbus.com.mx)

[soporte@logicbus.com](mailto:soporte@logicbus.com)



L215A-WH25L0-RT  
21.5" Touch Monitor



# Industrial Monitor

CH2656

1920 x 1920

CH3405

2560 x 1080



With the stylish design and extra-small foot print, it creates more work space and pleasantness on the desk. It brilliantly presents crystal-clear images and text. Slim design, light weight and fast response time flat display monitor which support various manufacture standards as well as multitude of applications.

# A rugged stand for your monitor

**ST01**



**ST02**



**ST03**



**ST05**



- Aluminum die-casting design
- Tilt to flat 3° ~ 79°
- VESA 75 x 75 mm, 100 x 100 mm supported
- Cable management
- Power adapter management

## Specifications

Size	Model Number	Active Area	Native Resolution	Brightness/Contrast	Response Time	Viewing Angle	Power Consumption
<b>4:3 Squire screen</b>							
10.4"	L1043-SN35C0-RT	211.2(H) x 158.4(V)mm	800(H) x 600(V)	350cd/m <sup>2</sup> /400:1	≤35 ms	(H)140° (V)120°	20 watt
10.4"	L1043-XN40C0-RT	211.2(H) x 158.4(V)mm	1024(H) x 768(V)	400cd/m <sup>2</sup> /500:1	≤35 ms	(H)140° (V)120°	20 watt
12.1"	L1203-XN18C0-RT	245.8(H) x 184.3 (V)mm	1024(H) x 768(V)	180cd/m <sup>2</sup> /550:1	≤16 ms	(H)90° (V)65°	20 watt
12.1"	L1203-XN40C0-RT	245.8(H) x 184.3 (V)mm	1024(H) x 768(V)	400cd/m <sup>2</sup> /700:1	≤16 ms	(H)90° (V)65°	20 watt
15"	L1585-XN25C0-RT	304.13(H) x 228.10(V)mm	1024(H) x 768(V)	250cd/m <sup>2</sup> /600:1	≤12 ms	(H)130° (V)100°	20 watt
15"	L1585-XN40C0-RT	304.13(H) x 228.10(V)mm	1024(H) x 768(V)	400cd/m <sup>2</sup> /800:1	≤12 ms	(H)130° (V)100°	20 watt
17"	L1783-EN30C0-RT	337.92(H) x 270.34(V)mm	1280(H) x 1024(V)	300cd/m <sup>2</sup> /800:1	≤5 ms	(H)160° (V)160°	30 watt
17"	L1785-EN30C0-RT	337.92(H) x 270.34(V)mm	1280(H) x 1024(V)	300cd/m <sup>2</sup> /800:1	≤5 ms	(H)160° (V)160°	30 watt
19"	L1983-EN30C0-RT	376.3(H) x 301.1(V)mm	1280(H) x 1024(V)	300cd/m <sup>2</sup> /800:1	≤5 ms	(H)160° (V)160°	32 watt
19"	L1985-EN30C0-RT	376.3(H) x 301.1(V)mm	1280(H) x 1024(V)	300cd/m <sup>2</sup> /800:1	≤5 ms	(H)160° (V)160°	32 watt
<b>16:9 Wide screen</b>							
10.1"	L1016-WE20L0-RT	216.96(H) x 135.6(V)mm	1280(H) x 800(V)	200cd/m <sup>2</sup> /500:1	≤16 ms	(H)130° (V)110°	8.25 watt
10.1"	L1016-WU35L0-RT	216.81(H) x 135.5(V)mm	1920(H) x 1200(V)	350cd/m <sup>2</sup> /600:1	≤25 ms	(H)160° (V)160°	8.75 watt
15.6"	L1563-WX25C0-PCT	344.23(H) x 193.54(V)mm	1366(H) x 768(V)	250cd/m <sup>2</sup> /1000:1	≤8 ms	(H)90° (V)65°	15 watt
15.6"	L1565-WX25C0-PCT	344.23(H) x 193.54(V)mm	1366(H) x 768(V)	250cd/m <sup>2</sup> /1000:1	≤8 ms	(H)90° (V)65°	15 watt
17"	L17W3-WP40C0-RT	367.2(H) x 229.5(V)mm	1440(H) x 900(V)	400cd/m <sup>2</sup> /600:1	≤12 ms	(H)140° (V)120°	18 watt
17"	L17W5-WP40C0-RT	367.2(H) x 229.5(V)mm	1440(H) x 900(V)	400cd/m <sup>2</sup> /600:1	≤12 ms	(H)140° (V)120°	18 watt
18.5"	L1855-WX30C0-RT	409.8(H) x 203.4(V)mm	1366(H) x 768(V)	300cd/m <sup>2</sup> /1000:1	≤5 ms	(H)170° (V)160°	22 watt
21"	L215A5-WH25L0-RT	476.64(H) x 268.11(V)mm	1920(H) x 1080(V)	250cd/m <sup>2</sup> /1000:1	≤5 ms	((H)170° (V)160°	26.25 watt
24"	L241A3-WU30L0-RT	518.4(H) x 324.0(V) mm	1920(H) x 1200(V)	300cd/m <sup>2</sup> /1000:1	≤14 ms	(H)178° (V)178°	40 watt



# Touch Solutions

The stable removable base is engineered for the physical demands of everyday touch screen use. User friendly controls for easy adjustments. Now you can operate keyboard and mouse free, use your fingers and feel the power under your fingers. Suitable for POS display, information board, industrial field, medical and transportation applications.

**ZPM104A**



**ZPM150A**



### PCT Touch

Capacitive touch is based on static electricity inducing a capacitive voltage. A capacitive touch screen contains two ITO layers, hard coat layers, and two sensing arrays (X & Y). As X and Y arrays exist on different layers, when electrical is induced on one of the arrays through the drive line, the other array and the circuitry will detect the values of capacitance. The controller sends electrical currents to the drive lines on different layers to create specific nodes. When a finger touches the panel, after that controller will catch the value of capacitance between nodes and drive lines to point out the exact location.

- Long Life
- Multi-Touch
- Excellent Optical Properties
- Ease to Integrate

Now, the 10-point multi-touch PCT for 10.1", 13.3", 15.6", 18.5", 19", 21.5", 23", & 24" sizes are coming soon.

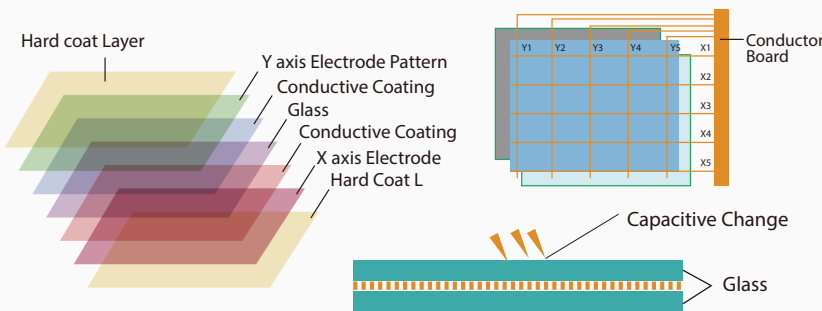

### Analog Resistive Touch

Resistive technology is suitable for a variety of applications and environments. A Resistive Touch Panel consists of two transparent resistive ITO layers (conductive and resistive layers) consisting of a sensor.

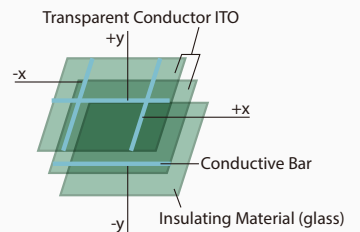

### SAW Touch

Surface Acoustic Wave (SAW) is used with acoustic waves traveling over the surface. It contains substrate material, 4 transducers, an array of reflectors, and is attached to the beveled edge of the glass for X and Y axes. (2 for transmitting and 2 for receiving) Each of the transmitting transducers (X and Y) is located at horizontal and vertical edges. Each of the receiving transducers (X and Y) is located at the opposite edges. When the user touches the screen, some of the energy is absorbed after that transmitting of X and Y will detect the reducing energy and respond to the receiving transducers of X and Y.

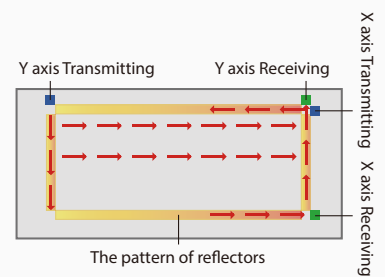

### Infrared Touch

Infrared technology used on touch panels consists of rows of LEDs and transistors on each edge of the touch frame. Each light-emitting diode creates a light beam and sends it to the other side of the light detector. These light beams form an IR light grid. When IR light beams are interrupted at any location, the controller will calculate X distance and Y distance and then send the exact position to the computer.

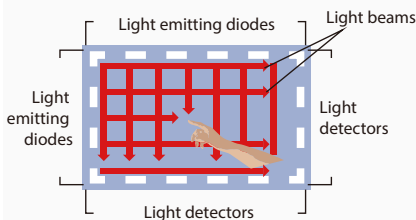

### Optical Touch

An optical touch panel consists of two reflectors and a light source (LEDs). When an object interrupts the infrared light, and then the two optical sensors will induce any movement of the object on the screen. The controller can calculate X and Y and then send the exact position to the computer.

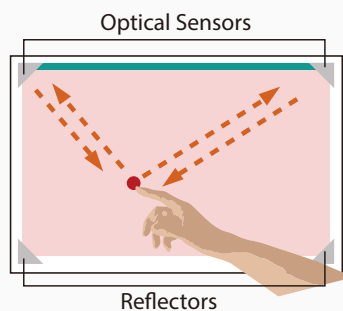

# Metal Housing

Full range Industrial Monitor fit for different applications.



Zero Bezel



Flush Mount



Panel Mount



Open Frame



Chassis Mount



Chassis



Rack Mount



Size	Model Number	Active Area	Native Resolution	Brightness/Contrast	Response Time	Viewing Angle	Power Consumption
<b>4:3 Squire screen</b>							
5.7"	0576-VN40L0	115.2(H) x 86.4(V)mm	640(H) x 480(V)	400cd/m <sup>2</sup> /800:1	≤25ms	(H)160° (V)140°	8.25 watt
6.5"	0656-VN40L0	132.48(H) x 99.36(V)mm	640(H) x 480(V)	400cd/m <sup>2</sup> /500:1	≤25ms	(H)140° (V)120°	9.875 watt
8.4"	0846-SN35L0	170.4(H) x 128.8(V)mm	800(H) x 600(V)	350cd/m <sup>2</sup> /400:1	≤35ms	(H)140° (V)120°	8.68 watt
9.7"	0975-XN35L0	196.608(H) x 147.456(V)mm	1024(H) x 768(V)	350cd/m <sup>2</sup> /500:1	≤35ms	(H)140° (V)120°	8.3 watt
10.4"	1045-XN40L0	210.4(H) x 157.8 (V)mm	1024(H) x 768(V)	400cd/m <sup>2</sup> /1200:1	≤35ms	(H)176° (V)176°	9.375 watt
12.1"	1205-SN25L0	246.0(H) x 184.5(V)mm	800(H) x 600(V)	250cd/m <sup>2</sup> /600:1	≤35ms	(H)140° (V)120°	21.9 watt
12.1"	1205-XN35L0	245.76(H) x 184.32(V)mm	1024(H) x 768(V)	350cd/m <sup>2</sup> /700:1	≤20ms	(H)160° (V)160°	23.75 watt
15"	1505-XN25L0	304.13(H) x 228.10 (V)mm	1024(H) x 768(V)	250cd/m <sup>2</sup> /500:1	≤12ms	(H)130° (V)100°	20 watt
17"	1705-EN25L0	337.92(H) x 270.34(V)mm	1280(H) x 1024(V)	250cd/m <sup>2</sup> /800:1	≤5ms	(H)160° (V)160°	32.5 watt
19"	1905-EN25L0	376.3(H) x 301.1(V)mm	1280(H) x 1024(V)	250cd/m <sup>2</sup> /800:1	≤5ms	(H)160° (V)160°	32.5 watt
20.1"	2005-UN40L0	408(H) x 306(V) mm	1600(H) x 1200(V)	400cd/m <sup>2</sup> /800:1	≤8ms	(H)160° (V)160°	40 watt
21.3"	2135-QX80L0	433.152(H) x 324.864(V)mm	2048(H) x 1536(V)	800cd/m <sup>2</sup> /1200:1	≤25ms	(H)178° (V)178°	111.25 watt
23.1"	2316-UN40L0	470.4(H) x 352.8(V)mm	1600(H) x 1200(V)	400cd/m <sup>2</sup> /600:1	≤8ms	(H)160° (V)160°	117.5watt
26"	2625-SQ30L2	491.8(H) x 491.8(V)mm	1920(H) x 1920(V)	400cd/m <sup>2</sup> /600:1	≤8ms	(H)178° (V)178°	130.5watt
<b>16:9 Wide screen</b>							
7"	0706-WV40L0	152.40(H) x 91.44(V)mm	800(H) x 480(V)	400cd/m <sup>2</sup> /300:1	≤16ms	(H)120° (V)100°	9.625 watt
10.1"	1016-WS20L0	222.72(H) x 152.28(V)mm	1024(H) x 600(V)	200cd/m <sup>2</sup> /650:1	≤10ms	(H)90° (V)65°	8.75 watt
10.1"	1016-WE20L0	216.96(H) x 135.6(V) mm	1280(H) x 800(V)	200cd/m <sup>2</sup> /500:1	≤16ms	(H)130° (V)110°	8.75 watt
10.1"	1016-WX20L0	222.72(H) x 125.28(V) mm	1366(H) x 768(V)	200cd/m <sup>2</sup> /500:1	≤16ms	(H)90° (V)50°	8.25 watt
10.1"	1016-WU35L0	216.81(H) x 135.5(V) mm	1920(H) x 1200(V)	350cd/m <sup>2</sup> /600:1	≤25ms	(H)160° (V)160°	8.75 watt
12.1"	12W5-WE35L0	261.12(H) x 163.20 (V)mm	1280(H) x 800(V)	350cd/m <sup>2</sup> /350:1	≤15ms	(H)130° (V)115°	10 watt
15.4"	1545-WEA0L0	331.2(H) x 207.0 (V)mm	1280(H) x 800(V)	1000cd/m <sup>2</sup> /400:1	≤16ms	(H)90° (V)65°	17 watt
15.6"	1565-WX20L0	344.232(H) x193.536(V)mm	1366(H) x 768(V)	200cd/m <sup>2</sup> /500:1	≤8ms	(H)90° (V)50°	10.625 watt
17"	17W5-WPA0L0	367.2(H) x 229.5(V)mm	1440(H) x 900(V)	1000cd/m <sup>2</sup> /800:1	≤8ms	(H)130° (V)100°	11 watt
17.3"	1735-WH30L0	381.888(H) x 214.812(V) mm	1920(H) x 1080(V)	300cd/m <sup>2</sup> /500:1	≤8ms	(H)90° (V)50°	15 watt
18.5"	1855-WX25L0	409.8(H) x 230.4(V)mm	1366(H) x 768(V)	250cd/m <sup>2</sup> /1000:1	≤5ms	(H)170° (V)160°	22 watt
19"	19W5-WP25L0	408.24(H) x 255.15(V)mm	1440(H) x 900(V)	250cd/m <sup>2</sup> /1000:1	≤5ms	(H)170° (V)160°	30 watt
21.5"	2155-WH25L0	476.64(H) x 268.11(V)mm	1920(H) x 1080(V)	250cd/m <sup>2</sup> /1000:1	≤5ms	(H)170° (V)160°	26 watt
22"	2205-WM25L0	473.8(H) x 296.1(V)mm	1680(H) x 1050(V)	300cd/m <sup>2</sup> /1000:1	≤5ms	(H)170° (V)160°	36 watt
24"	2405-WH25L0	531.36(H) x 298.89(V)mm	1920(H) x 1080(V)	250cd/m <sup>2</sup> /1000:1	≤2ms	(H)170° (V)160°	50 watt
24"	2415-WU30L0	518.4(H) x 324.0(V)mm	1920(H) x 1200(V)	300cd/m <sup>2</sup> /1000:1	≤6ms	(H)178° (V)178°	85 watt
27"	2705-WH30L0	597.89(H) x 336.31(V)mm	1920(H) x 1080(V)	300cd/m <sup>2</sup> /1000:1	≤3.4ms	(H)178° (V)178°	35 watt
27"	2705-QD35L0	596.74(H) x 335.66(V)mm	2560(H) x 1440(V)	350cd/m <sup>2</sup> /1000:1	≤5.5ms	(H)178° (V)178°	100.5 watt
32"	3205-WX35L0	697.69(H) x 392.26(V)mm	1920(H) x 1080(V)	350cd/m <sup>2</sup> /2000:1	≤6ms	(H)178° (V)178°	130 watt
32"	3205-QD35L0	698.4(H) x 392.9(V)mm	2560(H) x 1440(V)	350cd/m <sup>2</sup> /3000:1	≤6ms	(H)178° (V)178°	145 watt
34"	3405-WF30L2	820.8 (H) x 361.0 (V)mm	2560(H) x 1080(V)	300cd/m <sup>2</sup> /3000:1	≤6ms	(H)178° (V)178°	175 watt
42"	4204-WH35L0	930.24(H) x 523.26(V)mm	1920(H) x 1080(V)	350cd/m <sup>2</sup> /3000:1	≤8ms	(H)178° (V)178°	202 watt
46"	4604-WH35L0	1018.08(H) x 572.67(V)mm	1920(H) x 1080(V)	350cd/m <sup>2</sup> /3000:1	≤8ms	(H)178° (V)178°	190 watt
50"	5004-WH35L0	1101.8(H) x 622.4(V) mm	1920(H) x 1080(V)	350cd/m <sup>2</sup> /3000:1	≤8ms	(H)178° (V)178°	280 watt
55"	5504-WH35L0	1209.6(H) x 680.4 (V)mm	1920(H) x 1080(V)	350cd/m <sup>2</sup> /3000:1	≤8ms	(H)178° (V)178°	400 watt
65"	6504-WH35L0	1428.48(H) x 803.52 (V)mm	1920(H) x 1080(V)	350cd/m <sup>2</sup> /3000:1	≤8ms	(H)178° (V)178°	630 watt



# Medical

Winsonic provides to meet the rising demands for large-sized viewing and ultra-high definition, 27 / 32 / 42 / 55 / 65 / 75 / 85 inch LCD monitor 4K2K pixel resolution should attractive from video / graphics professionals.

The 4K2K monitor also benefits from a wide 178 degree viewing angle, the monitor is compatible with HDMI specifications, allowing for single cable PC connection. Each color is performed the finest precision, rich and liveliest colors in every detail.

## MEDICAL DISPLAY

4K2K ultra resolution(3840 x 2160) for medical application 27", 32" ... models available





# Specifications

Size	Model Number	Active Area	Native Resolution	Brightness/Contrast	Response Time	Viewing Angle	Power Consumption
<b>16:9 Wide screen</b>							
27"	2705-QD35L0	596.74(H) x 335.66(V)mm	2560(H) x 1440(V)	350cd/m <sup>2</sup> /1000:1	≤6ms	(H)178° (V)178°	42.5 watt
32"	3205-QD35L0	698.4(H) x 392.9(V)mm	2560(H) x 1440(V)	350cd/m <sup>2</sup> /3000:1	≤6ms	(H)178° (V)178°	73.5 watt
32"	3205-QF30L0	698.4(H) x 392.85(V)mm	3840(H) x 2160(V)	300cd/m <sup>2</sup> /3000:1	≤9.5ms	(H)178° (V)178°	73.5 watt
42"	4204-QF35L0	919.29(H) x 517.104(V)mm	3840(H) x 2160(V)	350cd/m <sup>2</sup> /5000:1	≤9.5ms	(H)178° (V)178°	141.25 watt
55"	5504-QF35L0	1209.6(H) x 680.4(V) mm	3840(H) x 2160(V)	350cd/m <sup>2</sup> /4000:1	≤6.5ms	(H)178° (V)178°	160 watt
65"	6504-QF35L0	1428.48(H) x 803.52(V) mm	3840(H) x 2160(V)	350cd/m <sup>2</sup> /5000:1	≤6.5ms	(H)176° (V)176°	260 watt
75"	7504-QF35L0	1650.24(H) x 928.26(V) mm	3840(H) x 2160(V)	350cd/m <sup>2</sup> /4000:1	≤8ms	(H)178° (V)178°	340 watt
85"	8504-QF35L0	1904(H) x 1096(V) mm	3840(H) x 2160(V)	350cd/m <sup>2</sup> /1600:1	≤8ms	(H)178° (V)178°	408 watt

## Open Frame



## Chassis Mount



## Chassis



## Panel Mount





## CHX4207

### Chassis Stretched Display

#### Features

- High Brightness 1500-2500nits
- Sunlight Readable



# Stretched Display

Our range of Stretched LCD Monitors are specially cut offering a super wide display format which offers an innovative and fresh approach to grab the public's attention. These stretched format display products, also known as BAR displays, are available in a variety of sizes and aspect ratios, with sunlight readable options, open frame models, making them an ideal solution for digital signage, gaming and wayfinding style applications.

#### Open Frame Stretched Display



#### Full IP66 Stretched Display



# Specifications

Size	Model Number	Active Area	Native Resolution	Brightness/Contrast	Response Time	Viewing Angle	Power Consumption
<b>Chassis Stretched Display</b>							
12.3", 1/2 Cut	CHX1237-X130C0	291.84(H) x 109.44(V)mm	1280(H) x 480(V)	300cd/m <sup>2</sup> /400:1	≤10 ms	(H)130° (V)110°	20 watt
15.1", 1/4 Cut	CHX1507-X430L0	376.32(H) x 72.91(V)mm	1280(H) x 248(V)	300cd/m <sup>2</sup> /2000:1	≤8 ms	(H)178° (V)178°	20 watt
19", 1/3 Cut	CHX1907-X330L0	473.76(H) x 96.44 (V)mm	1680(H) x 342(V)	300cd/m <sup>2</sup> /2000:1	≤8 ms	(H)140° (V)120°	30 watt
28", 1/3 Cut	CHX2807-X360L0	698.3(H) x 130.9(V)mm	1920(H) x 358(V)	600cd/m <sup>2</sup> /2000:1	≤8 ms	(H)178° (V)178°	30 watt
28.5", 1/2 Cut	CHX2857-X1A0L0	698.4(H) x 196.42(V) mm	1920(H) x 540(V)	1000cd/m <sup>2</sup> /5000:1	≤9 ms	(H)176° (V)176°	30 watt
37.9", 1/2 Cut	CHX3807-X150L0	930.24(H) x 243.219(V)mm	1920(H) x 502(V)	500cd/m <sup>2</sup> /1400:1	≤5 ms	(H)178° (V)178°	100 watt
38", 1/2 Cut	CHX3817-X1A5L0	930.24(H) x 260.66(V)mm	1920(H) x 538(V)	1500cd/m <sup>2</sup> /4000:1	≤8 ms	(H)176° (V)176°	100 watt
38", 1/2 Cut	CHX3827-X170L0	930.24(H) x 276.16(V) mm	1920(H) x 570(V)	700cd/m <sup>2</sup> /400:1	≤8 ms	(H)178° (V)178°	100 watt
42", 1/3 Cut	CHX4207-X150L0	1039.68(H)×259.92(V) mm	1920(H) x 480(V)	500cd/m <sup>2</sup> /3000:1	≤8 ms	(H)178° (V)178°	140 watt
<b>Open Frame Stretched Display</b>							
12.3", 1/2 Cut	OFX1237-X130C0	291.84(H) x 109.44(V)mm	1280(H) x 480(V)	300cd/m <sup>2</sup> /400:1	≤10 ms	(H)130° (V)110°	20 watt
15.1", 1/4 Cut	OFX1507-X430L0	376.32(H) x 72.91(V)mm	1280(H) x 248(V)	300cd/m <sup>2</sup> /2000:1	≤8 ms	(H)178° (V)178°	20 watt
19", 1/3 Cut	OFX1907-X330L0	473.76(H) x 96.44 (V)mm	1680(H) x 342(V)	300cd/m <sup>2</sup> /2000:1	≤8 ms	(H)140° (V)120°	30 watt
28", 1/3 Cut	OFX2807-X360L0	698.3(H) x 130.9(V)mm	1920(H) x 358(V)	600cd/m <sup>2</sup> /2000:1	≤8 ms	(H)178° (V)178°	30 watt
28.5", 1/2 Cut	OFX2857-X1A0L0	698.4(H) x 196.42(V) mm	1920(H) x 540(V)	1000cd/m <sup>2</sup> /5000:1	≤9 ms	(H)176° (V)176°	30 watt
37.9", 1/2 Cut	OFX3807-X150L0	930.24(H) x 243.219(V)mm	1920(H) x 502(V)	500cd/m <sup>2</sup> /1400:1	≤5 ms	(H)178° (V)178°	100 watt
38", 1/2 Cut	OFX3817-X1A5L0	930.24(H) x 260.66(V)mm	1920(H) x 538(V)	1500cd/m <sup>2</sup> /4000:1	≤8 ms	(H)176° (V)176°	100 watt
38", 1/2 Cut	OFX3827-X170L0	930.24(H) x 276.16(V) mm	1920(H) x 570(V)	700cd/m <sup>2</sup> /400:1	≤8 ms	(H)178° (V)178°	100 watt
42", 1/3 Cut	OFX4207-X150L0	1039.68(H)×259.92(V) mm	1920(H) x 480(V)	500cd/m <sup>2</sup> /3000:1	≤8 ms	(H)178° (V)178°	140 watt
<b>Full IP66 Stretched Display</b>							
12.3", 1/2 Cut	FCHX1237-X130C0	291.84(H) x 109.44(V)mm	1280(H) x 480(V)	300cd/m <sup>2</sup> /400:1	≤10 ms	(H)130° (V)110°	20 watt
15.1", 1/4 Cut	FCHX1507-X430L0	376.32(H) x 72.91(V)mm	1280(H) x 248(V)	300cd/m <sup>2</sup> /2000:1	≤8 ms	(H)178° (V)178°	20 watt
19", 1/3 Cut	FCHX1907-X330L0	473.76(H) x 96.44 (V)mm	1680(H) x 342(V)	300cd/m <sup>2</sup> /2000:1	≤8 ms	(H)140° (V)120°	30 watt
28", 1/3 Cut	FCHX2807-X360L0	698.3(H) x 130.9(V)mm	1920(H) x 358(V)	600cd/m <sup>2</sup> /2000:1	≤8 ms	(H)178° (V)178°	30 watt
28.5", 1/2 Cut	FCHX2857-X1A0L0	698.4(H) x 196.42(V) mm	1920(H) x 540(V)	1000cd/m <sup>2</sup> /5000:1	≤9 ms	(H)176° (V)176°	30 watt
37.9", 1/2 Cut	FCHX3807-X150L0	930.24(H) x 243.219(V)mm	1920(H) x 502(V)	500cd/m <sup>2</sup> /1400:1	≤5 ms	(H)178° (V)178°	100 watt
38", 1/2 Cut	FCHX3817-X1A5L0	930.24(H) x 260.66(V)mm	1920(H) x 538(V)	1500cd/m <sup>2</sup> /4000:1	≤8 ms	(H)176° (V)176°	100 watt
38", 1/2 Cut	FCHX3827-X170L0	930.24(H) x 276.16(V) mm	1920(H) x 570(V)	700cd/m <sup>2</sup> /400:1	≤8 ms	(H)178° (V)178°	100 watt
42", 1/3 Cut	CHX4207-X150L0	1039.68(H)×259.92(V) mm	1920(H) x 480(V)	500cd/m <sup>2</sup> /3000:1	≤8 ms	(H)178° (V)178°	140 watt

# High Brightness



Winsonic has continually been developing a sunlight readable LCD Display solution. The company offers a full range of high brightness / sunlight readable LCD display solutions to meet consumer demand. With more and more outdoor LCD Display applications in the marketplace, the readability & sustainability of the LCD panel under direct sunlight is becoming more vital. But there are several obstacles to overcome in order to provide a good LCD display solution under direct sunlight, such as the overheat issue, water-proof issue, readability issue, and the sustainability issue.

## The factors that affect sunlight readability

Sunlight visibility of a display depends on the differences between the lamination (brightness) and the illumination (ambient light shining on the display).

Because the TFT LCD display does not emit light, it needs an external light source ( backlight ). The brightness of an LCD display is much less than the sun, which causes the LCD displays to barely be viewable in a bright environment, especially under direct sunlight.

## Light efficiency in each layer

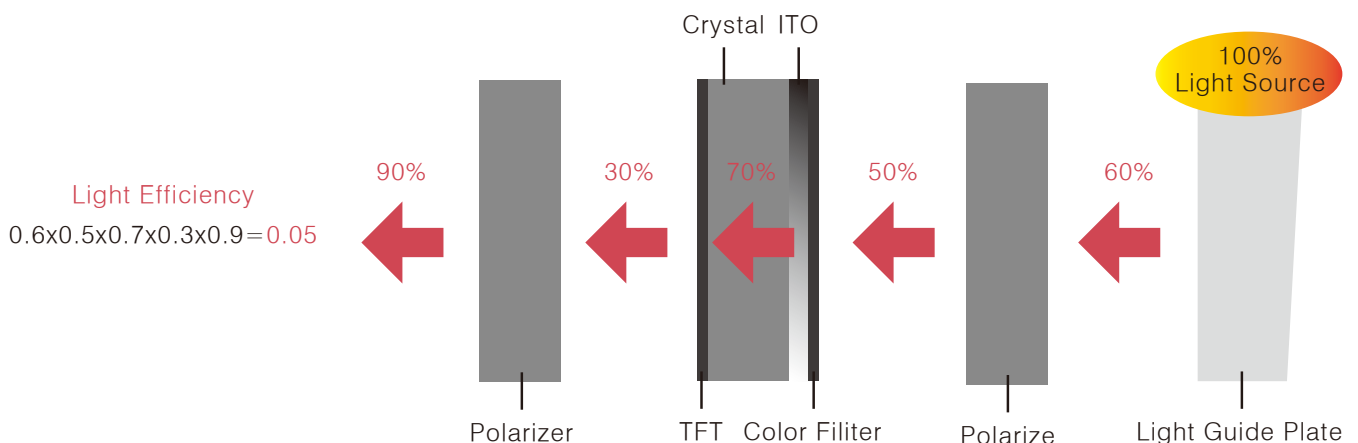

# Sunlight Readable

- 2000 nits



**1** High brightness LCD display monitors luminance up to 1500 nits ~ 2000 nits for superior performance in outdoor direct sunlight applications. These LCD displays are available in large sizes.

**2** With IP66 stainless enclosure, it provides complete protection against harmful water and dust.

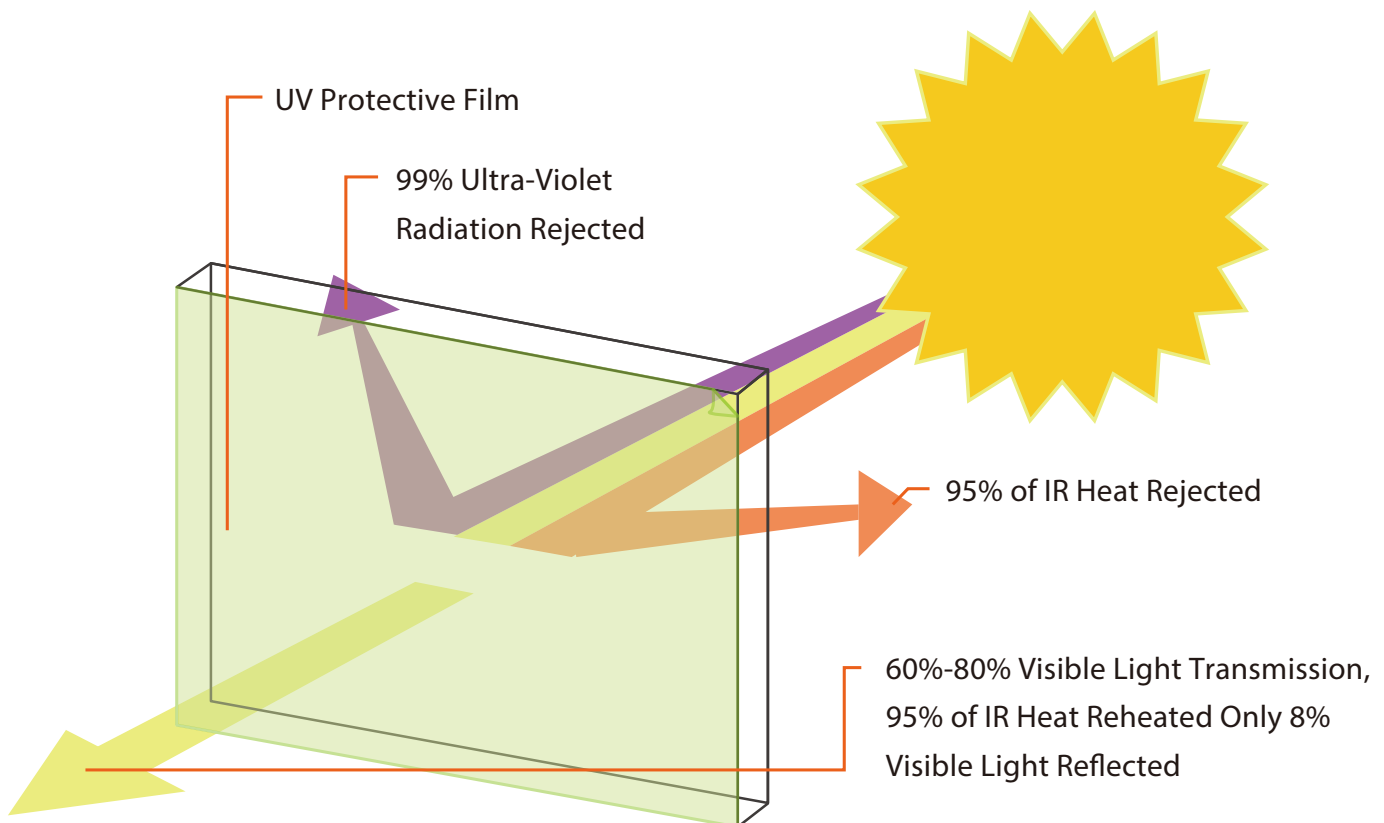



# Water Resistance

## IP65 Front

Protect the LCD monitor against everyday hazard with the IP65 water and dust proof front side enclosures. High degree of protection against rain, falling dirt, sleet, snow, dust and water means no more liquid spill or dust ingress to damage the display.

## Applications

Industrial & factory automation

Outdoor kiosk

Medical equipment

Yacht on-deck display

Shower room entertainment display

## Full IP66

With IP66 Full Stainless, it provides complete protection against outside contact with internal electronic or electrical components, protection against harmful deposits of dust, and strong water jets being squirted from any direction against the enclosure. Available in sizes from 5.7" to 85"

Outdoor kiosk

harsh industrial environment

Shower room display

Yacht on-deck display

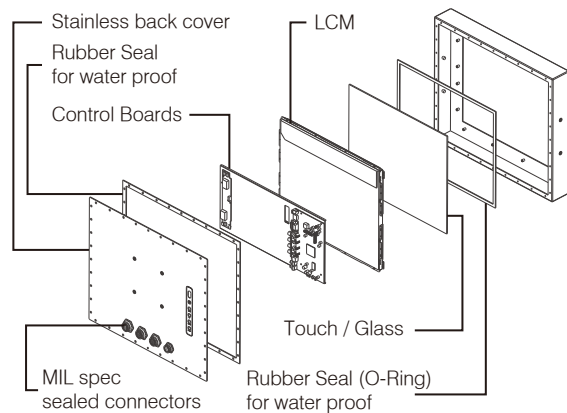
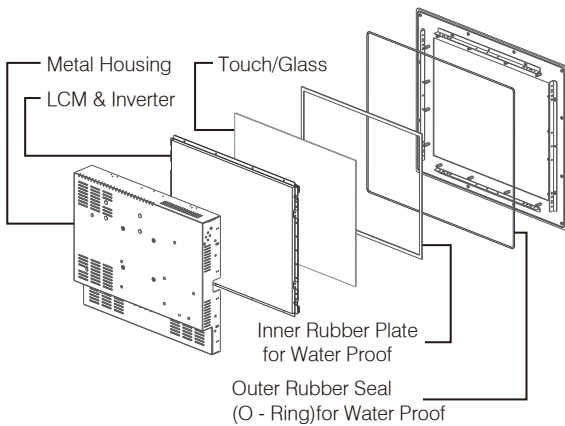

# IP67

Totally protected against dust & the effects of temporary immersion to water between 15 cm and 1m. Duration of test 30 minutes.



# Panel Mount IP66 Monitor

Winsonic offers all-around IP66 protection with over coating showing mechanical stability and reliability. Screen size available from 10.4"~24".

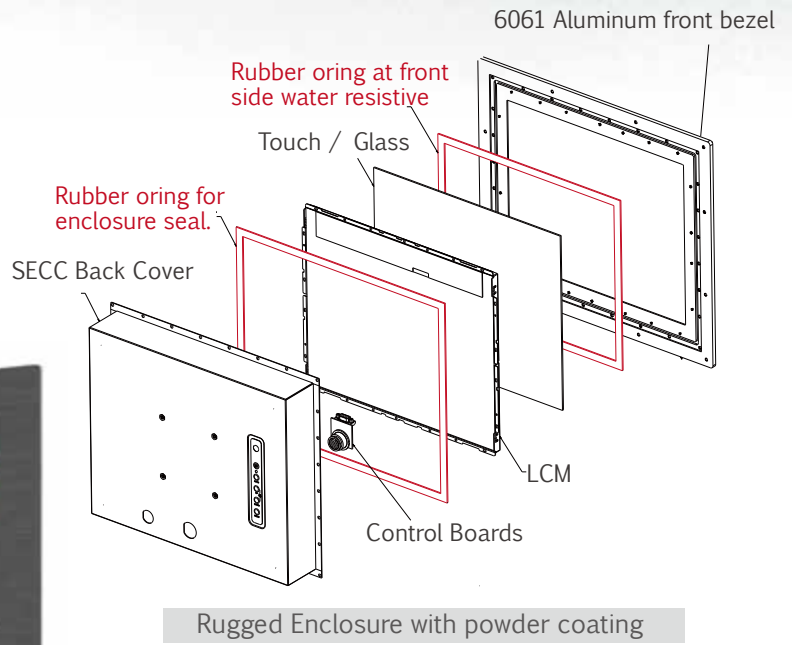

# Full IP66 Yoke Mount

Rugged mount allowing swivel movement. Pipe cable management easy to protect all the cables.





# Industrial Panel PC

Full range industrial Panel PC fit for different applications.



Zero Bezel



Chassis



Open Frame



Chassis Mount



Panel Mount



Full IP66 Chassis



## Industrial All In One Panel PCI PC

Panel PC with PCI expansion slots that are fully functional for many industrial fields such as automation, transportation, and food & beverage market.



TFT LCD flat panel display  
Bezel Protection



1 x PCI Slot (Low profile)  
Panel PC with PCI expansion slots support TFT LCD flat panel display, front bezel protection.

## Reduce vibration

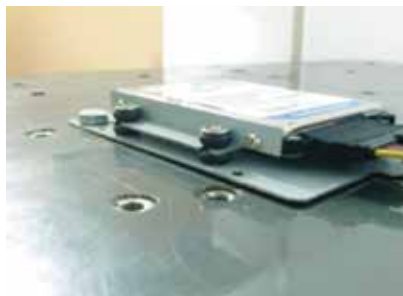

Amplitude	0.20mm	0.25mm	0.35mm	0.50mm	0.75mm	1.00mm	1.25mm	1.50mm
55Hz	1.21g	1.52g	2.13g	3.04g	4.57g	6.09g	7.61g	9.14g
Result	V	V	V	V	V	V	X	X

- Reduce vibration to reduce case noise
- Simply attach to a standard 2.5" hard drive
- Silicon rubber construction



# Fanless Panel PC

The Winsonic fanless panel PC comes with incredible customer service and is an all-in-one solution for interactive kiosks in hotels, airports, and public transports. Not to mention, the PC is perfect for retail signage displays in shopping malls and restaurants.

The panel PC looks wonderful in public, especially in areas where the PC is installed above eye-level locations in vertical orientation, such as digital menus in restaurants and exhibit displays in trade shows.

## Perfect Heat Conductive & Perfect Heat float



The thermal module helps by transferring internal energy to the outer heat sink.



# Specifications

Size	Model Number	Active Area	Native Resolution	Brightness/Contrast	Response Time	Viewing Angle	Power Consumption
<b>4:3 Squire screen</b>							
5.7"	0576-VN40L0	115.2(H) x 86.4(V)mm	640(H) x 480(V)	400cd/m <sup>2</sup> /800:1	≤25ms	(H)160° (V)140°	8.25 watt
6.5"	0656-VN40L0	132.48(H) x 99.36(V)mm	640(H) x 480(V)	400cd/m <sup>2</sup> /500:1	≤25ms	(H)140° (V)120°	9.875 watt
8.4"	0846-SN35L0	170.4(H) x 128.8(V)mm	800(H) x 600(V)	350cd/m <sup>2</sup> /400:1	≤35ms	(H)140° (V)120°	8.68 watt
9.7"	0975-XN35L0	196.608(H) x 147.456(V)mm	1024(H) x 768(V)	350cd/m <sup>2</sup> /500:1	≤35ms	(H)140° (V)120°	8.3 watt
10.4"	1045-XN40L0	210.4(H) x 157.8 (V)mm	1024(H) x 768(V)	400cd/m <sup>2</sup> /1200:1	≤35ms	(H)176° (V)176°	9.375 watt
12.1"	1205-SN25L0	246.0(H) x 184.5(V)mm	800(H) x 600(V)	250cd/m <sup>2</sup> /600:1	≤35ms	(H)140° (V)120°	21.9 watt
12.1"	1205-XN35L0	245.76(H) x 184.32(V)mm	1024(H) x 768(V)	350cd/m <sup>2</sup> /700:1	≤20ms	(H)160° (V)160°	23.75 watt
15"	1505-XN25L0	304.13(H) x 228.10 (V)mm	1024(H) x 768(V)	250cd/m <sup>2</sup> /500:1	≤12ms	(H)130° (V)100°	20 watt
17"	1705-EN25L0	337.92(H) x 270.34(V)mm	1280(H) x 1024(V)	250cd/m <sup>2</sup> /800:1	≤5ms	(H)160° (V)160°	32.5 watt
19"	1905-EN25L0	376.3(H) x 301.1(V)mm	1280(H) x 1024(V)	250cd/m <sup>2</sup> /800:1	≤5ms	(H)160° (V)160°	32.5 watt
21.3"	2135-QX80L0	433.152(H) x 324.864(V)mm	2048(H) x 1536(V)	800cd/m <sup>2</sup> /1200:1	≤25ms	(H)178° (V)178°	111.25 watt
23.1"	2316-UN40L0	470.4(H) x 352.8(V)mm	1600(H) x 1200(V)	400cd/m <sup>2</sup> /600:1	≤8ms	(H)160° (V)160°	117.5watt
<b>16:9 Wide screen</b>							
7"	0706-WV40L0	152.40(H) x 91.44(V)mm	800(H) x 480(V)	400cd/m <sup>2</sup> /300:1	≤16ms	(H)120° (V)100°	9.625 watt
10.1"	1016-WS20L0	222.72(H) x 152.28(V)mm	1024(H) x 600(V)	200cd/m <sup>2</sup> /650:1	≤10ms	(H)90° (V)65°	8.75 watt
10.1"	1016-WE20L0	216.96(H) x 135.6(V) mm	1280(H) x 800(V)	200cd/m <sup>2</sup> /500:1	≤16ms	(H)130° (V)110°	8.75 watt
10.1"	1016-WX20L0	222.72(H) x 125.28(V) mm	1366(H) x 768(V)	200cd/m <sup>2</sup> /500:1	≤16ms	(H)90° (V)50°	8.25 watt
10.1"	1016-WU35L0	216.81(H) x 135.5(V) mm	1920(H) x 1200(V)	350cd/m <sup>2</sup> /600:1	≤25ms	(H)160° (V)160°	8.75 watt
12.1"	12W5-WE35L0	261.12(H) x 163.20 (V)mm	1280(H) x 800(V)	350cd/m <sup>2</sup> /350:1	≤15ms	(H)130° (V)115°	10 watt
15.4"	1545-WEA0L0	331.2(H) x 207.0 (V)mm	1280(H) x 800(V)	1000cd/m <sup>2</sup> /400:1	≤16ms	(H)90° (V)65°	17 watt
15.6"	1565-WX20L0	344.232(H) x193.536(V)mm	1366(H) x 768(V)	200cd/m <sup>2</sup> /500:1	≤8ms	(H)90° (V)50°	10.625 watt
17"	17W5-WPA0L0	367.2(H) x 229.5(V)mm	1440(H) x 900(V)	1000cd/m <sup>2</sup> /800:1	≤8ms	(H)130° (V)100°	11 watt
17.3"	1735-WH30L0	381.888(H) x 214.812(V) mm	1920(H) x 1080(V)	300cd/m <sup>2</sup> /500:1	≤8ms	(H)90° (V)50°	15 watt
18.5"	1855-WX25L0	409.8(H) x 230.4(V)mm	1366(H) x 768(V)	250cd/m <sup>2</sup> /1000:1	≤5ms	(H)170° (V)160°	22 watt
19"	19W5-WP25L0	408.24(H) x 255.15(V)mm	1440(H) x 900(V)	250cd/m <sup>2</sup> /1000:1	≤5ms	(H)170° (V)160°	30 watt
21.5"	2155-WH25L0	476.64(H) x 268.11(V)mm	1920(H) x 1080(V)	250cd/m <sup>2</sup> /1000:1	≤5ms	(H)170° (V)160°	26 watt
22"	2205-WM25L0	473.8(H) x 296.1(V)mm	1680(H) x 1050(V)	300cd/m <sup>2</sup> /1000:1	≤5ms	(H)170° (V)160°	36 watt
24"	2405-WH25L0	531.36(H) x 298.89(V)mm	1920(H) x 1080(V)	250cd/m <sup>2</sup> /1000:1	≤2ms	(H)170° (V)160°	50 watt
24"	2415-WU30L0	518.4(H) x 324.0(V)mm	1920(H) x 1200(V)	300cd/m <sup>2</sup> /1000:1	≤6ms	(H)178° (V)178°	85 watt
27"	2705-WH30L0	597.89(H) x 336.31(V)mm	1920(H) x 1080(V)	300cd/m <sup>2</sup> /1000:1	≤3.4ms	(H)178° (V)178°	35 watt
27"	2705-QD35L0	596.74(H) x 335.66(V)mm	2560(H) x 1440(V)	350cd/m <sup>2</sup> /1000:1	≤5.5ms	(H)178° (V)178°	100.5 watt
32"	3205-WX35L0	697.69(H) x 392.26(V)mm	1920(H) x 1080(V)	350cd/m <sup>2</sup> /2000:1	≤6ms	(H)178° (V)178°	130 watt
32"	3205-QD35L0	698.4(H) x 392.9(V)mm	2560(H) x 1440(V)	350cd/m <sup>2</sup> /3000:1	≤6ms	(H)178° (V)178°	145 watt
42"	4204-WH35L0	930.24(H) x 523.26(V)mm	1920(H) x 1080(V)	350cd/m <sup>2</sup> /3000:1	≤8ms	(H)178° (V)178°	202 watt
46"	4604-WH35L0	1018.08(H) x 572.67(V)mm	1920(H) x 1080(V)	350cd/m <sup>2</sup> /3000:1	≤8ms	(H)178° (V)178°	190 watt
50"	5004-WH35L0	1101.8(H) x 622.4(V) mm	1920(H) x 1080(V)	350cd/m <sup>2</sup> /3000:1	≤8ms	(H)178° (V)178°	280 watt
55"	5504-WH35L0	1209.6(H) x 680.4 (V)mm	1920(H) x 1080(V)	350cd/m <sup>2</sup> /3000:1	≤8ms	(H)178° (V)178°	400 watt
65"	6504-WH35L0	1428.48(H) x 803.52 (V)mm	1920(H) x 1080(V)	350cd/m <sup>2</sup> /3000:1	≤8ms	(H)178° (V)178°	630 watt

x86 Fanless PC Available Size from 12" to 65"



# Zero Bezel A-series

PCAP Touch Monitor & Panel-PC

Operating Vibration Test: 10 to 25Hz (X,Y,Z direction 2G 30minutes)

- Zero Bezel, True Flat, Thin design
- IP65 Front water resistance



- Available Size  
w7", w10.1", 10.4", 15", 17", 19", w21.5"





# Boards & Power

Embedded main board, is wide range used in, industrial automation, telecommunication equipment, medical equipments, etc.

## CB0M03-QM77

x86 Platform - 3.5



CPU	3rd Generation Core i7/i5/i3 22nm processors
BIOS	AMI
Graphic Chipset	Intel® QM77
System Memory	DDR3 SO-DIMM (w/o ECC), up to 8GB
I/ O Ports	2 x Display port 1 x VGA 1 x COM 2 x USB 3.0 1 x LAN
Audio	N/A
HDD	2 x SATA
Expansion	1 x Mini PCIe
Operating Temperature	-5 ~ 60°C (23 ~ 140°F)
Storage Temperature	-20 ~ 80°C (-68 ~ 176°F)
Operating Humidity	0% ~ 95% Relative Humidity, Non-condensing
Size	146mm x 102mm

## CB0M05-BayTrail

x86 Platform - 3.5



CPU	Intel® Atom Baytrail-M/D Chipset
BIOS	UEFI
Graphic Chipset	Intel® Celeron J1900
System Memory	Single Channel DDR3L 1333 MHz SDRAM
I/ O Ports	1 x COM (RS-232/422/485), 3 x COM (RS-232) 1 x HDMI, 1 x D-Sub 1 x Dual Channel 24-bit LVDS 2 x USB 3.0, 6 x USB 2.0, 2 x SATA2 Gigabit LAN : 2 x Realtek Lan
Audio	1 x Line out
HDD	2 x SATA
Expansion	1 x SO-DIMM
Operating Temperature	-5 ~ 60°C (23 ~ 140°F)
Storage Temperature	-20 ~ 80°C (-68 ~ 176°F)
Operating Humidity	0% ~ 95% Relative Humidity, Non-condensing
Size	146mm x 102mm

## CB0J07-BayTrail

x86 Platform - Mini-ITX



CPU	Intel® Atom™ Baytrail-M/D Processor
BIOS	UEFI
Graphic Chipset	Intel® Gen7 Intel® Graphics DX 11*, OGL3.2
System Memory	Dual Channel DDR3 1333 MHz SDRAM
I/O Ports	1 x VGA, 1 x HDMI 3 x COM 1 x K/B, 1 x Mouse 2 x USB 2.0, 2 x USB 3.0 2 x LAN
Audio	Mic-in, Line-out
HDD	2 x SATA
Expansion	1 x PCI (PCI Rev. 2.3 Compliant), 1 Mini PCIe1
Operating Temperature	0 ~ 60°C (32 ~ 140°F)
Storage Temperature	-40 ~ 75°C (-40 ~ 167°F)
Operating Humidity	0% ~ 90% Relative Humidity, Non-condensing
Size	170mm x 170mm

## CB0J08-H61

x86 Platform - Mini-ITX



CPU	Intel® Core i7/i5/i3/Celeron
BIOS	UEFI
Graphic Chipset	Intel® H61 Chipset
System Memory	DDR3 1600MHz, 2 x SO-DIMM, up to 16GB
I/O Ports	1 x VGA, 1 x HDMI 2 x COM 1 x K/B 6 x USB 2.0 2 x LAN
Audio	Mic-in, Line-out
HDD	4 x SATA
Expansion	1 x Mini PCIe
Operating Temperature	-5 ~ 60°C (23 ~ 140°F)
Storage Temperature	-20 ~ 80°C (-68 ~ 176°F)
Operating Humidity	0% ~ 95% Relative Humidity, Non-condensing
Size	170mm x 170mm

## CBOJ0E-H81

x86 Platform - Mini-ITX

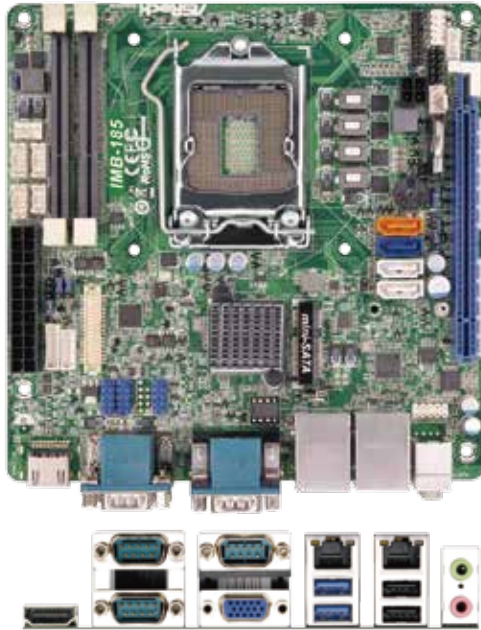

CPU	Socket LGA1150 for Intel Core i7/i5/i3/Celeron
BIOS	UEFI
Graphic Chipset	Integrated Intel® HD Graphics Built-in Visuals
System Memory	Dual Channel DDR3 1066/1333/1600 MHz SDRAM
I / O Ports	1 x VGA, 1 x HDMI 3 x COM 1 x 24 bit Dual Channel LVDS 2 x USB 2.0, 2 x USB 3.0 2 x LAN
Audio	Mic-in, Line-out
HDD	2 x SATA
Expansion	1 x PCI (PCI Rev. 2.3 Compliant), 1 Mini PClex1
Operating Temperature	0 ~ 60°C (32 ~ 140°F)
Storage Temperature	-40 ~ 75°C (-40 ~ 167°F)
Operating Humidity	0% ~ 90% Relative Humidity, Non-condensing
Size	170mm x 170mm

## CBOJ0G-Skylake

x86 Platform - Mini-ITX



CPU	Intel® Core i7 / i5 / i3 / Celeron® (Skylake-S)
BIOS	UEFI
Graphic Chipset	Intel® Gen9 Intel® Graphics DX 11/12
System Memory	2 x DDR4 SO-DIMM slots, up to 32GB 2133MHz
I / O Ports	1 x HDMI, 1 x Display port 4 x USB 3.0 2 x LAN
Audio	Mic-in, Line-out
HDD	2 x SATA
Expansion	1 x Mini PCIe
Operating Temperature	-5 ~ 60°C (23 ~ 140°F)
Storage Temperature	-20 ~ 80°C (-68 ~ 176°F)
Operating Humidity	0% ~ 95% Relative Humidity, Non-condensing
Size	170mm x 170mm



# Boards & Power

Embedded main board, is wide range used in, industrial automation, telecommunication equipment, medical equipments, etc.

## CB0M04-A20

RISC MB

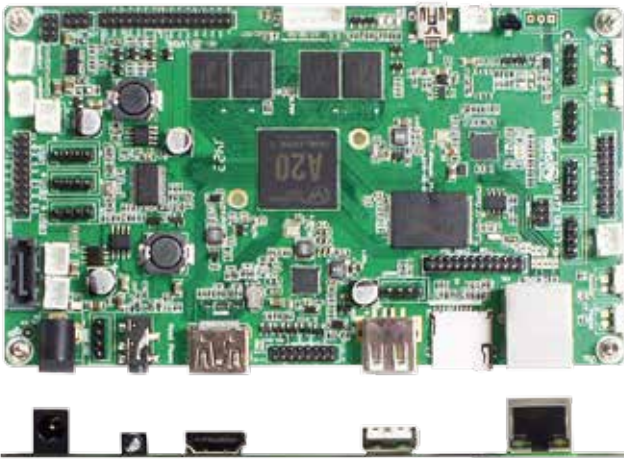

CPU	ARM® Cortex™ -A7 Dual-Core
BIOS	N / A
Graphic Chipset	N / A
System Memory	Memory 1GB DDR3 @960M
I / O Ports	1 x HDMI 1 x USB 2.0 1 x mini-SD slot 1 x LAN
Audio	1 x Audio out
HDD	1 x SATA
Expansion	1 x Mini PCIe
Operating Temperature	-5 ~ 60°C (23 ~ 140°F)
Storage Temperature	-20 ~ 80°C (-68 ~ 176°F)
Operating Humidity	0% ~ 95% Relative Humidity, Non-condensing
Size	153mm x 89mm

## CB0P01-S5P6818

RISC MB



CPU	ARM Cortex™ A 53 Octa Core
BIOS	N / A
Graphic Chipset	N / A
Main Memory	2GB DDR3 @960M
I / O Ports	1 x HDMI 2 x USB 2.0 1 x Micro SD 1 x RJ45 1 x Audio
Card reader	SD card reader
Operating Temperature	-10 ~ 50°C (5 ~ 85°F)
Storage Temperature	-20 ~ 80°C (-68 ~ 176°F)
Operating Humidity	0% ~ 95% Relative Humidity, Non-condensing
Size	153mm x 89mm



## PDDI001-W12-80

## Power Module

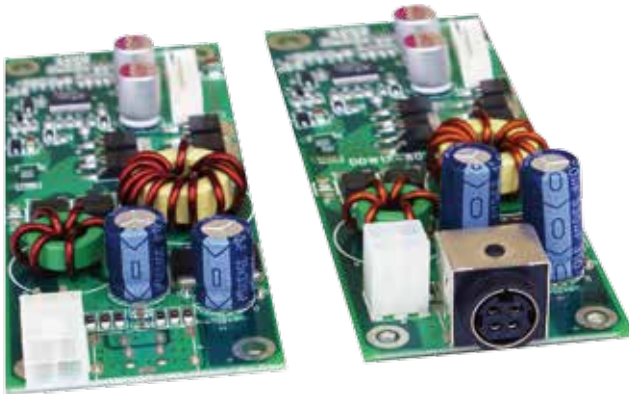

Input Voltage	9V to 36V DC
Output Voltage	12V DC
Load Range	6.6A
Power Consumption	80W
Ripple And Noise	Less than 120mV
Line Regulation	Less than 1% at rated load with 9V~36V input
Load Regulation	Less than $\pm 5\%$
Efficiency	> 80% at full load
Altitude	0 to 10000ft
Protection	OCP protection > 8A
Operating Temp.	0° ~ 50° C
Storage Temp.	- 20° ~ 70° C
Humidity	10 ~ 90% non-condensing
Dimension	120x45x17

## PDDI002-W12-80-ISO

## Power Module



Efficiency	See Table
Isolation Voltage	1500 VDC min.
Switch Frequency	330KHz
Isolation Resistance	108 Ohms min.
Over temperature shutdown point	120°C typ.
Operation Temperature	-40°C to +120°C
Storage Temperature Range	-55°C to +125°C
EMI/RFI Conducted	EN55022 Level A/B
Dimensions	2.40*2.28*0.45 inches (60.96*57.91*11.50 mm)
Weight	80g

## PDDI003-24AX-120

## Power Module

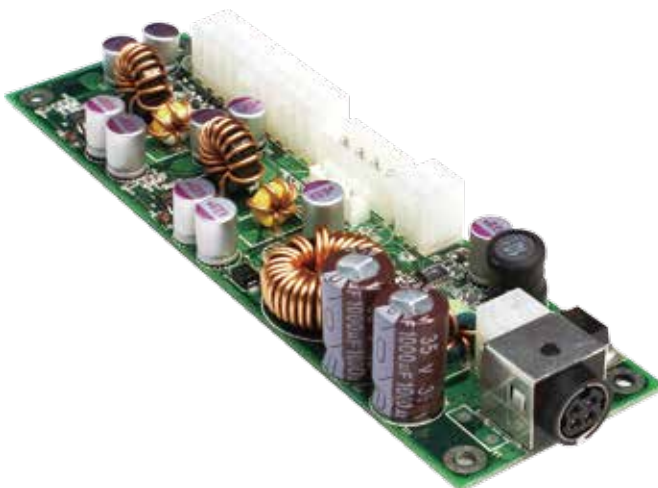

Input Voltage	24V DC
Load Range	5V : 6A, 12V : 5A, -12V : 0.5A, 3.3V : 5A, 5Vsb : 1A
Ripple And Noise	5V : Less than 100mV, 3.3V : Less than 66mV 5Vsb : 100mV, 12V : 120mV, -12V : 200mV
Line Regulation	Less than $\pm 2.5\%$ at rated load with $\pm 10\%$ change in input voltage
Load Regulation	5V : Less than $\pm 5\%$ +12V : Less than $\pm 5\%$ -12V $\pm 5\%$ +3.3V Less than $\pm 5\%$
Efficiency	88%
Altitude	0 to 10000ft
Operating Temp.	0° ~ 50° C
Storage Temp.	-20° ~ 70° C
Humidity	10 ~ 90% non-condensing
Dimension	154x45x25.6(mm)



# Embedded System



**IP67 SEALED**  
**EMBEDDED BOX PC**

Winsonic offer a series of high performance and durable Embedded Box PC system for industrial applications. The durable PC system is rugged with wide expansion capability and reliable in any critical environments, such as Digital Signage, Automation, Marine, Vehicle, Gaming, Banking, Medical, Kiosk and so on.



Reliable Heatsink



Quick & Easy DIY replaceable



Option: Wifi / Bluetooth / 3G



Transportation BOX PC



Digital Signage



POS



Gaming

## BC01-0M05 - Fanless



Construction	Aluminum extrusion
CPU	Intel® Celeron J1900
System Memory	2 x DDR3 1333/1600MHz DIMM Slot
Chipset	Intel®J1900 Processor
OS Support	Windows XP, 7, CE6.0, Linux
System I/O Outlet	1 x VGA, 1 x HDMI, 2 x USB, 2 x LAN Audio Line-Out

## BC05-0J07 - Fanless



Construction	Aluminum extrusion and heavy-duty steel
CPU	Intel® Celeron J1900 Processor
System Memory	2 x DDR3 1333 DIMM Slot; Max up to 8GB
Chipset	Intel® Atom BayTrail
OS Support	Windows XP, 7, CE6.0, Linux
System I/O Outlet	1 x VGA 3 x RS2324 x USB2 x LAN PS2 / Mic-in, Line-out

## BC05-0J08 - Fanless



Construction	Aluminum extrusion
CPU	Intel® i3/i5/i7/Celeron Processor
System Memory	2 x DDR3 1333/1600Hz DIMM Slot
Chipset	Intel® H61
OS Support	Windows XP, 7, CE6.0, Linux
System I/O Outlet	1 x VGA, 1 x HDMI, 2 x RJ45 (Gigabit Lan) 6 x USB, 1 x PS2 combo, Mic-in, Line-out

## BC09 - S5P6818



Construction	Aluminum extrusion
CPU	ARM® Mail400MP4
System Memory	One 2GB DDR3 @960M
Chipset	ARM® Cortex™ A 53 Octa Core
OS Support	Android 5.1 Linux+QT2.2 & Ubuntu12.04
System I/O Outlet	1 x HDMI, 1 x RJ45 (Gigabit Lan) 2 x USB, 1 x Audio

## BC10-0J07 - IP67



Construction	Aluminum extrusion
CPU	Intel® Celeron J1900
System Memory	2 x DDR3 1333 DIMM Slot
Chipset	Intel® BayTrail
OS Support	Windows XP, 7, CE6.0, Linux
System I/O Outlet	1 x VGA, 1 x RS232, 2 x USB 2.0, 1 x LAN

## BC0A - Braswell



Construction	Aluminum extrusion
CPU	Intel Celeron Processor N3160 CPU onboard
System Memory	4G DRAM / 64G eMMC
Chipset	Intel Atom Braswell
OS Support	Windows 7 / 8 /10
System I/O Outlet	2 x USB 3.0, 1 x LAN 2 x USB 2.0, 1 x COM 2 x HDMI



# Digital Signage

Sound and Image are the most popular and attractive communications. Digital Signage is some kind of entertainment and information broadcast system. Digital Signage use digital media displays to broadcast information and advertising to viewers that you see in lobbies, along roadsides, at stations and airports. On the other hand, the broadcasters use management software to manage the schedule of programs. Use the software to manage the programs to broadcast a specific time and area of display.

## Media Player

Winsonic provides networkable digital signage system with compact size and reliable media player. Digital Signage Solutions provide reliable Network Media Players and Management Software. Media Player provides Linux with low cost and reliable fanless system. It supports 1080P and is a multimedia, it suitable for variety signage application such as Hotel, Education, Museum, and Transportation.

Standalone Digital Signage	Networking Digital Signage	Functions
YES	YES	Android 4.2.2
Contents Support		
YES	YES	Performance: 1080P (one of multi-zone) / 720P / 480P
YES	YES	Video: 3gp / flv / mov / webm / WAV / AVI / DIVX & MPEG 1/2/4"
YES	YES	Image: jpeg / png / bmp / tiff
Playlist Management		
YES	YES	Entire disk looping playback ( In order to content's alphabetical)
YES	YES	Power Resume: Continue play the content from break point after power recovery.
YES	YES	Scheduling by weekly, segments to play specified contents
YES	YES	Webpage Browsing
YES	YES	Sliding Photo
YES	YES	Scrolling Text
YES	NO	Device Grouping
YES	YES	Adjustable Multi-Zone
Signal Output		
YES	YES	HDMI
YES	YES	LVDS (For all in one system)
Hardware Setting		
YES	YES	Option: Motion Sensor / Touch
YES	YES	Rotate (Portrait / Landscap)
YES	NO	Auto search plug and play local network connection
Content Update		
YES	YES	USB update
YES	YES	Remote update



## Taxi Digital Signage

There is a wide variety of venues use digital signage today. In fact, it is difficult to think of a place that does not benefit from digital signage. On our application cases, you can find examples of customers using our digital signage CMS software as a service. Find your relevant business sectors in the options below and see how our digital signage platform can help your business: in retail stores, academic institutions, transits, Shopping malls, corporations, entertainments and much more.

Digital signage with 3G remote content update and CMS, can help managers to set up and manage their signs easily in the store Or from the corporate office to any of other stores. Different message can be targeted to different locations and easily update at anytime from anywhere.

Transit:

Public transportation is one of the fastest growing sectors taking advantage of digital signage. More and more, ads and information are being displayed digitally on buses, trains, shuttles, and in taxis. Digital signage is used in buses and train stations in major urban centers around the world to provide directions, updated information and promotions by using the remote content update application.

### Key Pad



Interactive quick buttons LCD advertising signage becomes more popular.

### Live TV



Easy to feed live-TV into your signage layout.

### Touch



Integrate touch screen for digital signage industry. Interactive displays are becoming more popular.

### Motion Sensor



Inbuilt motion sensor LCD advertising signage can be switch off after sensing no movement in time. You don't need turn on and off all the time.

### SMIL / HTML 5



The product leverage SMIL & HTML5 for designer to create online Signage.

### Wi-Fi / 3G



Retrieve data from Internet.



# Marine

Winsonic incorporates many unique features to add more functionality. These units are suitable for a wide variety of military and commercial shipping or avionics applications. Available in various sizes from 8" to 24" for Marine Chassis and Marine Flush Mount enclosure.

Our Marine grade LCD Displays with aluminum enclosure is suited for the harshest environment out there. With IP65 Front water resistant and IP54 Back, not only it's water resistant, dust proof and it's also anti-corrosion.

## MFM (Flush Mount)

Marine grade monitor with flush mount solution



Available Size

4:3	6.5" 8.4" 9.7" 10.4" 12.1"		16:9	12.1" 15.6" 17" 18.5" 19"
	15" 17" 19" 21.3" 23.1"			21.5" 22" 24"

## MSCH (Stainless Chassis)

Stainless housing without brilliant outlook



Available Size

4:3	6.5" 8.4" 9.7" 10.4" 12.1"		16:9	12.1" 15.6" 17" 18.5" 19"
	15" 17" 19" 21.3" 23.1"			21.5" 22" 24"

## MCH (Marine Grade Chassis)

Marine grade metal housing without powder coating



Available Size

4:3	6.5" 8.4" 9.7" 10.4" 12.1"		16:9	12.1" 15.6" 17" 18.5" 19"
	15" 17" 19" 21.3" 23.1"			21.5" 22" 24"

## MFCH (Full IP66, Stainless)

Stainless IP66 housing fit for harsh environment



Available Size

4:3	6.5" 8.4" 9.7" 10.4" 12.1"		16:9	12.1" 15.6" 17" 18.5" 19"
	15" 17" 19" 21.3" 23.1"			21.5" 22" 24"

# ECDIS

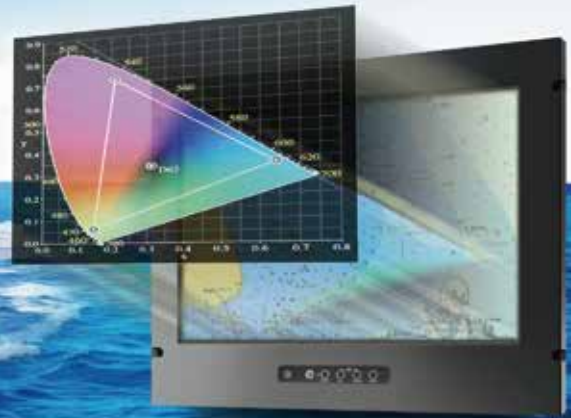

## ECDIS

ECDIS Display calibration is a very important aspect of Marine. ECDIS represents one of the most rigorous applications of display technology. It is important that monitors match the colour characteristics specified in relevant standards.

### Feature

- Wide dimming adjusting through PWM control
- 10mm Aluminum, Flush Mount front Bezel
- With IP65 front and IP54 rear cabinet
- Housing with powder coating design Anti Salt
- Anti Corrosion
- Protected glass
- Isolated 9~36VDC wide voltage input
- Anti-Shock and Vibration enhanced
- Removable Stand
- Wide Viewing angle Adjustable

### Optional Mounting Solution

Roof Mount

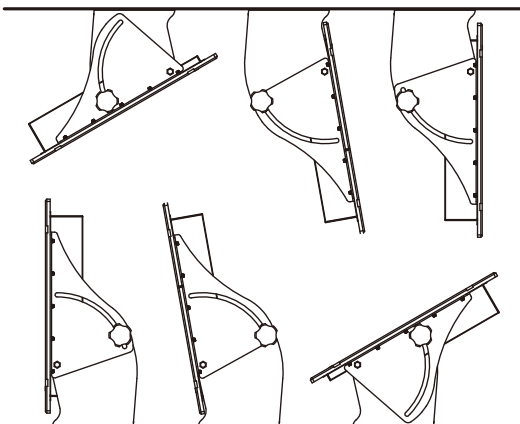

Stand Mount

### Wide Temperature Solution

For certain extreme applications like military. Marine or some outdoor applications, a wide range temperature solution is required to survive the environment. Those applications exposed to direct sunlight can lead the surface of the LCD display as much high as +55°C to +60°C, and even worse with temperature fluctuations. The water-proof requirement and heat generated by the LCD panel and the electronics in combination with heat caused by solar energy make the outdoor application a extreme harsh environment for the LCD Monitor / PC. Winsonic provides rugged LCD displays / PC solution for those extreme environments. The wide temperature requirement can range from -30°C to +60°C or even more extreme.





# HMI

The ability to visualize and present data to operators in an intuitive and attractive way is a vital competitive factor in the design of any automation system. We offer a complete range of HMI products, developed with functionality and ease-of-use in mind and broad application areas includes HMI software, operator panels and industrial PCs.

## HM-PPM070B



Panel Size 7"  
Resolution 800 x 480  
Platform ARM® Cortex™ A 53  
Storage 16GB internal eMMC  
RAM 2GB DDR3  
Touch 5 Wires Resistive Touch

## HM-ZPPM101A



Panel Size 10.1"  
Resolution 1280 x 800  
Platform Intel® Atom Braswell  
Storage 64GB eMMC  
RAM 4G  
Touch Projected Capacitive Touch

## HM-PPM104B



Panel Size 10.4"  
Resolution 1024 x 768  
Platform ARM® Cortex™ A 53  
Storage 16GB internal eMMC  
RAM 2GB DDR3  
Touch 5 Wires Resistive Touch

## HM-ZPPM104B



Panel Size 10.4"  
Resolution 1024 x 768  
Platform Intel® Atom Braswell  
Storage 64GB eMMC  
RAM 4G  
Touch Projected Capacitive Touch

## HM-PPM150B



Panel Size 15"  
Resolution 1024 x 768  
Platform ARM® Cortex™ A 53  
Storage 16GB internal eMMC  
RAM 2GB DDR3  
Touch 5 Wires Resistive Touch

## HM-ZPPM150B



Panel Size 15"  
Resolution 1024 x 768  
Platform Intel® Atom Braswell  
Storage 64GB eMMC  
RAM 4G  
Touch Projected Capacitive Touch

## Features - ARM

- Modularize mechanical design provides flexible product configuration and easy maintenance
- Build-in touch screen for interactive application
- ARM® Cortex™ A 53 Octa Core
- One 2GB DDR3 @960M Onboard 16GB internal eMMC
- Complete custom design/solution for OEM customers
- 1 x HDMI, 2 x USB, 1 x micro-SD slot, 1 x LAN, 1 x RS232/422/485
- Linux+QT2.2 / Ubuntu12.04 / Android 5.1

## Features - Braswell

- Modularize mechanical design provides flexible product configuration and easy maintenance
- Build-in touch screen for interactive application
- Intel®Atom Braswell
- Single Channel DDR3L 1333 MHz SDRAM
- Complete custom design/solution for OEM customers
- 2 x HDMI, 1 x COM, 2 x USB, 2 x USB 3.0, 1 x LAN
- Win 7 / 8 / 10





# POS All in One POS

Ultimate retail's point of sale solution with touch screen provides reliable performance and powerful functions.

- The latest Intel Core i3 /i5 /i7, Atom D525 and ARM solution provide wide range of POS Terminal feature.
- OS supports: Windows XP/7/8 or Androids 4.0
- Touch Sensor Solutions: PCT (RS232 or USB) & RT (RS232 or USB)

support Camera & Light Sensor



Support Stripe Card Reader (MSR)



Support Rich I/O Ports



Quick & Easy replaceable DIY HDD



Tilt Adjustable



Cables & Adapter management



## POS Computer

Cost and effective solution embedded POS Computer provides fanless and fashionable fan box pc. Compact size with rich I/O ports for the variety and performance retail demands.



## Touch Monitor

LCD Touchscreen monitor has the exceptional screen performance with remarkable contrast ratio and brightness quality.

- Touch screen performs the highest accuracy, reliability, long product life in the market today. Options Touch Sensors: PCT(RS232 or USB) & RT(RS232 or USB)
- The Stands are provides wide angle adjustable tilt.
- Available size of Monitor from 10.4" ~ 19" or customize larger.

## Accessories

Winsonic provides the variety accessory for one-stop service with barcode scanner, thermal printer, cash drawer, and customer display...



Cash Drawer

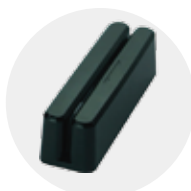

MSR



Network



Thermal Printer



Barcode Scanner



Customer Display



# Industrial Automation

As a professional and experienced manufacturer, Winsonic supplies full range of high-performance and quality Industrial Automation products to meet customers' variety of applications.

## Industrial Automation System

Industrial Automation System is a computer-controlled systems that monitor and control industrial processes. It is normally a system of complexes, spread out over large areas. All devices are connected through Internet or fieldbus Network. The SCADA/HMI is the interface allow operator to monitor or give control instructions. The PAC/PLC is working as the host to perform the control instructions through a RTU or Remote I/O modules. Sensor and other control devices, like actuator, electric motor, switch, valve and contractor, are deployed to perform the control functions.

## Industrial Device Requirement

Winsonic Industrial Automation product includes HMI, PAC, Box Computer, Fieldbus Data I/O, Industrial Data Communication, Wireless Solution. You can always find a well fit Industrial Automation product for your application, either in a commercial environment or rugged industrial environment.

## Modbus

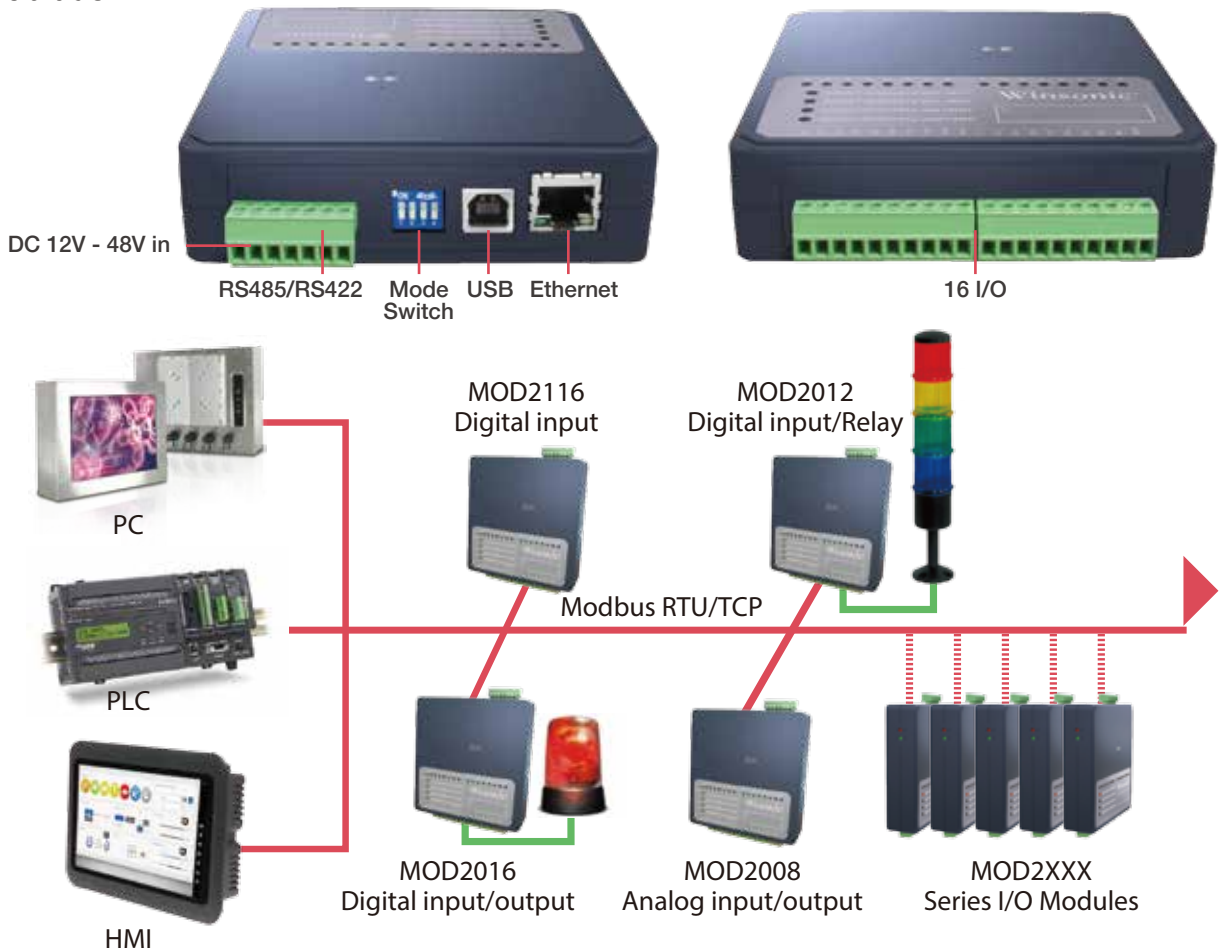

# Industrial Device Requirement

Winsonic Industrial Automation product includes HMI, PAC, Box Computer, Fieldbus Data I/O, Industrial Data Communication, Wireless Solution. You can always find a well fit Industrial Automation product for your application, either in a commercial environment or rugged industrial environment.

## BOX PC



AT-BC0C-CB0P01  
Android 5.1 Linux+QT2.2 & Ubuntu12.04

### Features

- Aluminum extrusion
- ARM® Mail400MP4
- One 2GB DDR3 @960M
- ARM® Cortex™ A 53 Octa Core
- Android 5.1 Linux+QT2.2 & Ubuntu12.04
- 1 x HDMI, 1 x RJ45 (Gigabit Lan)
- 2 x USB, 1 x Audio

## AHMI-2104



2x LAN, 2xUSB(1x OTG,1Host),  
1x RS232/485/422, 1x MicroSD,  
1x HDMI

### Features

- 15"/12.1"/10.1"/8.4"/W7" LCD
- One 2GB DDR3 @960M
- 16GB internal eMMC
- Resolution: 800 x 480 ~ 1024 x 768
- Resistive Touch Panel
- ARM® Cortex™ A 53 Octa Core
- Android 5.1 Linux+QT2.2 & Ubuntu12.04
- Operating Temperature: -10 ~ +60°C

## Modbus I/O Module



DAU01-MOD2008-4AI+4AO  
DAU01-MOD2012-8DI+4RLY  
DAU01-MOD2016-8DI+8DO  
DAU01-MOD2116-16DI  
DAU01-MOD2216-16DO  
DAU01-MOD2016-8DI+6DO+2PWM

### Features

- Support for both Modbus RTU, TCP/UDP protocol
- 3 ways communication with RS485/R422, Ethernet and USB
- Built-in web server Web-based Remote I/O
- Remote and local monitoring
- Flexible user-defined Modbus address
- Multi-channel data acquisition module
- Power input DC 12V - 48V

## Ethercat I/O Modules



DAU01-ECAT2xxx series  
DAU01-ECAT2016-8DI+8DO  
DAU01-ECAT2012-8DI+4RLY  
DAU01-ECAT2116-16DI  
DAU01-ECAT2216-16DO

### Features

- Powerful MCU handles efficient network traffic
- 2 x RJ-45 bus interface
- Distance between Stations up to 100 m (100BASE-TX)
- Support daisy chain connection
- Built-In digital I/O or RLY
- RoHS compliant
- ESD Protection 4 KV Contact for each channel
- Power Input DC 12V- 48V

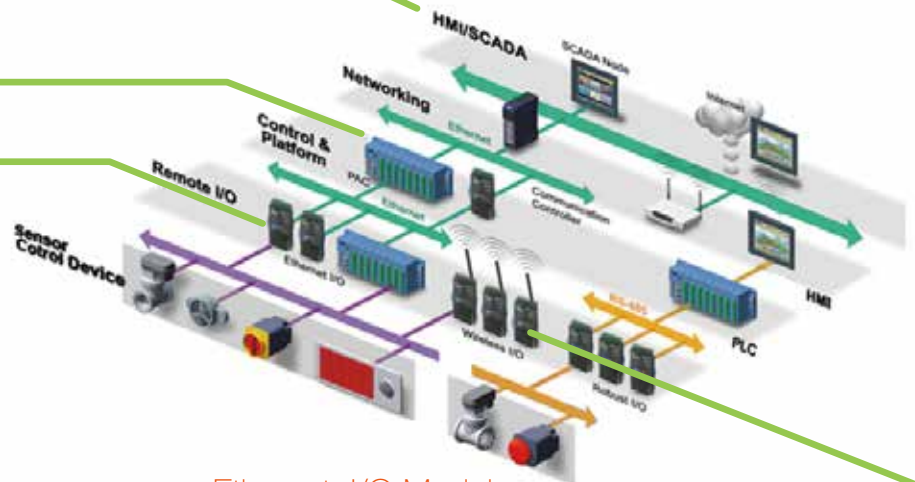



# Wireless

Wi-Fi / 3G / Bluetooth / GPS / RFID wireless modules can be embedded in devices to enable them for work in the Internet of Things. Such as motion sensors, cameras, microphones and other pc devices Home automation systems already implement the concept for things like light bulbs, plus other devices like TV remote control and wireless speakers that each represents early examples of IoT.

## Internet of Things: The number of things connected to a link.

### WiFi

WMW01-RTL8188



- IEEE 802.11 b/g/n Wireless Local Area Networks
- 50 Ohm RF connectors for external 2.4G antennas.
- Win7, Vista, XP WHQL certified.
- RoHS compliant.

### Wireless Combo

WM201-RTL8188CE

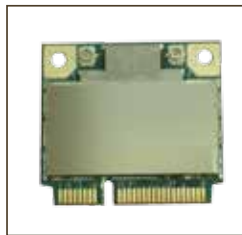

- WM201-RTL8188CE Photo
- PCIe v.1.2 HMC (Half MiniCard H2 Type) specification.
- Bluetooth spec. v.2.1 plus EDR (Enhanced Data Rate) and 3.0+HS (High Speed) compliant.
- WLAN 802.11n , 1x1.
- I/O: PCIe for WLAN, and USB bus interface for BT.

### Bluetooth

WMB01-CSR8510

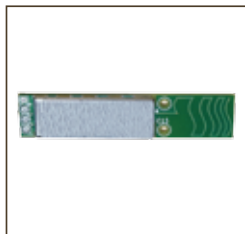

- Bluetooth spec. v.2.1/3.0 compliant plus EDR (Enhanced Data Rate).
- HCI USB with USB2.0 full-speed compliant interface.
- Powered by +3.3V. RoHS compliant.

### 3G

WMC01-ZU200



- HSUPA 5.76 Mb/s, HSDPA 7.2 Mb/s
- Compatible Mini PCIE spec. standard interface revision 1.0 & 1.2
- Easy migration from 2G/2.75G modules (SW & HW)
- Module with Integrated SIM holder

### RFID

WMR01

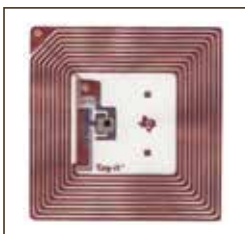

- No line of sight required for reading
- Multiple items can be read with a single scan
- Each tag can carry a lot of data (read/write)
- Individual items identified and not just the category

### GPS

WMG01-U-Blox6



- U-Blox 6 position engine with over 2 million effective correlators featuring < 1s acquisition, -147dBm cold start acquisition sensitivity and 5Hz update rate.
- Water-resistance.
- USB Interface

## Smart Cities

- Smart parking: Monitoring of parking spaces availability in the city.
- Traffic congestion: Monitoring of vehicles and pedestrian levels to optimize driving and walking routes.
- Smart lightning: Intelligent and weather adaptive lighting in street lights.
- Intelligent transportation systems: Smart Roads and Intelligent Highways with warning messages and diversions according to climate conditions and unexpected events like accidents or traffic jams.

## Security and Emergencies

- Perimeter access control: Access control to restricted areas and detection of people in non-authorized areas.
- Liquid presence: Liquid detection in data centers, warehouses and sensitive building grounds to prevent break downs and corrosion.
- Radiation levels: Distributed measurement of radiation levels in nuclear power stations surroundings to generate leakage alerts.
- Explosive and hazardous gases: Detection of gas levels and leakages in industrial environments, surroundings of chemical factories and inside mines.

## Industrial Control

- M2M applications: Machine auto-diagnosis and assets control.
- Indoor air quality: Monitoring of toxic gas and oxygen levels inside chemical plants to ensure workers and goods safety.
- Temperature monitoring: Control of temperature inside industrial and medical fridges with sensitive merchandise.
- Ozone presence: Monitoring of ozone levels during the drying meat process in food factories.
- Indoor location: Asset indoor location by using active (ZigBee) and passive tags (RFID/NFC).
- Vehicle auto-diagnosis: Information collection from CanBus to send real time alarms to emergencies or provide advice to drivers.

## eHealth

- Fall detection: Assistance for elderly or disabled people living independent.
- Medical fridges: Control of conditions inside freezers storing vaccines, medicines and organic elements.
- Sportsmen care: Vital signs monitoring in high performance centers and fields.
- Patients surveillance: Monitoring of conditions of patients inside hospitals and in old people's home.
- Ultraviolet radiation: Measurement of UV sun rays to warn people not to be exposed in certain hours.



**Bus Wireless**



**Mall Wireless**



**Station Wireless**



# Display Wall

The display wall is designed to offer the ability to combine multiple LCD screens into one giant resolution screen. It is perfect for digital signage, Google earth, flight simulators, advertising, powerpoint presentations, art, live shows, hi-res images, traffic or security control room and much more applications. Screen Size: 42", 46", 55".

- Narrow Border design
- Easy installation construction
- Friendly setting through OSD Menu
- Landscape: 3x3, 3x2, 3x1, 2x2, 4x2, 4x1, 1x4, 1x3
- Portrait: 3x1, 4x1
- Stand Type: 3x3, 3x2, 2x2

## Specifications

Size	Model Number	Resolution	Brightness	Input Ports	Viewing Angle	Display Wall Setting
<b>Landscape</b>						
42"	DWF4201-33	5760(H)x3240(V)	500cd/m <sup>2</sup>	VGA+DVI	H.178° (-89°~89°), V. 178°(-89°~ 89°)	By OSD
42"	DWF4201-32	5760(H)x2160(V)	500cd/m <sup>2</sup>	VGA+DVI	H.178° (-89°~89°), V. 178°(-89°~ 89°)	By OSD
42"	DWF4201-31	5760(H)x1080(V)	500cd/m <sup>2</sup>	VGA+DVI	H.178° (-89°~89°), V. 178°(-89°~ 89°)	By OSD
42"	DWF4201-22	3840(H)x2160(V)	500cd/m <sup>2</sup>	VGA+DVI	H.178° (-89°~89°), V. 178°(-89°~ 89°)	By OSD
42"	DWF4201-42	7680(H)x2160(V)	500cd/m <sup>2</sup>	VGA+DVI	H.178° (-89°~89°), V. 178°(-89°~ 89°)	By OSD
42"	DWF4201-41	7680(H)x1080(V)	500cd/m <sup>2</sup>	VGA+DVI	H.178° (-89°~89°), V. 178°(-89°~ 89°)	By OSD
42"	DWF4201-14	1920(H)x4320(V)	500cd/m <sup>2</sup>	VGA+DVI	H.178° (-89°~89°), V. 178°(-89°~ 89°)	By OSD
42"	DWF4201-13	1920(H)x3240(V)	500cd/m <sup>2</sup>	VGA+DVI	H.178° (-89°~89°), V. 178°(-89°~ 89°)	By OSD
<b>Portrait</b>						
42"	DWF4201-31P	3240(H)x1920(V)	500cd/m <sup>2</sup>	VGA+DVI	H.178° (-89°~89°), V. 178°(-89°~ 89°)	By OSD
42"	DWF4201-41P	4320(H)x1920(V)	500cd/m <sup>2</sup>	VGA+DVI	H.178° (-89°~89°), V. 178°(-89°~ 89°)	By OSD

## Monitor Arrangement

3x3 Landscape

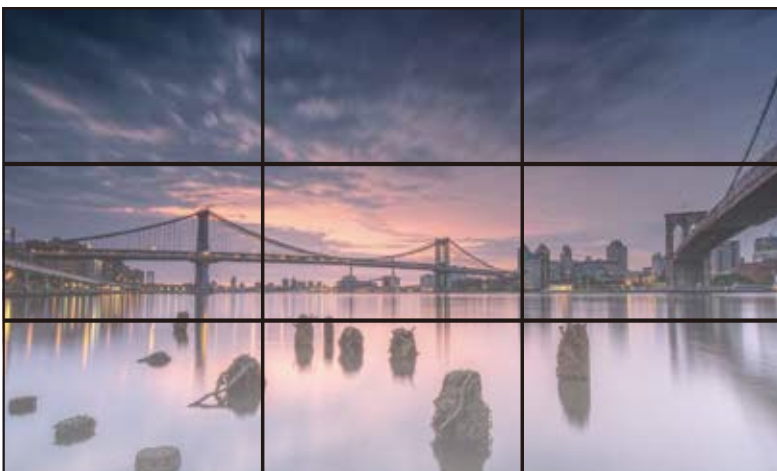

3x3 Portrait

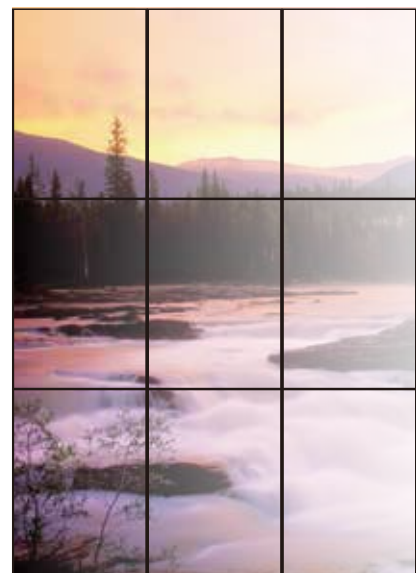

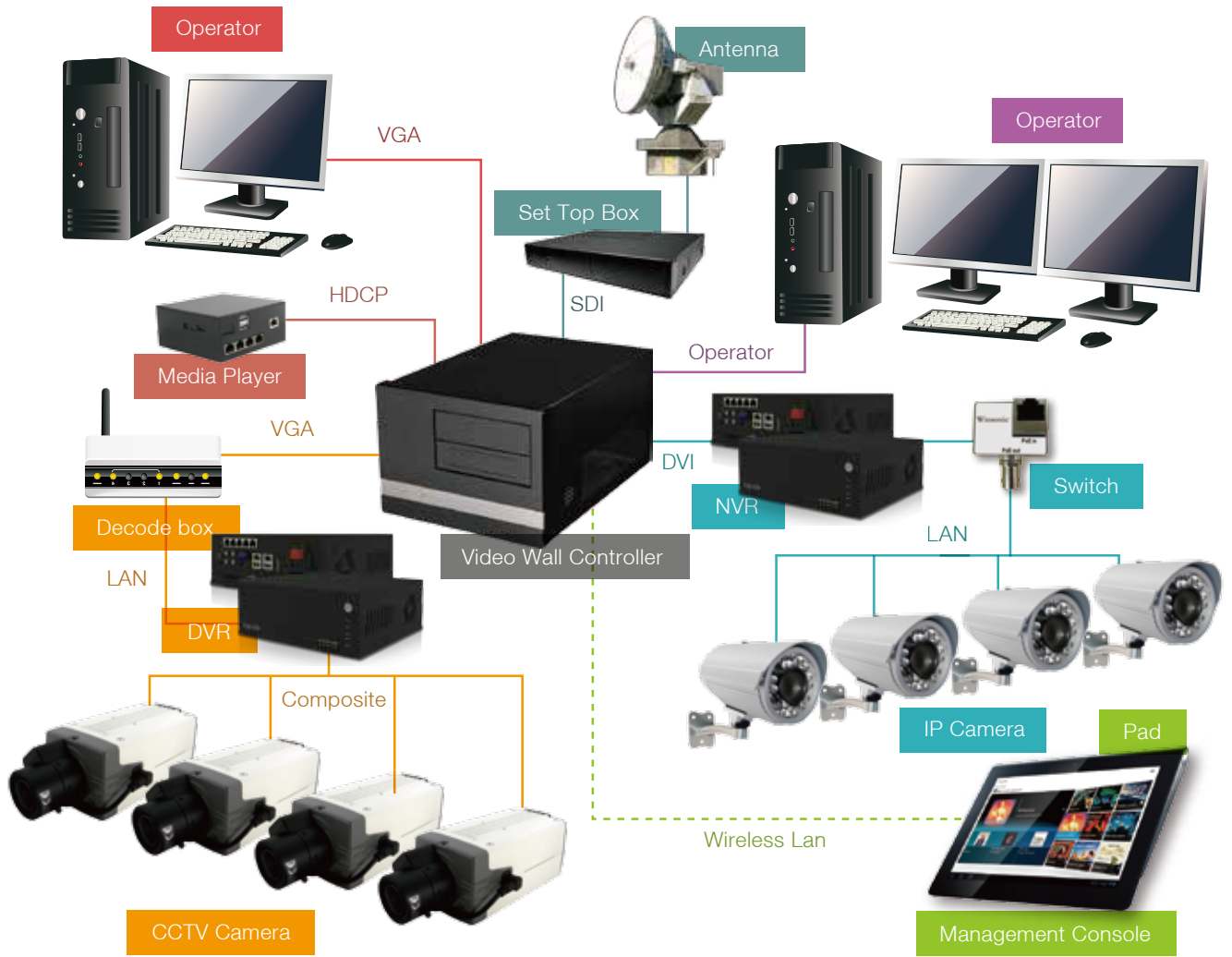

3x3 Landscape with stand

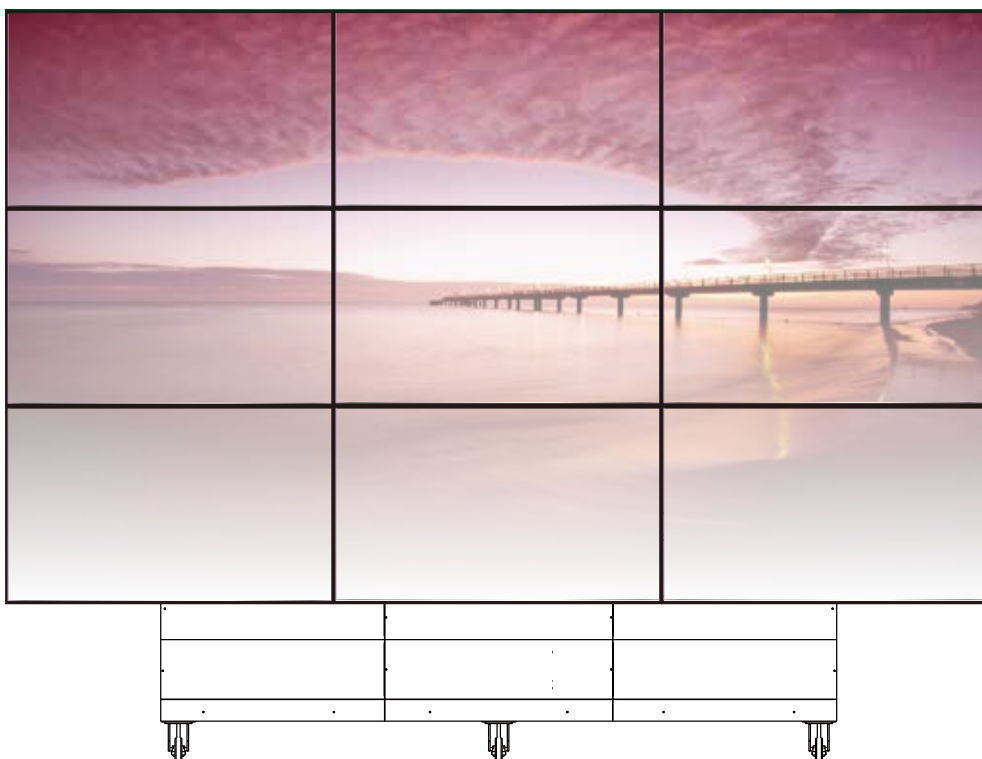



# Vehicle

Functions like 3G, GPS, Wifi and optional Bluetooth are available. At only 35W processor TDP, it delivers a very reliable, stable, fanless solution for vehicle application.

The Vehicle product series, an innovative series of in-vehicle display / computer, is designed for in-vehicle operation within trucks, buses, and trains.



## Intelligent Automotive / DC-DC PC Power Supply

Vehicle product line equipped with an intelligent, high power, vehicle DC-DC PC power supply designed for Vehicle pc or battery powered applications. Designed to provide power and to control the ON/OFF switch of a motherboard based on ignition status, Vehicle computer system is a wide input 9 to 36V DC for car / battery and 110~125V DC for Train / MRT, power supply capable of surviving tough car engine cranks (down to 9V) as well as transient over-voltage situations. Just connect it to your car / boat / RV / solar battery and power up vehicle pc.

## Vehicle Computer

Vehicle computer series is a high performance, Fanless based Vehicle Computer. It is newest series of in-vehicle computer, is designed for in-vehicle operation within trucks, buses, trains and taxi. It design with multitude of I/O interfaces which enable connectivity to various in-vehicle features. Vehicle computer is built the latest low power high performance 3rd Generation Core i7/i5/i3 processor, up to 8GB of system memory, four optional COM ports (3xRS-232 / 1 x RS-485).







**Vehicle Driver Display**

**Vehicle Passenger Display**



**Features**

- Rugged construction ensures exceptional stability
- LCD meets sunlight readability for navigation and transportation systems
- Multiple mounting options
- Technical support for hardware screens, monitors, controllers, peripherals including troubleshooting procedures and general system issues
- Customer service and sales support help with product selection, order management, and warranty status

**Features**

In recent years, information display is becoming more common in bus transport and is considered as an effective tool to manage passengers flow. Not only crucial information can be delivered to passengers in real-time via digital signage. The passengers can get the bus arrive time through the digital media display in the bus stops. The passengers can get more life information and advertisement during the waiting time.

**Shock Test Method**

Test method : Reference to MIL-STD-810F, Notice 3, 2003, Method 516.5 Testing Procedures I, Category 20-Ground vehicles-ground mobile. Table 514.5C-VII, Figure 514.5C-3 (Composite wheel vehicle vibration exposures)  
 Sample Condition: Operating  
 Wave form: Random  
 Frequency: 5~500 Hz  
 Impact acceleration: 1.62 & 2.05 & 2.20 grms  
 Duration: 1 hour/axis





# Ethernet Switch

Winsonic provides a wide range of industrial-grade Ethernet switches reliability, network redundancy, seamless integrated security, and offer plug and play. Power Over Ethernet Switches offer 60Watt PSD. Winsonic provides managed switch, unmanaged switch, Gigabit Ethernet switch, PoE switch, all products are compliance IEC 61850, EN50155, and rackmount Ethernet switch to provide users.

## Modbus Cellular Gateway for Industrial Automation

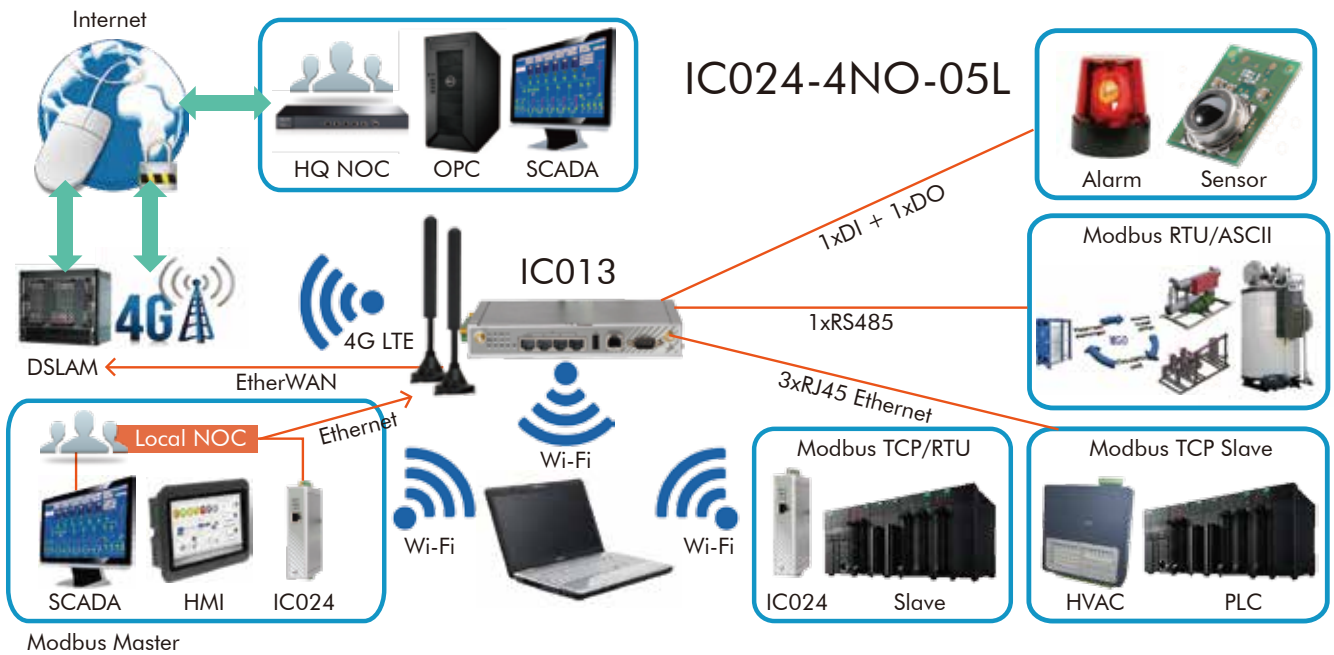

# Industrial Ethernet Switch

## Rackmount Ethernet Switch

### Managed

#### IC030-2840-M-R

Rack Mount Front Access,  
10-Port Gigabit  
(6 GbE + 2 SFP + 2 GbE/SFP COMBO)



#### IC016-2840-M-R

Rack Mount Rear Access,  
10-Port Gigabit  
(6 GbE + 2 SFP + 2 GbE/SFP COMBO)



#### IC017-2840-M-R

24 Gigabit Copper ports plus  
4 SFP ports 100FX or 1000BaseF



#### IC018-2840-M-R

24 Gigabit Copper ports plus  
4 SFP ports 100FX or 1000BaseF



---

### Unmanaged

#### IC013-2620-U-R

Rack Mount Front Access,  
24 Gigabit Copper ports  
plus 2 ports 100FX or 1000BaseF



#### IC014-2620-U-R

Rack Mount Rear Access,  
provide 24 Gigabit Copper ports  
plus 2 ports 100FX or 1000BaseF



# DIN-Rail Ethernet Switch

## Managed

### IC015-1040-M-D

Rack Mount Front Access,  
10-Port Gigabit  
(6 GbE + 2 SFP + 2 GbE/SFP COMBO)



### IC019-0800-M-D-2D

Provide 8 Gigabit Copper ports



### IC020-0820-M-D-2D

6 Gigabit Copper ports  
plus 2 SFP ports 100FX or 1000BaseF



### IC021-1000-M-D-2D

Provide 10 Gigabit Copper ports



### IC022-1020-M-D-2D

Provide 8 Gigabit Copper ports  
plus 2 SFP ports 100FX or 1000BaseF



### IC023-1040-M-D-2D

6 Gigabit Copper ports,  
4 SFP ports 100FX or 1000BaseF



### IC024-1240-M-D-2D

8 Gigabit Copper ports,  
4 SFP ports 100FX or 1000BaseF



### IC025-1440-M-D-2D

10 Gigabit Copper ports,  
4 SFP ports 100FX or 1000BaseF



# DIN-Rail Ethernet Switch

## Unmanaged

IC001-0300-U-D-2D

3 x 10/100BaseT(X) ports



IC002-0310-U-D-2D

2 x 10/100BaseT(X) ports plus 1x 100FX port



IC003-0500-U-D-2D

2 x 10/100BaseT(X) ports plus 1x 100FX port



IC004-0510-U-D-2D

4 x 10/100BaseT(X) ports plus 1x 100FX port



IC005-0800-U-D-2D

8 x 10/100BaseT(X) ports



IC006-0820-U-D-2D

6 x 10/100BaseT(X) ports plus 2 x 100Base SFP slots



IC007-0500-U-D-2D

5 Gigabit Copper ports



IC008-0510-U-D-2D

4 Gigabit Copper ports plus 1 100FX or 1000BaseF



IC011-0800-U-D-2D

8 Gigabit Copper ports



IC012-0820-U-D-2D

24 Gigabit Copper ports plus 2 ports 100FX or 1000BaseF



# Industrial PoE Switch

## Managed

### IC026-1248-M-D-2D

8 10/100/1000 Base TX PoE ports  
plus 4 100FX/1000BaseF SFP slots



### IC027-1448-M-D-2D

8 10/100/1000 BaseTX PoE ports,  
2 10/100/1000 BaseTX,  
plus 4 100FX/1000BaseF SFP slots



### IC028-0804-M-D-2D

8 10/100/1000 Base TX PoE ports  
plus 4 100FX/1000BaseF SFP slots



### IC029-0804-M-D-2D

4 or 8 10/100/1000 Base TX PoE ports  
plus 2 or 4 100FX/1000BaseF SFP slots



---

## Unmanaged

### IC031-0504-U-D-2D

Full Gigabit Ethernet ports



### IC032-0510-U-D-2D

Full Gigabit Ethernet ports



# Industrial Ethernet Gateways

## Industrial Cellular Gateways

IC014-5NO-04P

Industrial PoE Cellular GW with  
4 Gigabit PoE+ Ports



IC014-TCP-04P

Industrial PoE Cellular GW with  
4 Gigabit PoE+ Ports



IC015-TCP-04L

M2M Multi-Cellular Gateway



## Modbus TCP Gateway

IC015-TCP-01L

Modbus Cellular Gateway



IC024-4NO-05L

Modbus Cellular Gateway



# Outdoor Wireless Gateway

## Outdoor Wireless Gateway

IC013-WNO-01P

Outdoor Cellular Gateway





 **Logicbus**



GDL: +52 (33)-3854-5975  
+52 (33)-3823-4349  
USA: +1 (619) 616-7350



Av. Fray Antonio Alcalde 1822  
Miraflores, 44270  
Guadalajara, Jal.



[www.logicbus.com.mx](http://www.logicbus.com.mx)  
[tienda.logicbus.com.mx](http://tienda.logicbus.com.mx)

[soporte@logicbus.com](mailto:soporte@logicbus.com)

