

Omni Fleet: Your Complete Material Handling Suite

Better Performance, Better Value



The future is faster.
The future is stronger.
The future is smarter.

Nicolas Chee
Founder and CEO
ForwardX Robotics



Contents

Solutions

Fulfillment	4
Case Study: JD.com	6
Distribution	8
Case Study: DHL	10
Case Study: ITOCHU	12
Manufacturing	14
Case Study: TCL	16
Automotive	18
Case Study: SERES	20

Products

Matrix Automation Platform	22
Flex AMRs	24
Conveyor AMRs	30
Max AMRs	32
Lynx AMRs	36
Apex AMRs	38
f(x) Fleet Manager Software	40

About ForwardX	42
----------------	----



Fulfillment

Workflows

Piece Picking

Use Flex AMRs for batch picking or discrete order picking of small individual items.

Case Picking

Use Flex or Max AMRs for larger individual items or case loads of smaller items.

Pick and Pack

Use Flex or Max AMRs to pick and place items directly into packing containers and apply shipping labels on the fly.

Your Current Pain Points

Low Productivity

Rising ecommerce volume means more orders and pieces to pick. The traditional manual methods are slow, labor intensive, and restrictive.

High Labor Costs

Piece picking requires more space and more labor. Traditional operations spend more money to hire and retain workers, and this results in lower margins.

Low Efficiency

Wasted movement is wasted time and wasted money. Traditional operations are limited by low efficiency and need smart automation.

High Error Rate

Manual methods cause errors, and errors waste time and money. Errors also result in a poor customer experience, and error resolution is costly.



Industries



3PL



Omnichannel



Ecommerce

Results We Deliver

Productivity: 2x–3x UPH Increase

ForwardX solutions increase productivity through consolidated workflows that reduce wasted time and increase output. Double or even triple your pickers' units picked per hour by removing insignificant tasks.

Accuracy: Up to 99.9% Picking Accuracy

Instead of pick lists, f(x) organizes and distributes orders directly to employees. Use on-screen visual directions and onboard RFID scanning, so your workers can pick correctly the first time, every time.

Payback: ROI in Under 9 Months

ForwardX solutions deliver immediate results. See a marked improvement and financial gain in under 2 weeks, and get a guaranteed return on investment in less than 9 months.

Efficiency: 60% Reduction in Walking Time

AMRs handle material movements, allowing employees to focus on more important tasks. Reduce traveling, picking, and order reviewing time to achieve more in a shorter period.

Savings: 50% Reduction in Labor Costs

AMRs address recruitment and turnover issues by increasing productivity and worker satisfaction. Automate repetitive workflows and redistribute your work force to cut your fully burdened labor costs in half.

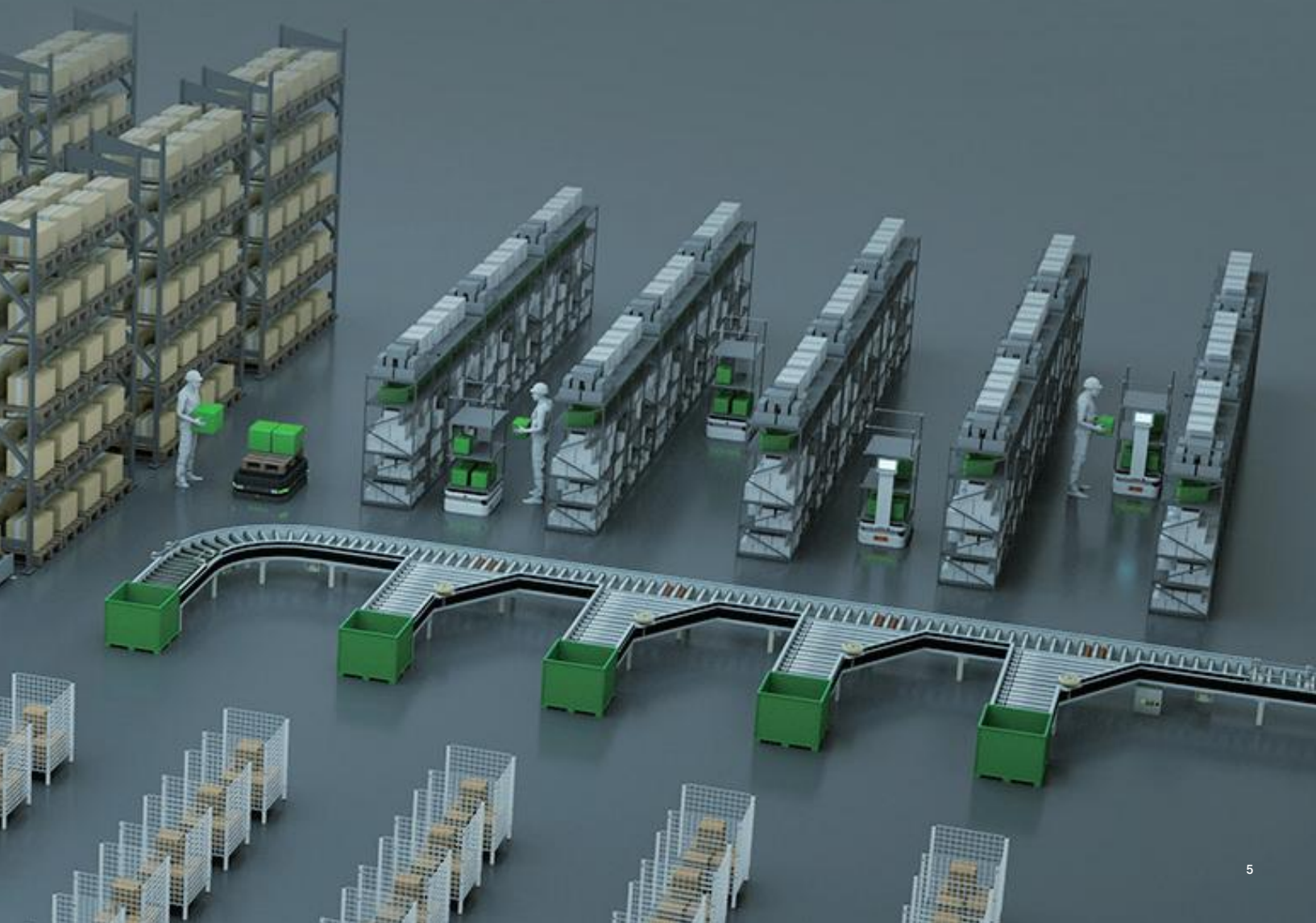

JD.com

JD.com chose a ForwardX Max solution for case picking workflows in both B2B retail store replenishment and B2C ecommerce fulfillment. The Max solution consists of Max 600 AMRs to increase picking efficiency and reduce high labor turnover, due to the physically demanding nature of case picking. After the flagship project, over 30 more projects of this nature have been deployed with JD Logistics.

Results

2.36x

Productivity Increase

~4,000

Daily Orders

>30

More Projects Deployed
Since Flagship Project



Distribution

Workflows

Piece Picking

Use Flex AMRs for batch picking or discrete order picking of small individual items.

Case Picking

Use Flex or Max AMRs for larger individual items or case loads of smaller items.

Pallet Picking

Use Max AMRs to pick direct to pallets.

Pick and Pack

Use Flex or Max AMRs to pick and place items directly into packing containers and apply shipping labels on the fly.

Your Current Pain Points

High Labor Intensity

Distribution environments can be harsh, and workflows can be physically draining. High labor intensity results in errors and worker turnover.

High Labor Costs

Labor intense work means high labor and recruitment costs. Traditional methods squeeze profit margins and are at the mercy of a growing labor shortage.

Low Efficiency

Traditional methods are time-consuming and inefficient. Changing logistics network design results in a need for faster and more efficient workflows.

Safety Concerns

Heavy goods in larger quantities means safety risks, and traditional forklift methods contribute to rising instances of accidents.

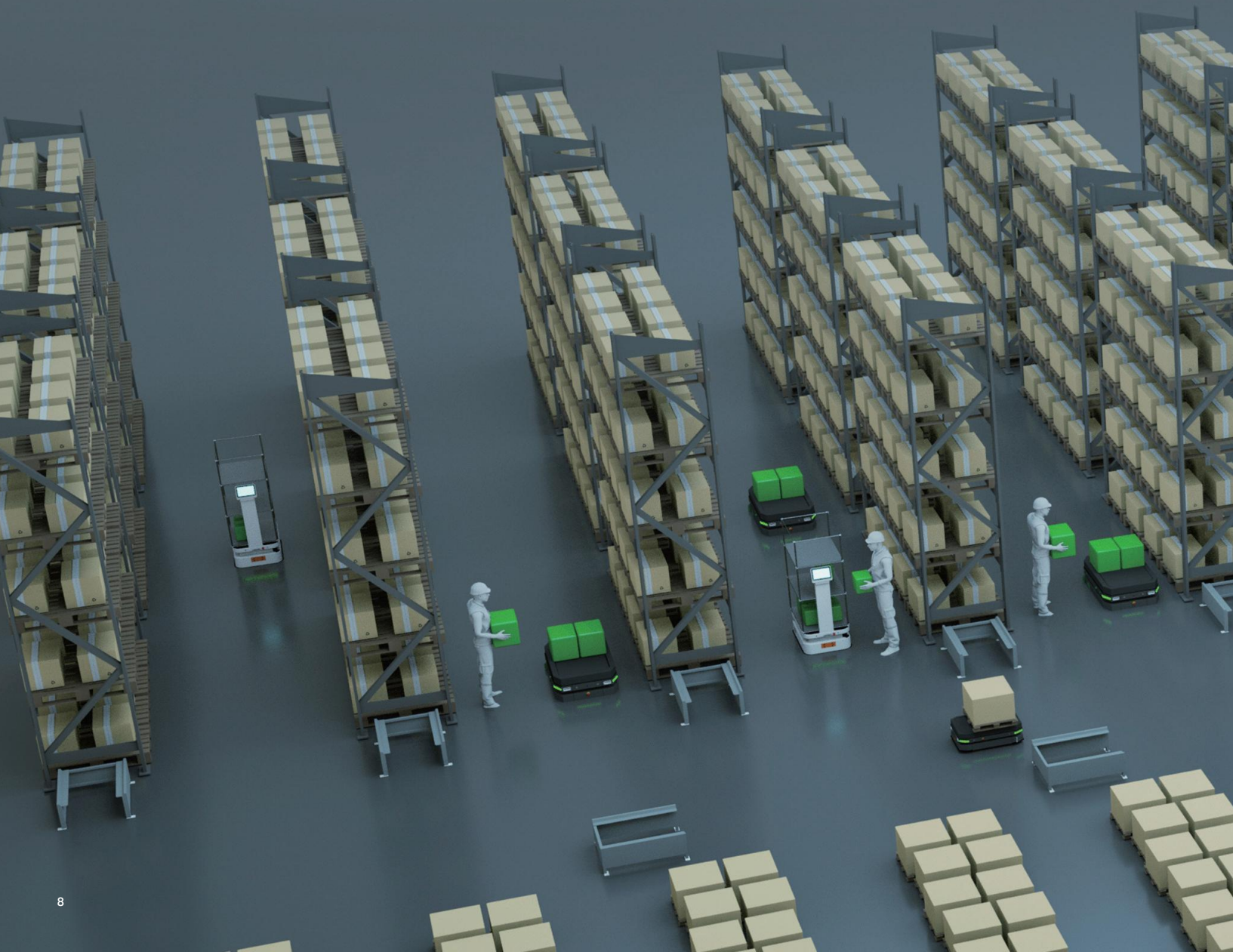

Industries



3PL



Wholesale



Omnichannel

Results We Deliver

Productivity: 2x–3x UPH Increase

ForwardX solutions increase productivity through consolidated workflows that reduce wasted time and increase output. Double or even triple your pickers' units picked per hour by removing insignificant tasks.

Accuracy: Up to 99.9% Picking Accuracy

Instead of pick lists, f(x) organizes and distributes orders directly to employees. Use on-screen visual directions and onboard RFID scanning, so your workers can pick correctly the first time, every time.

Payback: ROI in Under 9 Months

ForwardX solutions deliver immediate results. See a marked improvement and financial gain in under 2 weeks, and get a guaranteed return on investment in less than 9 months.

Efficiency: 60% Reduction in Walking Time

AMRs handle material movements, allowing employees to focus on more important tasks. Reduce traveling, picking, and order reviewing time to achieve more in a shorter period.

Savings: 50% Reduction in Labor Costs

AMRs address recruitment and turnover issues by increasing productivity and worker satisfaction. Automate repetitive workflows and redistribute your work force to cut your fully burdened labor costs in half.



DHL

DHL chose a ForwardX Flex solution to simplify picking and sorting workflows. The Flex solution consisted of a fleet of Flex 300-S AMRs with custom-built racking and f(x) Fleet Manager. The facility supports 600 retail stores with varying delivery frequencies. Increasing productivity, eliminating errors, and decreasing labor dependency was key.

Results

<2

Years ROI

3x

Productivity Increase

43%

Labor Cost Reduction



ITOCHU

ITOCHU Logistics China (ILC) chose a ForwardX Flex solution to automate picking and packing workflows in its Tianjian location. Consisting of a fleet of ForwardX Flex 300 AMRs and f(x) Fleet Manager, the solution was designed to minimize travel, reduce cognitive fatigue, lower labor dependency, and allow for rapid scalability. Onsite deployment took less than 2 weeks, and ILC was able to cut labor costs in half, double its productivity, and reach 99.99% order accuracy.

Results

2.13x

Productivity Increase

99.99%

Picking Accuracy

52%

Labor Cost Reduction



FORWARD X
ITOCHU
物流 (中国) 有限公司

014

Manufacturing

Workflows

Cart Transport

Use Flex L or Max L AMRs for point-to-point cart transportation, such as line delivery, WIP movement, and finished goods.

Pallet Transport

Use Max L AMRs for point-to-point pallet transportation, such as inbound receiving of raw materials, putaway, and production-to-warehouse movement.

Your Current Pain Points

Low Flexibility

SKUs are increasing, and product life cycles are decreasing. This means production lines must change to keep up, but current operations are too rigid.

Low Predictability

Manual operation lacks predictability due to complicated processes between lines with different cycles. Therefore, large material buffers are required.

High Labor Costs

Labor intensity is high, turnover is fast, and recruitment and training costs are high. This causes huge labor cost pressures for manufacturers.

High Error Rate

Complex material requirements and frequent iterations make operations complicated and lead to frequent errors.

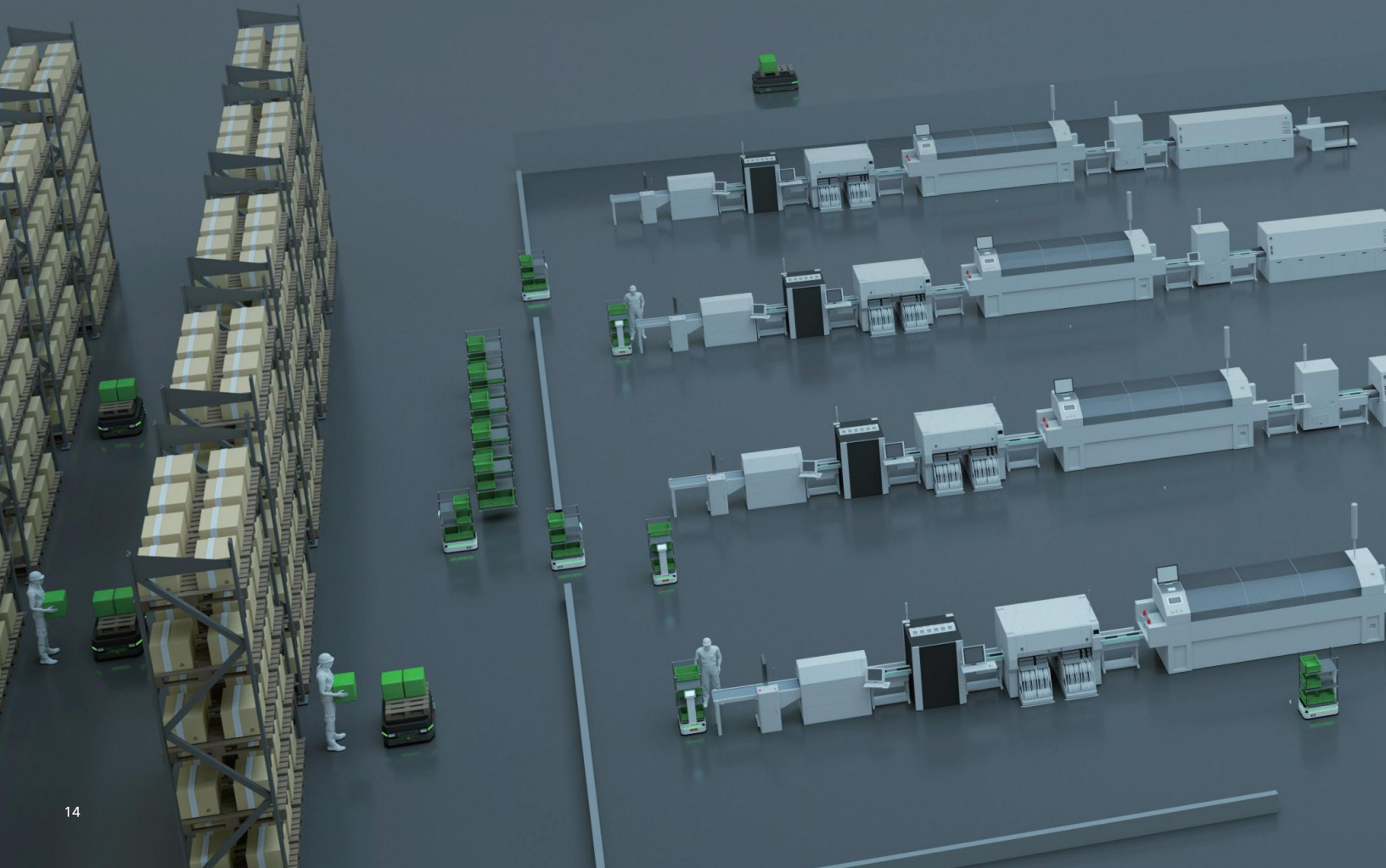

Industries



Electronics



Semiconductor



Automotive Parts



Home Appliance

Results We Deliver

Reliability: Uptime Availability of 99.5%

f(x) continuously coordinates the autonomous fleet for hands-free operations and best-in-class uptime. Automate your operations to increase predictability, reducing delays and minimizing your need for manual intervention.

Efficiency: Cycle Time Reduction

Reliable workflows improve the cadence of production and reduce waiting times. Meet your demand quicker by reducing start-to-finish production time with fewer delays.

Flexibility: Changeover Speed Increase

AMR workflows can be modified in real-time with a simple click. Reduce your changeover times and increase operational agility using f(x)'s map builder.

Savings: 50% Reduction in Labor Costs

Automating undesirable work and redeploying workers reduces recruitment requirements and keeps the workforce happy. Use ForwardX solutions to decrease turnover and bring down costs.

Payback: ROI in <2 Years

AMRs deliver a return on investment in under 2 years. Instead of waiting 5–10 years for payback, use AMRs for a quick deployment with flexible payment options, without any need for infrastructure changes.

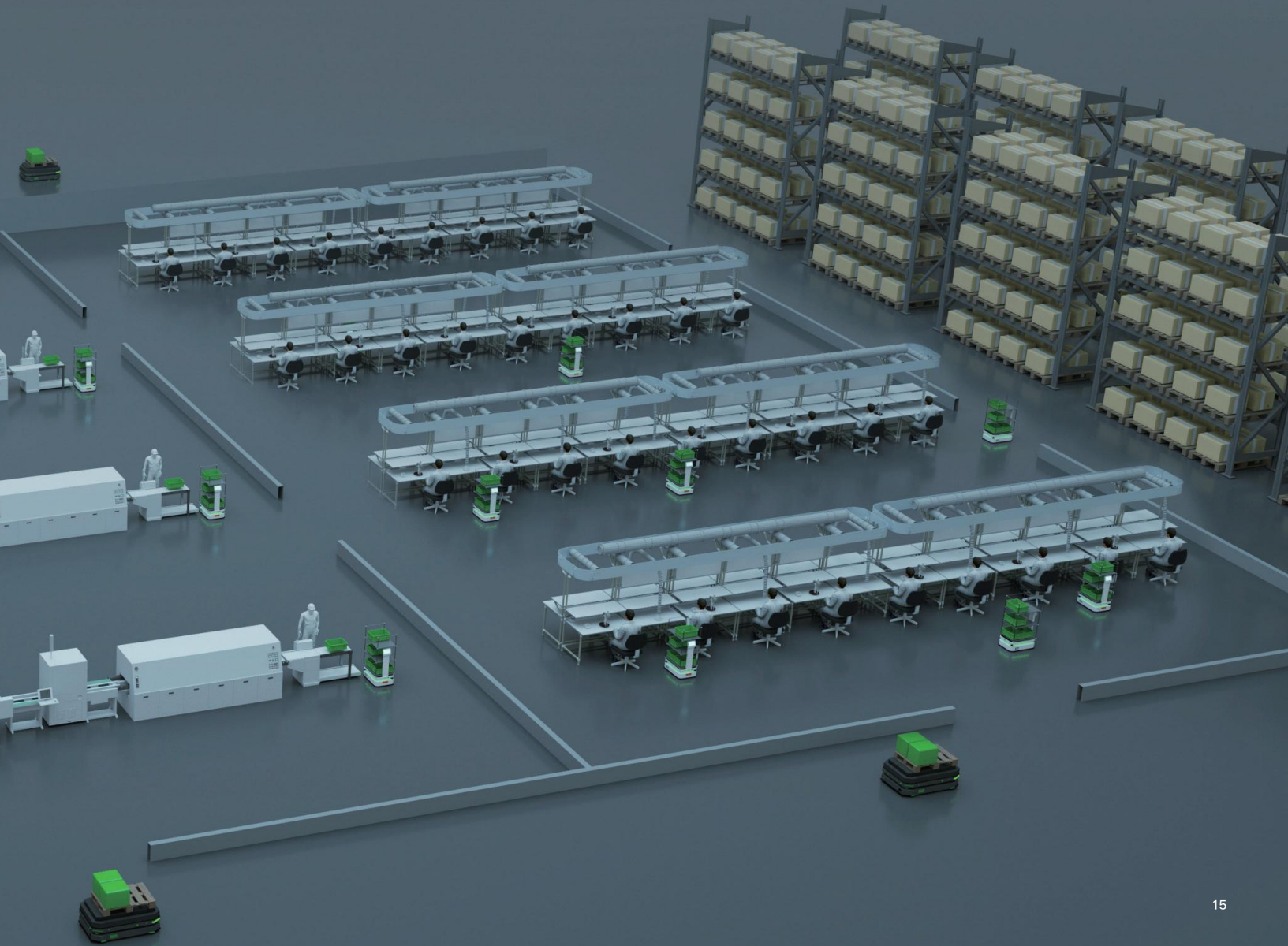

TCL



TCL chose a ForwardX Flex solution in what was the globe's first, and RBR50's Innovation Award winning, 5G-enabled AMR project to automate the movement of materials across the production facility. The solution consisted of dozens of ForwardX Flex 300-LS AMRs connected through a 5G network set up as part of TCL's 5G+ Smart Factory Initiative. The solution was designed to improve productivity, decrease labor dependency, and increase inventory turnover.

Results

360°

Obstacle Avoidance for Safe Navigation

99.5%

Uptime Availability

1st

5G-Enabled AMR Project Worldwide



Automotive: Warehouse-to-Line

Solutions

End-to-End Production Support

From receiving of raw materials, to warehouse picking, production line delivery, finished goods handling, and outbound staging, ForwardX provides a comprehensive set of solutions for automotive manufacturing.

Efficient Digitalization

Achieve full traceability of parts and process through digitization with smart automation.

Challenges

Complex Workflows

Coordination and orchestration of complex processes is difficult with manual operations. Automation adds a level of transparency and control that leads to more efficient production flow.

Low Flexibility

In today's changing landscape, rigid infrastructure & operations are no longer viable options to achieve output KPIs.

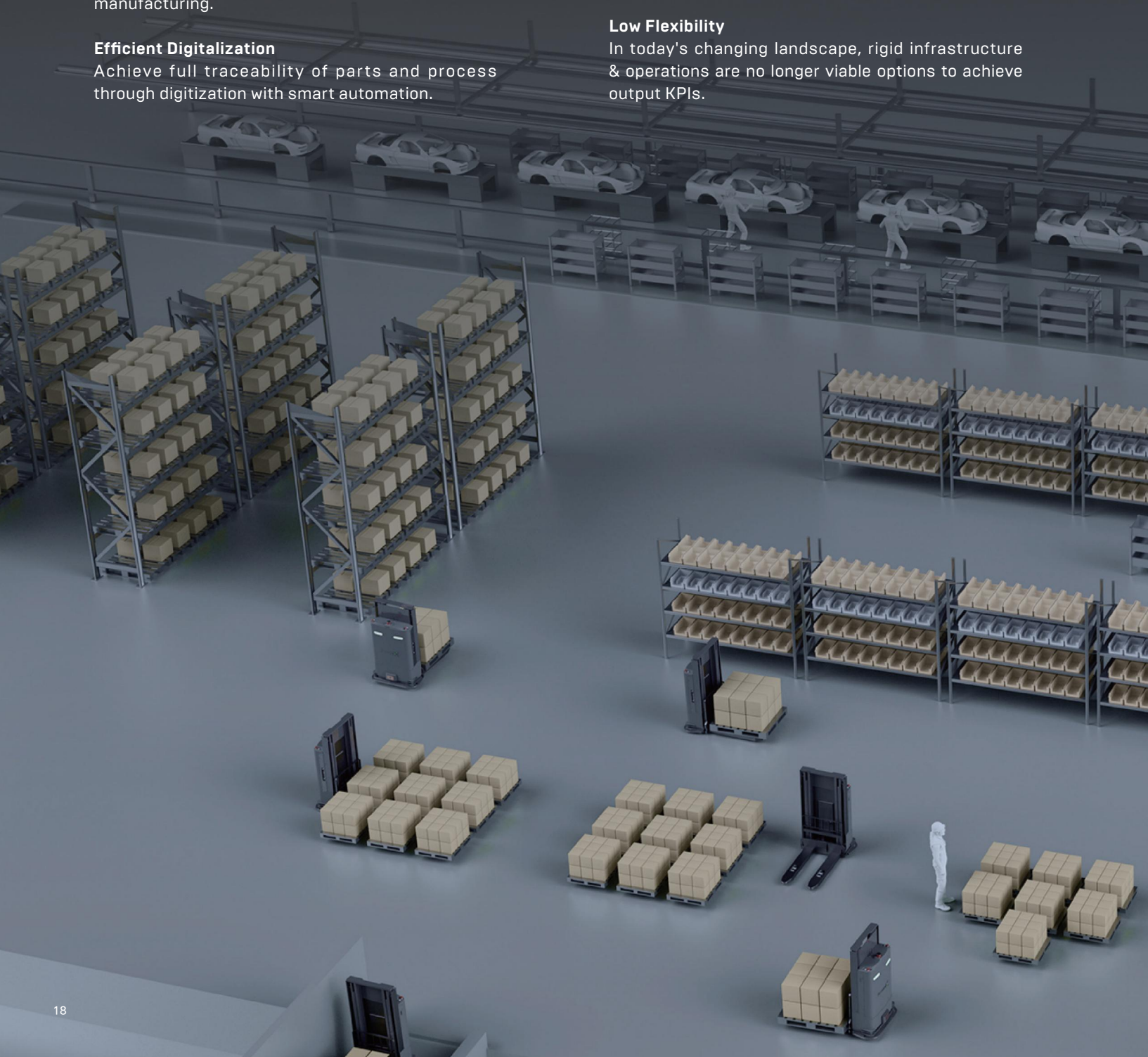

Delivering Value

Autonomous Material Transport

Automatically organize and deliver KLT, GLT, SLT, and other materials in batch and JIT workflows.

Industry 4.0

Digital Optimization

Analysis of robot operational data through smart BI and visualization tools, ForwardX helps you optimize your operations for maximum efficiency in real-time.

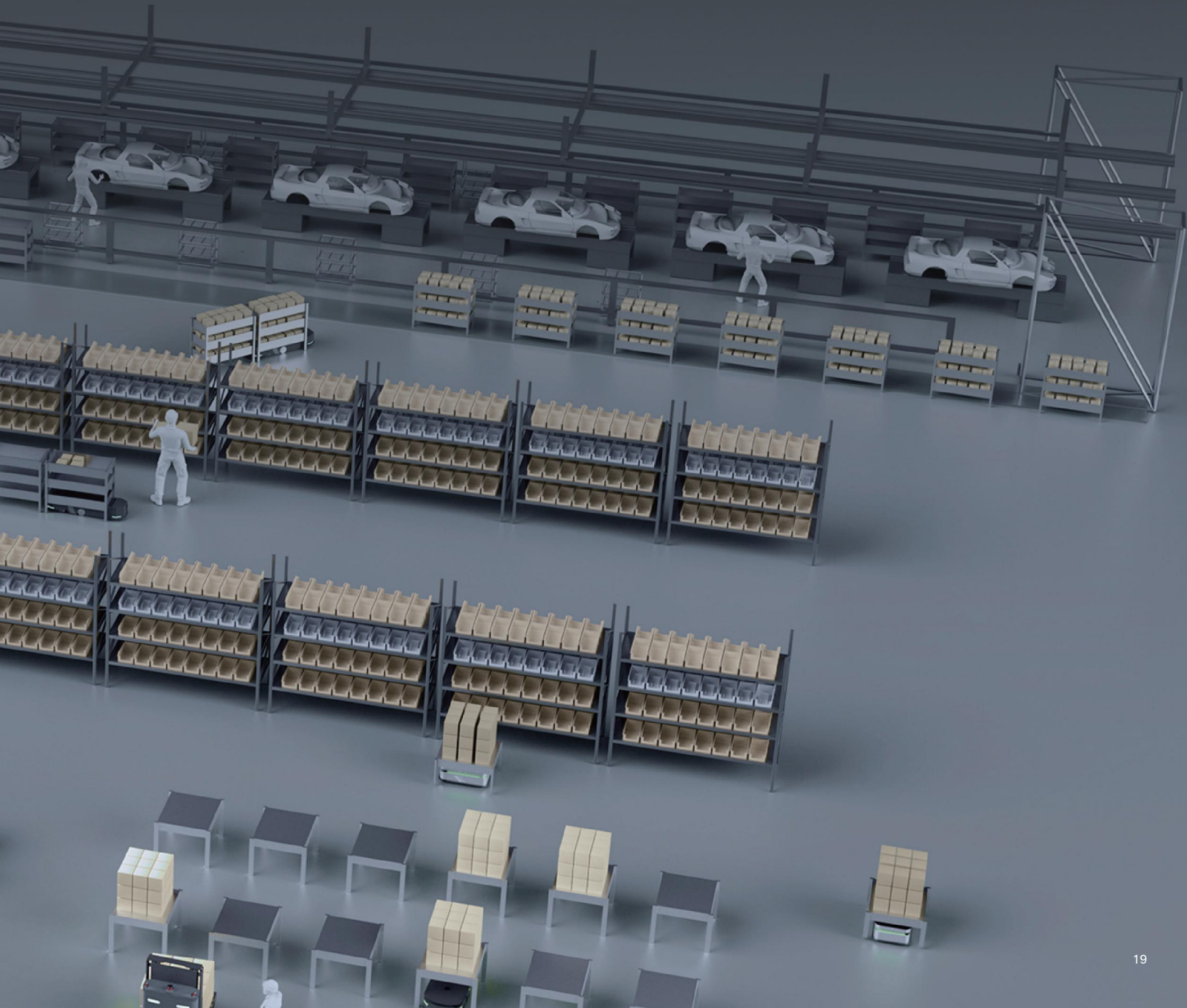

SERES

SERES Automobile Co., Ltd. is an electric vehicle (EV) and new energy vehicle (NEV) company. ForwardX Robotics deployed its Lynx series AMRs and f(x) Fleet Manager at a SERES manufacturing plant as part of a digital transformation. The project covers the final assembly workshop's assembly line, the raw material warehouse, and the fixed rotor workshop. The robots handle roughly 100 logistics tasks daily in the material collection and distribution area, the line-side storage area, and between production lines. Through practical applications, the employees on the SERES production line have significantly reduced the labor intensity of material handling and achieved digital data management and unmanned material distribution.

Pain Points

Fast-paced, changing industry

Constant production and assembly line changes

Inflexible and difficulty in adapting to new layouts



Customer Value

Intelligent task management efficiently adapts to changes

Quick deployment for various scenarios

Flexible and scalable to meet production requirements

±0.2 in

Precision Docking

Autonomous

Changeover Between Empty and Full Containers



ForwardX Matrix

The Flexible Automation Platform

ForwardX Matrix seamlessly connects with your existing software infrastructure. Once WMS is connected, the platform autonomously orchestrates your operations for maximum productivity while offering you deep insight into and control of every inch of your facility.



Top Modules and Add-ons for Smart Warehousing

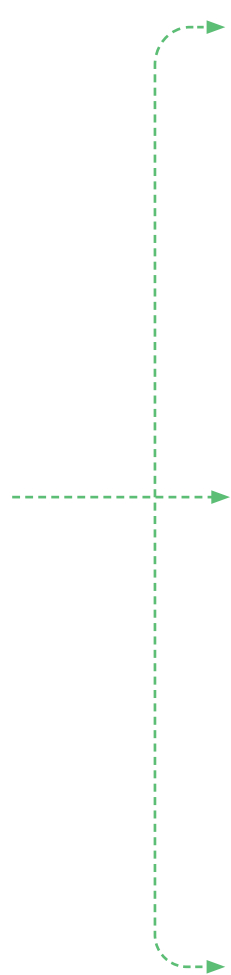

Powered by
ForwardX Cortex

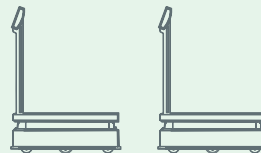

ForwardX Flex®
Visual Autonomous Mobile Robots
for up to 600kg (1,322 lbs)

Perfect for small to medium load movements like picking, Flex AMRs collaborate with human workers to remove unproductive tasks like long-distance walking and increase the efficiency and accuracy of human work.



ForwardX Max®
Visual Autonomous Mobile Robots
for up to 2,500 kg (5,511 lbs)

Built for medium to high payloads up to 2,500 kg (5,511 lbs) , Max and Max L AMRs support the automation of multiple workflows across your warehouse including heavy piece, case, and pallet picking.

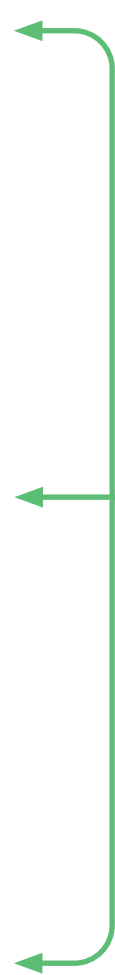



Your Systems
WMS, WCS

Seamlessly connects with f(x) through API integration, transmitting vital data back and forth from f(x).

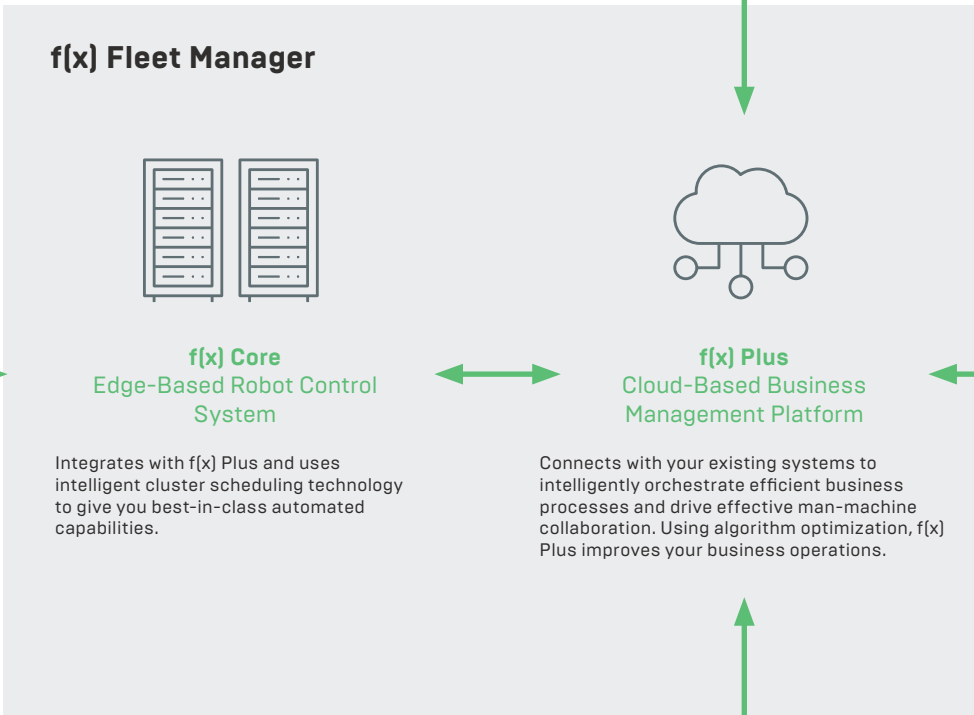

Integrates with f(x) Plus and uses intelligent cluster scheduling technology to give you best-in-class automated capabilities.

Connects with your existing systems to intelligently orchestrate efficient business processes and drive effective man-machine collaboration. Using algorithm optimization, f(x) Plus improves your business operations.



Tailored Scenario for Smart Warehousing



Other Scenarios (Retail, Health)



f(x) Dashboard
Desktop Application

Built for management level staff to control operations, track performance, and analyze data, f(x) Dashboard gives you a birds-eye view of your facility.



f(x) Mobile
Mobile Application for PDAs, Smart Watches, and Cellphones

Used by warehouse operators, supervisors, and other staff on the floor, f(x) Mobile improves human performance through directed workflows that help workers focus on value-adding activities.

ForwardX Flex 60 AMRs

Flexible and Lightweight AMR

Flex 60-L is suitable for ultra-narrow aisle scenarios and is equipped with lifting and lightweight shelves to meet the small load handling applications in the manufacturing industry. The ultra-narrow body design allows for more flexible transport through the facility, so as to complete tasks efficiently and safely.

Flex 60-S is designed for human-machine collaboration and excels in ultra-narrow aisles. Equipped with RGBD cameras and sophisticated sensors, it boasts exceptional 3-D spatial awareness within 1.5 meters high. Guaranteeing safety and efficiency, Flex 60-S works seamlessly alongside human workers for optimized picking processes. For piece picking scenarios that require an extra level of precision, add on autonomous weighing scales for unbeatable picking accuracy.



Flex 60-L



Flex 60-S



Flex 60-L



Flex 60-S

Dimensions	Length	600 mm (23.62 in)	600 mm (23.62 in)
	Width	480 mm (18.89 in)	480 mm (18.89 in)
	Height	417 mm (16.41 in)	1,500 mm (62.95 in)
	Turning Diameter	707 mm (27.83 in)	707 mm (27.83 in)
Payload	Weight	90 kg (198 lbs)	90 kg (198 lbs)
	Max. Payload	60/80 kg (132/176 lbs)	60/80 kg (132/176 lbs)
	Load Surface	580x365 mm (22.83x14.01 in)	470x470 mm (18.5x18.5 in)
	Lift	85 mm (3.34 in)	-
	Weighing Scale	-	Optional
Performance	Positioning Mode	Laser SLAM/ Visual / Optional QR Code Navigation	
Communication	Wi-Fi (IEEE 802.11a/b/g/n/ac)	Yes	
	Cellular Network (Public 4G/5G)	Optional	
Power	Endurance	~8 hrs Per Charge	
	Battery Type	LFP	
Sensors	LiDAR	1	1
	UWA Cameras	1	1
	Marker Camera	1	-
	3D Camera	1	2
Interaction	Audio	Yes	Yes
	Lights	Yes	Yes
	HMI	-	Yes
Safety	Safety Bumper	Yes	
	Emergency Stop Button	1	
	Audible And Visual Alarm	Yes	
	Movement Obstacle Perception	Yes	
Compliance	CE	Optional	

ForwardX Flex AMRs

Intelligently Reshaping Warehousing and Manufacturing Business Processes

Flex 300-L/600-L are equipped with a lifting function, that when combined with the sensors and cameras allow for autonomous rack position detection and docking. The fully unmanned handling of racks and picking containers reduces personnel involvement and drastically increases efficiency and productivity in the picking process.

The Flex 300-LS is equipped with a lifting function for autonomous rack docking and an interactive touchscreen with customizable UI for operation efficiency improvement.



Flex 300-L
Flex 600-L



Flex 300-LS



Flex 300-L



Flex 600-L



Flex 300-LS

Dimensions

Length	950 mm [37.40 in]	950 mm [37.40 in]	950 mm [37.40 in]
Width	650 mm [25.59 in]	650 mm [25.59 in]	650 mm [25.59 in]
Height	330 mm [12.99 in]	330 mm [12.99 in]	295 mm [11.61 in]
Lifting Height	60 mm [2.36 in]	60 mm [2.36 in]	1,240 mm [48.81 in]
Ground Clearance	20 mm [0.78 in]	20 mm [0.78 in]	20 mm [0.78 in]
Turning Diameter	1,120 mm [44.09 in]	1,120 mm [44.09 in]	1,120 mm [44.09 in]

Payload

Weight	130 kg [286 lbs]	150 kg [330 lbs]	140 kg [308 lbs]
Max. Payload	300 kg [661 lbs]	600 kg [1,322 lbs]	300 kg [661 lbs]
Load Surface	670x390 mm [26.37x15.35 in]	670x390 mm [26.37x15.35 in]	670x390 mm [26.37x15.35 in]

Performance

Navigation Mode	Natural / Road Network / Hybrid
Positioning Mode	Laser SLAM / Visual / Optional QR Code Navigation

Communication

Wi-Fi (IEEE 802.11a/b/g/n/ac)	Yes
Wi-Fi (IEEE 802.11ax)	Optional
Cellular Network (Public 4G/5G)	Optional
Cellular Network (Private LTE)	Optional

Power

Endurance	~8 hrs Per Charge
Battery Type	LFP
Charging Mode	DC CC-CV
Battery Swap	Yes

Sensors

LIDAR	2
UWA Cameras	1
Marker Camera	2
3D Cameras	1
Odometer	1
IMU	1

Interaction

Audio	Yes	Yes	Yes
Lights	Yes	Yes	Yes
Screen	-	-	Yes

Safety

Safety Bumper	Yes
Emergency Stop Button	2

Compliance

CE	Yes
----	-----

ForwardX Flex AMRs

Intelligently Reshaping Warehousing and Manufacturing Business Processes

Flex 300-S integrates a touch-screen interface directly attached to the AMR. The software can be adapted to users' needs with visuals, bar codes, item quantities, etc.

Flex 300-SCB is the triple decker AMR and can be equipped with optional printers, RFID scanners, and barcode scanners. The three-level design allows employees to organize shipments as they are picked. Simple on-screen instructions and pick-to-light guidance significantly reduces the time it takes to pick, pack, and review every order leading to a drastic improvement in worker efficiency and units picked per hour.

Flex 600-ST is a one-of-a-kind towing AMR. Equipped with an on-board screen for streamlined workflows, and advanced sensors offering complete 360° obstacle recognition, this autonomous tugger is the epitome of safety and efficiency. Let Flex 600-ST handle all the tugging, towing, and pulling, to revolutionize your warehouse operations.



Flex 300-S



Flex 300-SCB



Flex 600-ST



Flex 300-S



Flex 300-SCB



Flex 600-ST

Dimensions

Length	950 mm (37.40 in)	950 mm (37.40 in)	1,300 mm (51.18 in)
Width	650 mm (25.59 in)	650 mm (25.59 in)	650 mm (25.59 in)
Height	1,240 mm (48.81 in)	1,600 mm (62.99 in)	1,240 mm (48.81 in)
Ground Clearance	20 mm (0.78 in)	20 mm (0.78 in)	20 mm (0.78 in)
Turning Diameter	1,120 mm (44.09 in)	1,120 mm (44.09 in)	1,600 mm (65.35 in)

Payload

Weight	100 kg (220 lbs)	128 kg (282 lbs)	160 kg (352 lbs)
Max. Payload	300 kg (661 lbs)	300 kg (661 lbs)	600 kg (1,322 lbs)
Load Surface	846x640 mm (33.30x25.19 in)	846x635 mm (33.30x25 in)	950x650 mm (37.4x25.5 in)
Towing Module	-	-	Yes
Towing Capacity	-	-	500 kg (1,102 lbs)
Ground Clearance [Towing Module]	-	-	120-320 mm (4.72-12.59 in)

Performance

Navigation Mode	Natural / Road Network / Hybrid
Positioning Mode	Laser SLAM / Visual / Optional QR Code Navigation

Communication

Wi-Fi (IEEE 802.11a/b/g/n/ac)	Yes
Wi-Fi (IEEE 802.11ax)	Optional
Cellular Network (Public 4G/5G)	Optional
Cellular Network (Private LTE)	Optional

Power

Endurance	~8 hrs Per Charge
Battery Type	LFP
Charging Mode	DC CC-CV
Battery Swap	Yes

Sensors

LiDAR	2	2	3
UWA Cameras	1	1	1
Marker Camera	2	2	1
3D Cameras	1	1	1
Odometer	1	1	1
IMU	1	1	1

Interaction

Audio	Yes
Lights	Yes
Screen	Yes

Safety

Safety Bumper	Yes
Emergency Stop Button	2

Compliance

CE	Yes	Yes	Optional
----	-----	-----	----------

ForwardX Conveyor AMRs

Automatic Loading, Unloading, and Docking with AS/RS

ForwardX Conveyor AMRs are suitable for transporting and handling a variety of containers including totes and pallets. They can be incorporated with your existing production lines or automatic storage and retrieval systems (AS/RS).

Our Conveyor AMRs are extensions of our Flex and Max series. Depending on your business needs, these AMRs can be customized to include up to two layers and two rows of rollers, such as one row on the bottom layer with two rows on the top layer.

Conveyor accessories can be customized according to customer requirements.





Flex 300 Conveyor
[2 Layers, 2 Rows]

Length	1,050 mm (41.3 in)
Width	650 mm (25.6 in)
Height	1,186 mm (46.7 in)
Payload Capacity	50 kg (110 lbs) per shelf
Load Surface Area	650x365x200 mm [25.6x14.3x7.9 in]
Loading Height	Bottom Layer: 555 mm (21.8 in) Top Layer: 1,150 mm (45.3 in)



Flex 300 Conveyor 1 Layers, 2 Rows



Flex 300 Conveyor 2 Layers, 1 Row



Flex 300 Conveyor 1 Layer, 1 Row

ForwardX Max AMRs

Point-to-Point, End-to-End Smart Transportation

The Max series brings the flexibility of the Flex series to the larger and heavier goods and materials in your facility, which is suited for pallet- and case-picking for B2B store replenishments and B2C eCommerce fulfillment or heavy-duty material movement at your manufacturing plant.

The Max L series is equipped with a lifting function, that when combined with the onboard sensors and cameras allows the AMRs to autonomously locate pallets or other larger racks and work with forklifts to automate pallet-based receiving, putaway, replenishment, raw material movement, and shipping workflows.



Max 600



Max 600-L



Max 600



Max 600-L

Dimensions

Length	1,380 mm [54.33 in]	1,380 mm [54.33 in]
Width	900 mm [35.43 in]	900 mm [35.43 in]
Height	320 mm [12.60 in]	335 mm [13.18 in]
Ground Clearance	25 mm [0.98 in]	25 mm [0.98 in]
Turning Diameter	1,600 mm [62.99 in]	1,600 mm [62.99 in]

Payload

Weight	260 kg [573 lbs]	380 kg [837 lbs]
Max. Payload	600 kg [1,322 lbs]	600 kg [1,322 lbs]
Load Surface	1,380x900 mm [54.33x35.43 in]	1,200x720 mm [47.24x28.34 in]

Function

Lifting Height	-	60 mm [2.36 in]
----------------	---	-----------------

Performance

Navigation Mode	Natural / Road Network / Hybrid
Positioning Mode	Laser SLAM / Visual / Optional QR Code Navigation

Communication

Wi-Fi (IEEE 802.11a/b/g/n/ac)	Yes
Wi-Fi (IEEE 802.11ax)	Optional
Cellular Network (Public 4G/5G)	Optional
Cellular Network (Private LTE)	Optional

Power

Endurance	~10 hrs Per Charge	~9 hrs Per Charge
Battery Type	LFP	LFP
Charging Mode	DC CC-CV	DC CC-CV
Battery Swap	Yes	Yes

Sensors

LiDAR	2
UWA Cameras	1
Marker Camera	2
3D Cameras	2
Odometer	1
IMU	1

Interaction

Audio	Yes
Lights	Yes

Safety

Safety Bumper	Yes
Emergency Stop Button	2

Compliance

CE	Yes
----	-----

ForwardX Max AMRs

Point-to-Point, End-to-End Smart Transportation

Max 1500-L Slim is specifically designed for case picking applications. With full 360° obstacle detection and avoidance, a loading capacity of 1,500 kg (3,306 lbs), highly precise docking capabilities and lifting functions for pallets and racks, it excels in safely and efficiently transporting medium-sized and heavier goods in case picking scenarios.

Max 02500-L supports omnidirectional towing with a maximum load capacity of 2,500 kg (5,511 lbs), capable of operating flexibly in relatively restricted working environments, greatly enhancing the flexibility and safety of production lines. At the same time, the AMR is equipped with a powerful jacking system that can support the jacking of oversized shelves, helping to improve productivity and ease of work.



Max 1500-L Slim



Max 02500-L



Max 1500-L Slim

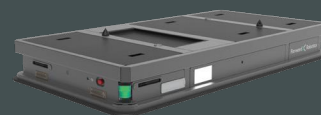

Max 02500-L

Dimensions	Length	1,250 mm (49.21 in)	2,100 mm (82.67 in)
	Width	850 mm (33.46 in)	1,100 mm (43.30 in)
	Height	245 mm (9.64 in)	310 mm (12.20 in)
	Ground Clearance	25 mm (0.98 in)	30 mm (1.18 in)
	Turning Diameter	1,294 mm (50.94 in)	2,239 mm (88.14 in)
Payload	Weight	250 kg (551 lbs)	700 kg (1,543 lbs)
	Max. Payload	1,500 kg (3,306 lbs)	2,500 kg (5,511 lbs)
	Load Surface	1,200x830 mm (47.24x32.67 in)	2,100x1,100 mm (82.67x43.3 in)
Function	Lifting Height	60 mm (2.36 in)	145 mm (5.70 in)
Performance	Navigation Mode	Natural / Road Network / Hybrid / Follow	
	Positioning Mode	Laser SLAM / Visual / Optional QR Code Navigation	
Communication	Wi-Fi (IEEE 802.11a/b/g/n/ac)	Yes	
	Wi-Fi (IEEE 802.11ax)	Optional	
	Cellular Network (Public 4G/5G)	Optional	
	Cellular Network (Private LTE)	Optional	
Power	Endurance	~8 hrs Per Charge	~7 hrs Per Charge
	Battery Type	LFP	LFP
	Charging Mode	DC CC-CV	DC CC-CV
	Battery Swap	Yes	Yes
Sensors	LiDAR	2	2
	UWA Cameras	1	2
	Marker Camera	1	2
	3D Cameras	Optional (0-2)	Optional (0-2)
	QR Code Cameras-downward	1	1
	Odometer	1	1
	IMU	1	1
Interaction	Audio	Yes	
	Lights	Yes	
Safety	Safety Bumper	Yes	
	Emergency Stop Button	2	
Compliance	CE	Yes	Optional

ForwardX Lynx AMRs

Redefining Flexibility in the Automotive Industry

The Lynx series is designed to solve pain points in the automotive manufacturing industry. Lynx uses deep learning computer vision paired with a LiDAR-based SLAM navigation system making it suitable for stable operations in a complex environment. It works alongside personnel, other AMRs, and customers' existing automation equipment without a need for remodeling or laying out magnetic strips or other fixed routes. Lynx is the most flexible AMR built for the automotive industry that is driving efficiency with rapid deployment and leading to quick ROI.



Lynx U1000

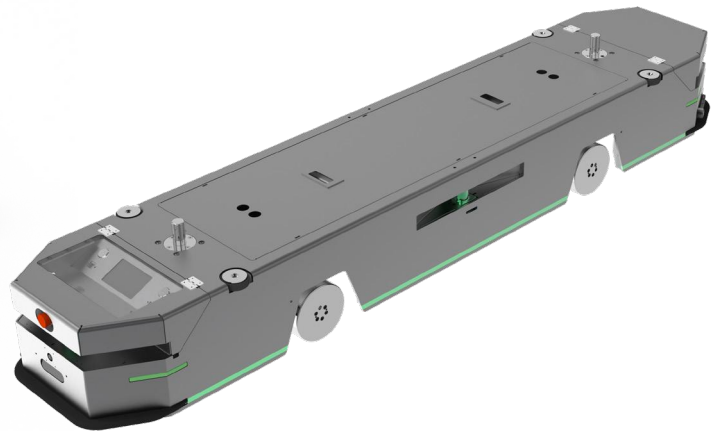

Lynx O1500

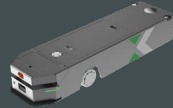

Lynx U1000

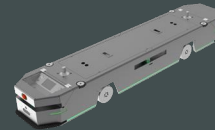

Lynx O1500

Dimensions

Length	1,610 mm (63.38 in)	2,200 mm (86.61 in)
Width	440 mm (17.32 in)	440 mm (17.32 in)
Height	285 mm (11.22 in)	285 mm (11.22 in)
Ground Clearance	25 mm (0.98 in)	25 mm (0.98 in)
Turning Diameter	3,168 mm (124.72 in)	2,254 mm (88.74 in)

Payload

Weight	240 kg (529 lbs)	340 kg (749 lbs)
Max. Payload	1,000 kg (2,204 lbs)	1,500 kg (3,306 lbs)

Function

Configuration	Yes	Yes
Towing Hook	1	2
Lifting Height	50 mm (1.96 in)	50 mm (1.96 in)

Performance

Navigation Mode	Natural / Road Network / Hybrid
Positioning Mode	Laser SLAM / Visual / Optional QR Code Navigation

Communication

Wi-Fi (IEEE 802.11a/b/g/n/ac)	Yes
Wi-Fi (IEEE 802.11ax)	Optional
Cellular Network (Public 4G/5G)	Optional
Cellular Network (Private LTE)	Optional

Power

Endurance	~8 hrs Per Charge	~9 hrs Per Charge
Battery Type	LFP	LFP
Charging Mode	DC CC-CV	DC CC-CV
Q.D.	Yes	Yes

Sensors

LiDAR	1	4
UWA Cameras	1	2
3D Cameras	Optional (0-2)	Optional (0-1)
QR Code Cameras-downward	1	1
Odometer	1	1
IMU	1	1

Interaction

Audio	Yes	Yes
Lights	Yes	Yes
HMI	Yes	Yes

Safety

Safety Bumper	Yes	Yes
Emergency Stop Button	2	2

Compliance

CE	Optional
----	----------

ForwardX Apex AMRs

The Most Intelligent Auto-vision Forklift

Add Apex autonomous forklifts to your workflows for a safer and more productive environment. Apex AMRs will automate pallet movement to free up employees to focus on value-added picking time, returns processes, and/or shipment packing and organization.

Through the leading multi-sensor fusion technology and computer vision, Apex accurately perceives any changes in its environment of static and/or mobile obstacles and is able to identify the angle at which a pallet is positioned and adjust autonomously in real-time.

- Apex 1400-L works with AMRs, pallet stations, and other automation equipment for end-to-end pallet movement in your warehouse for payloads of up to 1,400 kg (3,086 lbs).
- Apex C1500-L is the most versatile autonomous forklift that works together with other AMRs and automation equipment; is compatible with GMA and Euro pallets; and covers end-to-end pallet movement, pallet stacking, high shelf receiving and putaway for payloads up to 1,500 kg (3,306 lbs).



Apex 1400-L



Apex C1500-L



Apex 1400-L



Apex C1500-L

Dimensions	Length	1,830 mm (72.04 in)	2,763 mm (108.77 in)
	Width	1,010 mm (39.76 in)	1,240 mm (48.81 in)
	Height	1,900 mm (74.8 in)	2,183 mm (85.94 in)
	Height (With Extension)	2,180 mm (85.82 in)	4,040 mm (159.05 in)
	Turning Diameter	2,260 mm (88.97 in)	-
Payload	Weight	880 kg (1,940 lbs)	2,700 kg (5,952 lbs)
	Max. Payload	1,400 kg (3,086 lbs)	1,500 kg (3,306 lbs)
Function	Configuration	Yes	Yes
	Fork Dimensions	1,160/170/60 mm (45.66/6.69/2.36 in)	1,250/122/40 mm (49.21/4.80/1.57 in)
	Fork Carriage Width	680/560 mm (26.77/22.04 in)	680/560/460 mm (26.77/22.04/18.11 in)
	Default Fork Height	85 mm (3.34 in)	40 mm (1.57 in)
	Max. Fork Height (Customizable)	1,600 mm (62.99 in) Max: 3,500 mm (137.79 in)	3,000 mm (118.11 in) Max: 4,500 mm (177.16 in)
	Load Center	600 mm (23.62 in)	500 mm (19.68 in)
Performance	Navigation Mode	Natural / Road Network / Preferred Path	Road Network / Hybrid / Preferred Path
	Positioning Mode	Laser SLAM / Visual Semantics	Laser SLAM / Visual Semantics / Optional QR Code Navigation
Communication	Wi-Fi (IEEE 802.11a/b/g/n/ac)	Yes	
	Cellular Network (Public 4G/5G)	Optional	
	USB Type-A Interface	Optional	
	Network Interface (RJ45)	Optional	
Power	Endurance	~10 hrs Per Charge	~8 hrs Per Charge
	Battery Type	LFP	LFP
Sensors	Lidar	4	5
	UWA Cameras	1	2
	3D Camera	1	-
	Pallet In-Place Sensor	2	2
	Pallet Off-Position Sensor	2	2
Safety	Safety Bumper	Yes	
	Emergency Stop Button	Yes	
Compliance	CE	Yes	Yes

f(x) Fleet Manager

Take Control of Your Warehouse

ForwardX f(x) Fleet Manager is an Industry 4.0-compatible solution that provides end-to-end automation and future-proof digitization. Acting as your command center, f(x) Fleet Manager connects with your software platforms to receive, optimize, and dispatch tasks in one central location.

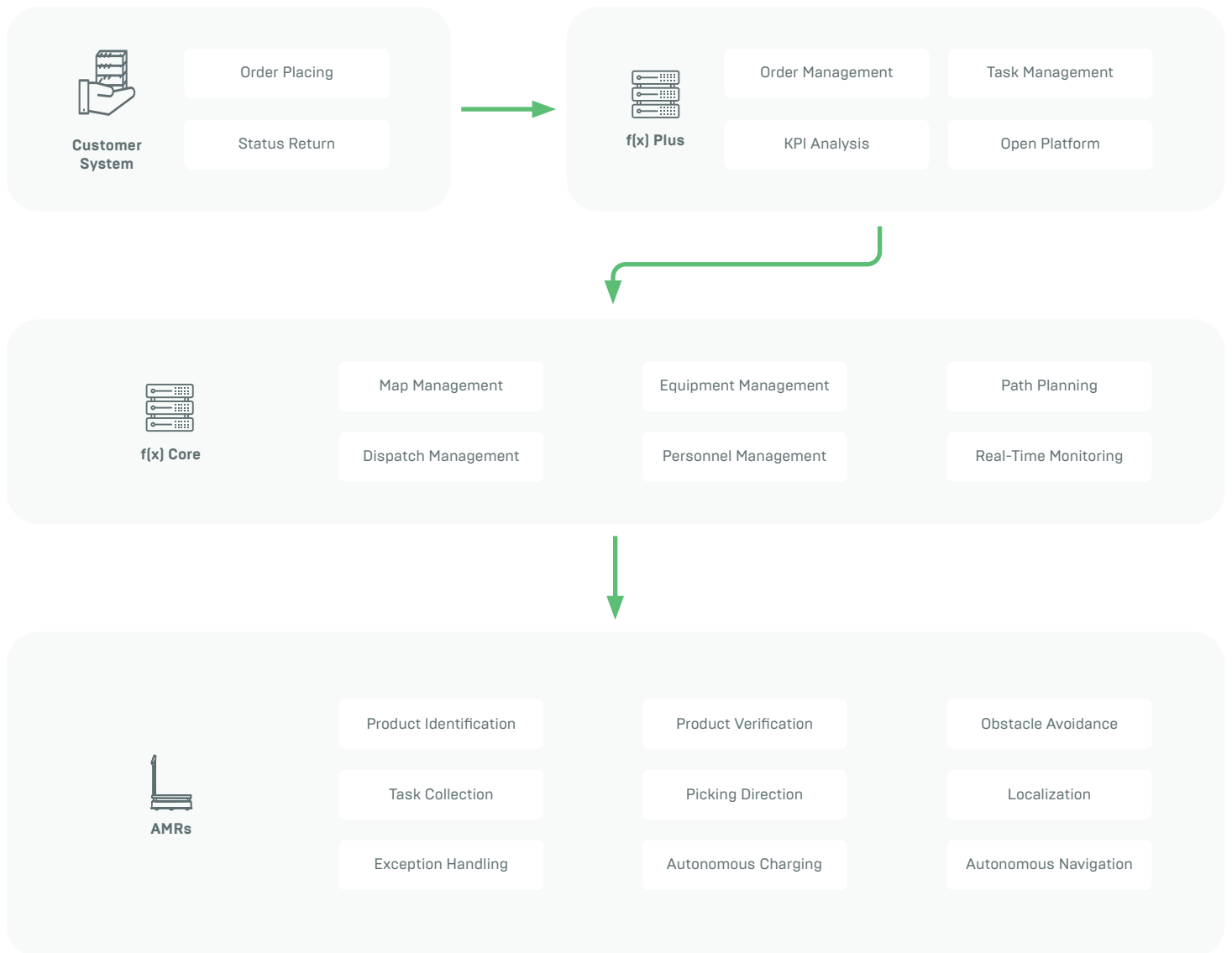

Key Features



Unmatched AMR Fleet Capacity

Expand your fleet with no growing pains. Our best-in-class machine learning algorithms ensure your Fleet Manager will intelligently manage and orient your robots to their environment, regardless of robot density, rack density, or picking strategy.



Traffic & Congestion Control

Relieve congestion and alleviate inefficiency caused by traffic with a truly intelligent solution. Our Fleet Manager provides machine learning-based traffic and congestion control to address bottlenecks, like auto-door delays from required manual intervention.



Productivity and Efficiency Tracking

Understand how productive and efficient your fleet can be as you watch in real-time. Our dashboards provide customization so that you can see exactly how your fleet operates, helping you make changes where they matter.



Optimized Battery Management for 24/7 Operation

Benefit from superior uptime effortlessly. ForwardX's Fleet Manager automatically optimizes a battery management schedule to keep your site moving forward non-stop.

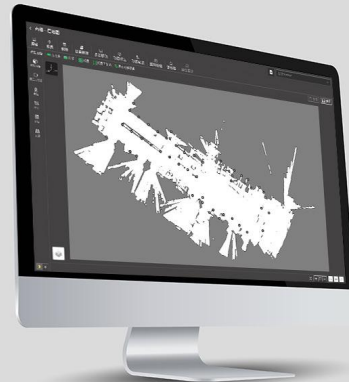
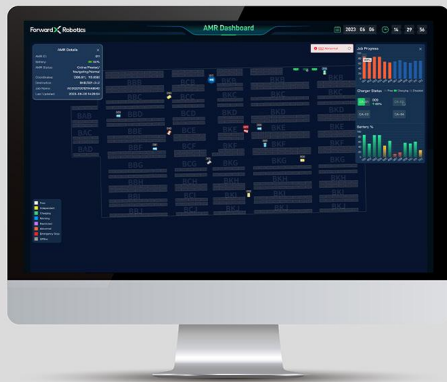
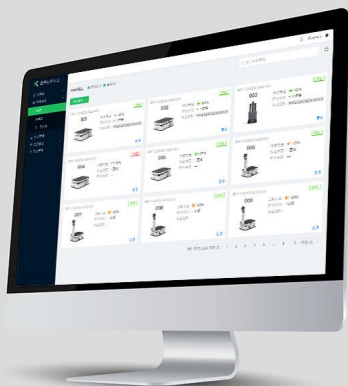

Intelligent Job Assignment

f(x) receives, organizes, and assigns tasks according to your operational strategy. Constantly monitoring and anticipating your operations, f(x) reduces wasted time and movement by using Artificial Intelligence to assign tasks for the best results.



Automatic Updates

f(x) provides automatic over-the-air updates to every AMR within your fleet to ensure your fleet is up to date with our latest improvements.



Seamless Integration

f(x) connects to your existing operational systems, such as your WMS, MES, or ERP, without any hassle. Once connected, f(x) circulates tasks across your fleet automatically and in real-time.



Smart Device Collaboration

If you have elevators or automatic doors in your facility, f(x) empowers your fleet to intelligently interact with and navigate through tricky environments. For example, f(x) allows Flex AMRs to wait for and enter elevators together.



Optimized Utility

ForwardX solutions are made to be flexible and versatile to enable you to put them to work across your facility. Based on the tasks available, f(x) will ensure that your robots contribute value wherever possible.



Customizable Dashboards

In f(x), you can customize the way you see data, prioritizing metrics most important to you. With the data constantly at your fingertips, you can create actionable plans to improve your business.

About ForwardX

ForwardX Robotics is a global leader in vision-based AMR technology, delivering innovative end-to-end material handling solutions for warehousing and manufacturing facilities. With its advanced fleet management software and the widest range of vision-first Autonomous Mobile Robots (AMRs), ForwardX Robotics helps businesses achieve higher performance and value within their supply chain operations. The company is comprised of over 250 members hailing from top universities and leading enterprises around the world. As shown by the 350+ patents and its award-winning research work, such as Frost & Sullivan's Best Practices Award and Robotics Business Review's RBR50 Innovation Award, ForwardX Robotics continues to push the boundaries of innovation.

ForwardX has deployed over 3,000 AMRs in over 220 facilities across 5 continents. With offices in the US, Japan, Korea, and China along with partnerships around the globe, ForwardX is expanding and applying its proven solutions to empower the workforce of tomorrow.

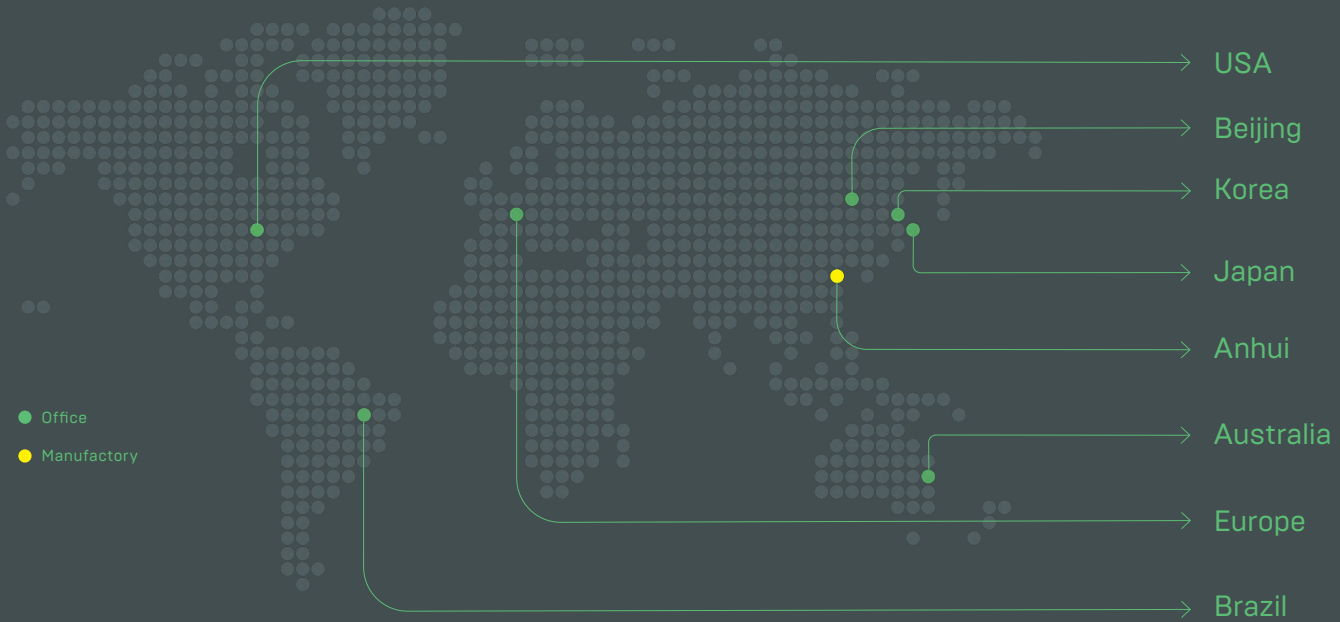

Customers

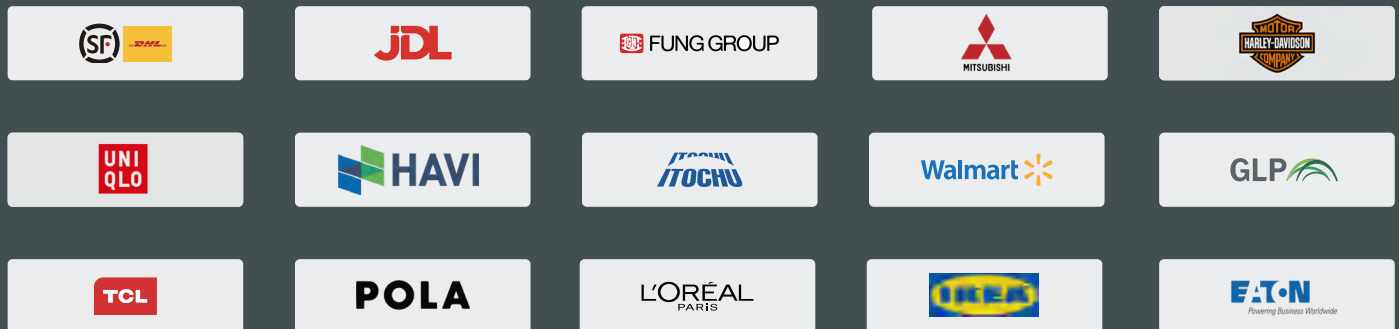

Better Performance Better Value



Sales

sales.us@forwardx.com

PR & Media

pr.us@forwardx.com

Website

www.forwardx.com



@ForwardX_US



ForwardX Robotics



ForwardX Robotics

