



RFID Tags Data Sheet - Passive Low Frequency (LF) For:



R³⁻² = 125 KHz Smart Antennas

R³⁻¹ = 125 KHz Legacy Readers

R³ = 148 KHz Legacy Readers

134.2 KHz ISO 11784 & 11785

EEPROM memories ranging from 10 bytes RO (read only) to 2048 bytes RW (read write)

NXP - Hitag1, Hitag2, HitagS

Atmel - T5557, T5567, ATA5575/5577

EM - EM4100, EM4102, EM4200

EM - EM4105, EM4205, EM4305, EM4450

Frequency - All Tags are 125 KHz unless specifically called out as 134.2 KHz or 148 KHz although any Tag can be customized to be 134.2 KHz or 148 KHz.

Memory Chip - All part numbers referenced in this document contain RFID, Inc.'s proprietary EEPROM. Add suffix to part number with chips above to order a specific chip, for example -Hitag1 or -EM4450. Also HID compatible. **Read Ranges** - See Matrix on page 23.



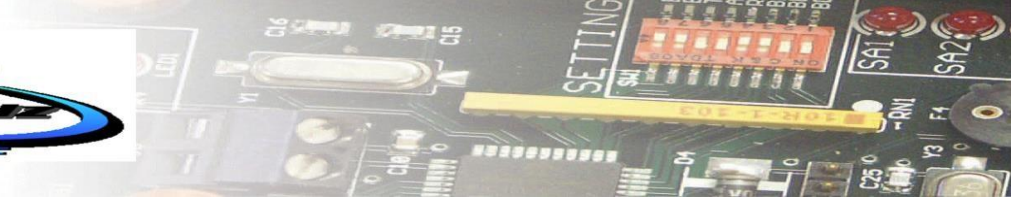

Clear Laminate Disc Tags

Model 1760 Series

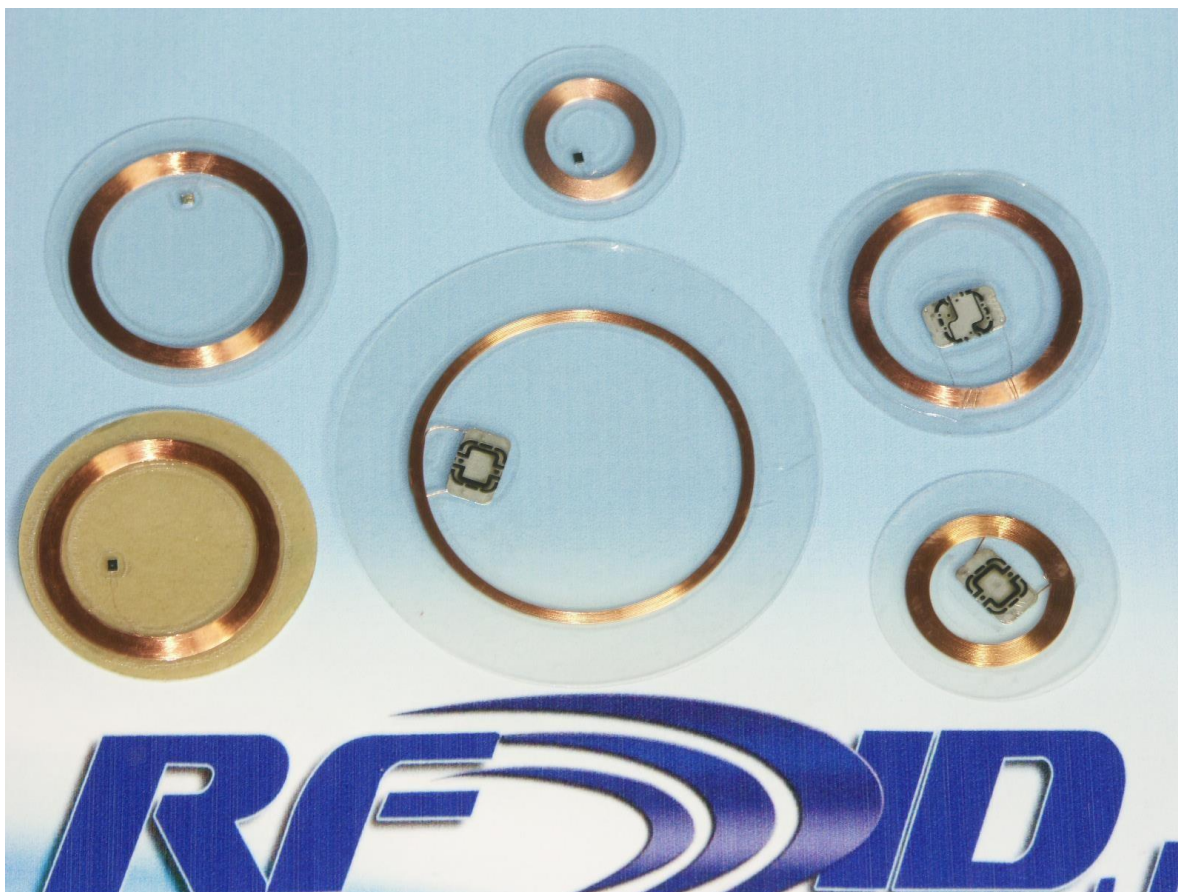

Specifications:	Dimensions:	20mm, 30mm, 50mm	Custom Sizes Available
	Material:	Clear Laminate	Option Peel & Stick Backing
	Storage Temperature:	-40°F to 185°F	-40°C to +85°C
	Operating Temperature:	-40°F to +131°F	-40°C to +55°C
	Ingress Protection:	IP-67	

Part Numbering	Description	Model Number	Part Number
RO = Read Only	20mm RO	1760-20-RO	800-0119-02
RW = Read Write	20mm RW	1760-20-RW	800-0119-03
P/S = Peel & Stick	20mm P/S RO	1760-20-P/S-RO	800-0119-04
	20mm P/S RW	1760-20-P/S-RW	800-0119-05
For 134.2 KHz add suffix to P/N of -134	30mm RO	1760-30-RO	800-0100-00
	30mm RW	1760-30-RW	800-0100-01
	30mm P/S RO	1760-30-P/S-RO	800-0100-02
	30mm P/S RW	1760-30-P/S-RW	800-0100-03
	50mm RO	1760-50-RO	800-0100-04
	50mm RW	1760-50-RW	800-0100-05
	50mm P/S RO	1760-50-P/S-RO	800-0100-06
	50mm P/S RW	1760-50-P/S-RW	800-0100-07

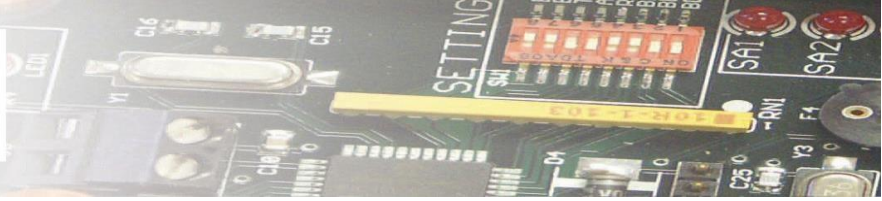

PVC Laminate & Fiberglass Disc Tags

Model 1761 Series

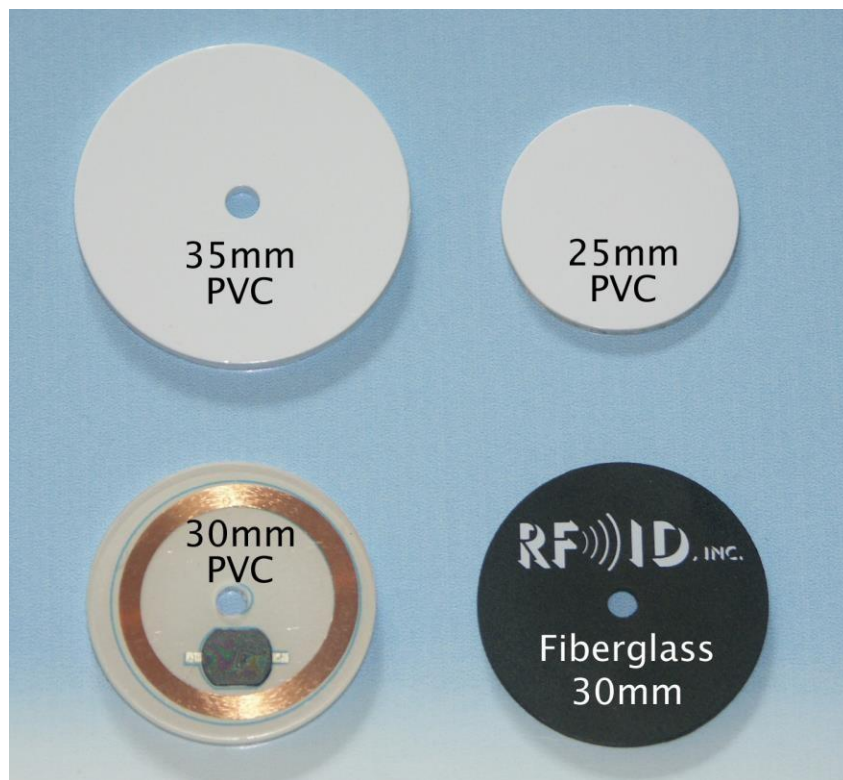

Specifications:	Dimensions:	25mm x 1mm, 30/35mm x 2mm	Custom Sizes Available
	Material:	PVC Laminate (white) Fiberglass (black)	Option Peel & Stick Backing
	Storage Temperature:	-40°F to 185°F	-40°C to +85°C
	Operating Temperature:	-40°F to +131°F	-40°C to +55°C
	Ingress Protection:	IP-68	

Part Numbering	Description	Model Number	Part Number
RO = Read Only	25mm RO, PVC	1761-25-RO	800-0101-00
RW = Read Write	25mm RW, PVC	1761-25-RW	800-0101-01
P/S = Peel & Stick	25mm P/S RO, PVC	1761-25-P/S-RO	800-0121-00
	25mm P/S RW, PVC	1761-25-P/S-RW	800-0121-01
	30mm RO w/center hole, PVC	1761-30-RO	800-0101-10
	30mm RW w/center hole, PVC	1761-30-RW	800-0101-11
	30mm P/S RO w/center hole, PVC	1761-30-P/S-RO	800-0121-10
	30mm P/S RW w/center hole, PVC	1761-30-P/S-RW	800-0121-11
	30mm RW w/center hole, Fiberglass	1761-30-RW-FIBER	800-0100-05-FIBER
For 134.2 KHz add suffix to P/N of -134	35mm RO w/center hole, PVC	1761-35-RO	800-0075-00
	35mm RW w/center hole, PVC	1761-35-RW	800-0075-01
	35mm RW w/center hole, PVC	1761-35-RW	800-0083-00 (148 KHz)

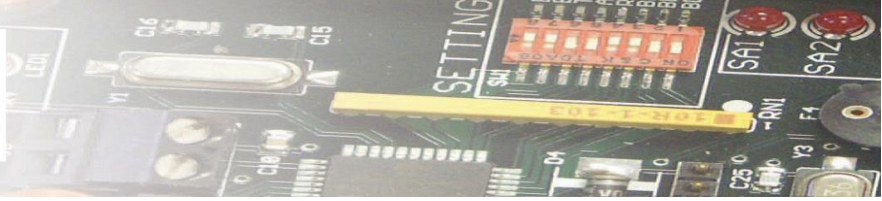

ABS Disc Tags

Model 1762 Series



Specifications:	Dimensions:	30mm x 2mm w/4mm hole 30mm x 5mm w/5mm hole 35mm x 4mm w/4mm hole 50mm x 8mm w/5mm hole	Custom Sizes Available
	Material:	ABS - Sonically Welded	Polycarbonate - Global Tag
	Storage Temperature:	-40°F to 185°F	-40°C to +85°C
	Operating Temperature:	-40°F to +131°F	-40°C to +55°C
	Ingress Protection:	IP-67	

Part Numbering	Description	Model Number	Part Number
RO = Read Only	30mm RO Global Tag	1762-30-RO	800-0118-00
RW = Read Write	30mm RW Global Tag	1762-30-RW	800-0118-01
	30mm RO ABS Disc Tag	1762-30-RO-WHT or -BLK	800-0118-02-WHT or -BLK
	30mm RW ABS Disc Tag	1762-30-RW-WHT or -BLK	800-0118-03-WHT or -BLK
	35mm RO ABS Disc Tag	1762-35-RO-WHT or -BLK	800-0118-04-WHT or -BLK
	35mm RW ABS Disc Tag	1762-35-RW-WHT or -BLK	800-0118-05-WHT or -BLK
For 134.2 KHz add suffix to P/N of -134	50mm RO ABS Disc Tag	1762-50-RO-WHT or -BLK	800-0118-06-WHT or -BLK
	50mm RW ABS Disc Tag	1762-50-RW-WHT or -BLK	800-0118-07-WHT or -BLK

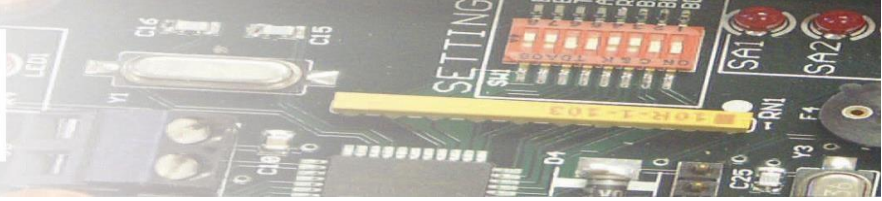

Potted Dome Tags

Model 1763 Series



Specifications:	Dimensions:	20mm x 2mm 50mm x 2mm 5mm center hole	Custom Sizes Available
	Material:	Potting Compound	
	Storage Temperature:	-40°F to 185°F	-40°C to +85°C
	Operating Temperature:	-40°F to +131°F	-40°C to +55°C
	Ingress Protection:	IP-68	

Part Numbering	Description	Model Number	Part Number
RO = Read Only	20mm P/S RO	1763-20-P/S-RO	800-0119-00
RW = Read Write	20mm P/S RW	1763-20-P/S-RW	800-0119-01
P/S = Peel & Stick	50mm P/S RO	1763-50-P/S-RO	800-0102-00
C/H = Center Hole	50mm P/S RW	1763-50-P/S-RW	800-0102-01
For 134.2 KHz	50mm C/H-RO	1763-50-C/H-RO	800-0102-00wHole
add suffix to P/N	50mm C/H RW	1763-50-C/H-RW	800-0102-01wHole
of -134			

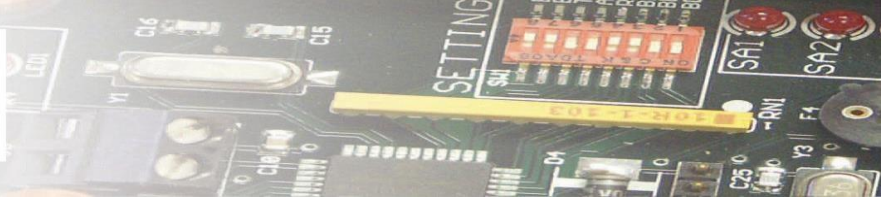

Keyfobs Model 1768 Series



Specifications:	Material:	See Description Below	Customized graphics or logo when applicable
	Storage Temperature:	-40°F to 185°F	-40°C to +85°C
	Operating Temperature:	-40°F to +131°F	-40°C to +55°C
	Ingress Protection:	IP-65 to P-68	

Part Numbering	Description	Part Number RO	Part Number RW
RO = Read Only	1 Fiberglass Keyfob	800-0109-04-RED or -BLK	800-0109-05-RED or -BLK
RW = Read Write	2 Epoxy Rectangle Small	800-0109-06	800-0109-07
	2 Epoxy Rectangle Large	800-0109-08	800-0109-09
HID compatible add suffix to P/N of -HID	3 Baseball Bat, ABS	800-0109-02	800-0109-03
	4 Leather Keyfob	800-0109-10-RED or -BLK -GRN	800-0109-11-RED or -BLK -GRN
	5 Aquatic Keyfob, ABS	800-0109-00-BLUE or -RED	800-0109-01-BLUE or -RED
	6 Teardrop Keyfob, ABS	800-0109-12-(assorted colors)	800-0109-13 (assorted colors)
	7 Epoxy Surfboard Keyfob	800-0109-14	800-0109-15
	8 Arch Keyfob, PVC Laminate	800-0109-16	800-0109-17



ISO Cards - Personnel Badges

Model 1770 Series



Photographed is ISO Card with Top Slot

Specifications:	Dimensions:	ISO Card - 86mm x 54mm	Clamshell - 86 x 54 x 2mm
	Material:	PVC, Laminate	Optional Printing
	Storage Temperature:	-40°F to 185°F	-40°C to +85°C
	Operating Temperature:	-40°F to +131°F	-40°C to +55°C
	Ingress Protection:	IP-67	

Part Numbering	Description	Model Number	Part Number
RO = Read Only	ISO Card - No Slot – RW	1770-RW	800-0077-00
RW = Read Write	ISO Card – w/Slot – RW	1770-TS-RW	800-0077-01
MS = Mag Swipe	ISO Card - MS – RO	1770-MS-RO	800-0106-00
TS = Top Slot	ISO Card - MS – RW	1770-MS-RW	800-0106-01
HID compatible	ISO Card - Top Slot – RO	1770-TS-RO	800-0107-00
Add HID Suffix	ISO Card - Top Slot – RW	1770-TS-RW	800-0107-01



Wrist Band Tags

Model 1771 Series



Specifications:	Material:	Soft Silicon Rubber	ABS w/Velcro Strap
		Private Label Options	ABS w/Watch Strap
	Storage Temperature:	-40°F to 185°F	-40°C to +85°C
	Operating Temperature:	-40°F to +131°F	-40°C to +55°C
	Ingress Protection:	IP-68	

Part Numbering	Description	Model Number	Part Number
RO = Read Only	ABS w/Watch Strap RO	1771-WS-RO	800-0110-00
RW = Read Write	ABS w/Watch Strap RW	1771-WS-RW	800-0110-01
Add -Color to	ABS w/Velcro Strap RO	1771-VL-RO	800-0110-03
Part Number	ABS w/Velcro Strap RW	1771-VL-RW	800-0110-04
HID compatible	Soft Silicon Rubber RO	1771-SL-RO	800-0110-05
add suffix to P/N of -HID	Soft Silicon Rubber RW	1771-SL-RW	800-0110-06

High Temperature Tags

Model 1772 Series

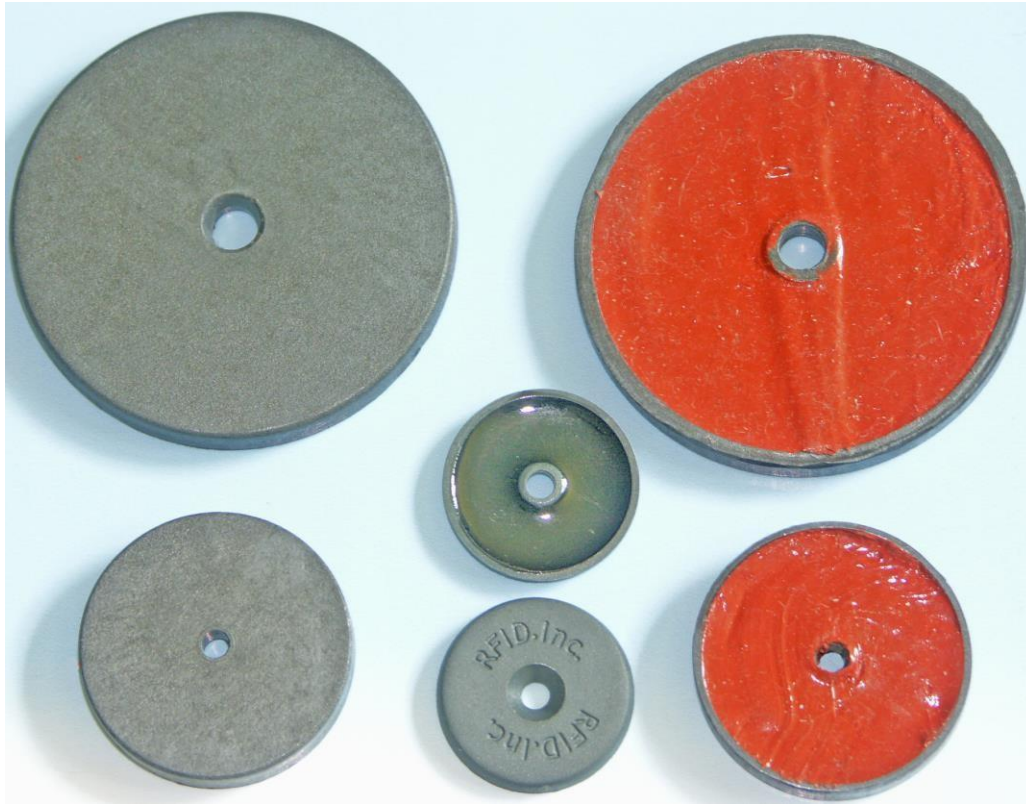

Specifications:	Dimensions:	22mm x 3mm w/3mm center 30mm x 5.8mm w/3mm center 50.2mm x 5.8mm w/5mm center	Countersunk Hole
	Material:	Proprietary	
	Storage Temperature 30 & 50mm Tags w/red fill:	-40°F to 482°F	-40°C to +250°C
	Operating Temperature 30 & 50mm Tags w/red fill:	-40°F to +446°F 15 hours 1x or 30 minute cycles	-40°C to +230°C
	Storage Temperature 22mm Tag w/black fill:	-40°F to +365°F	-40°C to +185°C
	Operating Temperature 22mm Tag w/black fill:	-40°F to +365°F Indefinite	-40°C to +185°C
	Ingress Protection:	IP-68	

Part Numbering	Description	Model Number	Part Number
RO = Read Only	22mm RO, Black	1772-22-RO-CS-HT	800-0074-00-CS-HT
	22mm RO, Black w/red fill	1772-22-RO-CS-UHT	800-0074-02-CS-UHT
RW = Read Write	22mm RW, Black	1772-22-RW	800-0074-02-CS
	22mm RW (148 KHz, Grey)	1772-22-RW	800-0080-01-CS (148 KHz)
CS = Countersunk	30mm RO, Black w/red fill	1772-30-RO	800-0074-07-HT
	30mm RW, Black w/red fill	1772-30-RW	800-0074-06-HT
	50mm RO, Black w/red fill	1772-50-RO	800-0074-08-HT
	50mm RW, Black w/red fill	1772-50-RW	800-0074-05-HT



In Metal Pot Core Tag

Model 1773



Specifications:	Dimensions:	8.5mm diameter x 5mm tall	
	Material:	Plastic shell with copper coil	
	Storage Temperature:	-40°F to 185°F	-40°C to +85°C
	Operating Temperature:	-40°F to +131°F	-40°C to +55°C
	Ingress Protection:	Inert to liquid	

Part Numbering	Description	Model Number	Part Number
RW = Read Write	In Metal Mount Pot Core RW	1773-RW	800-0210-00



Specifications: HID compatible add suffix to P/N of -HID	Dimensions:	12mm x 6mm x 3mm	
	Material:	Plastic	
	Storage Temperature:	-40°F to 185°F	-40°C to +85°C
	Operating Temperature:	-40°F to +131°F	-40°C to +55°C
	Ingress Protection:	IP-68	

Part Numbering	Description	Model Number	Part Number
RW = Read Write	Coffin Tag	1774-RW	800-0084-01

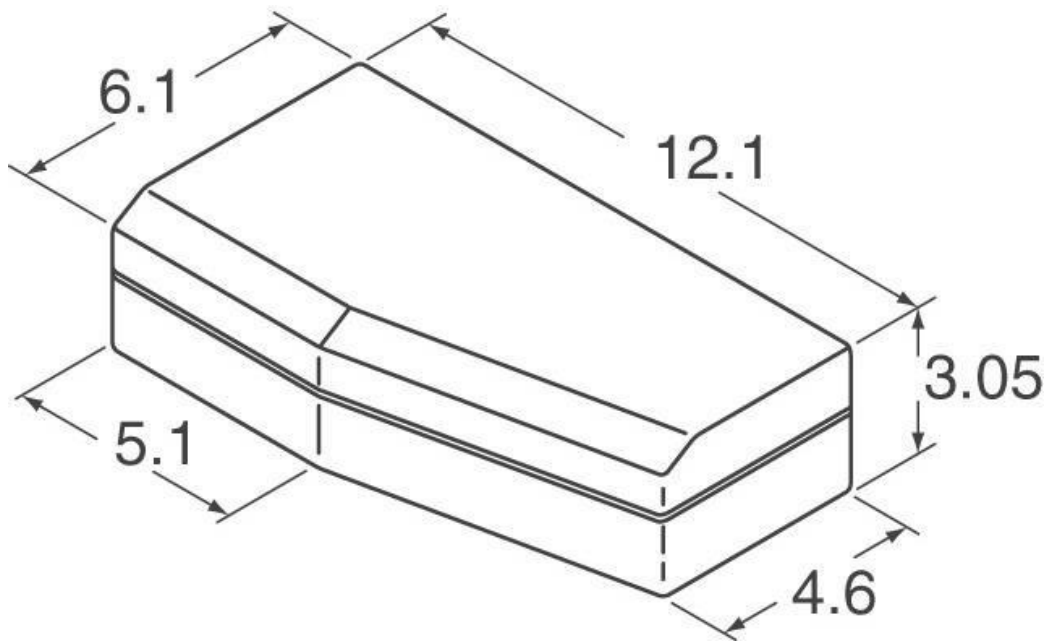

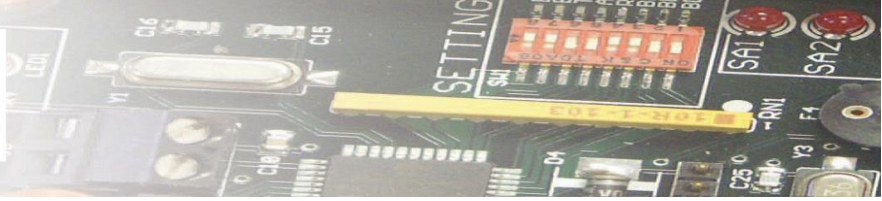

Glass Ampoule Tags

Model 1775 Series



Depicted is 3 x 13 mm

Environment:	Dimensions:	2x12mm, 3x13mm, 3x34mm	Custom Sizes Available
	Material:	Glass	
	Storage Temperature:	-40°F to 185°F	-40°C to +85°C
	Operating Temperature:	-40°F to +131°F	-40°C to +55°C
	Ingress Protection:	IP-68	

Part Numbering	Description	Model Number	Part Number
RO = Read Only	3x13mm Glass Ampoule RO	1775-313-RO	800-0073-00
RW = Read Write	3x13mm Glass Ampoule RW	1775-313-RW	800-0073-01
HTS = HitagS	2x12mm Glass Ampoule RO	1775-212-RO	800-0073-02
	2x12mm Glass Ampoule RW	1775-212-RW	800-0073-05-SA
For 134.2 KHz add suffix to P/N of -134	2x12mm Glass Ampoule RW w/HitagS chip	1775-212-HTS-RW	800-0073-05
	4x34mm Glass Ampoule RO	1775-434-RO	800-0073-04
	4x34mm Glass Ampoule RW	1775-434-RW	800-0073-03



Animal Tags - ISO 11784/11785

Model 1776 Series



Specifications: ISO 11784 ISO 11785 HDX FDX & FDX-B	Dimensions:	Round - 30mm diameter	Square - 71mm x 81mm
		Rectangle - 54mm x 19mm	
	Material:	TPU	
	Storage Temperature:	-40°F to 185°F	-40°C to +85°C
	Operating Temperature:	-40°F to +131°F	-40°C to +55°C
	Ingress Protection:	IP-68	

Part Numbering	Description	Model Number	Part Number
All Tags Come With 134.2 KHz Chip	Round Ear Tag	1776-RND	800-0126-00
	Rectangular Ear Tag	1776-RECT	800-0126-01
	Square Ear Tag	1776-SQR	800-0126-02
	Ear Tag Applicator	1776-APP	800-0126-50
	2x12mm Tag w/Syringe	1776-SYR	800-0127-00



Syringe Kit comes with 3 bar code labels





Nail, Screw & Specialty Tags

Model 1777 Series



Specifications:	Dimensions:	See Description Below	
	Material:	ABS, PC Nylon	2 Part Epoxy
	Storage Temperature:	-40°F to 185°F	-40°C to +85°C
	Operating Temperature:	-40°F to +131°F	-40°C to +55°C
	Ingress Protection:	IP-68	

Part Numbering	Description	Model Number	Part Number
RO = Read Only RW = Read Write For 134.2 KHz add suffix to P/N of -134	1 Threaded Plug Tag, 30x15mm RO	1777-TP-RO	800-0130-00
	1 Threaded Plug Tag, 30x15mm RW	1777-TP-RW	800-0130-01
	2 Threaded Bolt Tag, 16x25mm RO	1777-TB16-RO	800-0131-00
	2 Threaded Bolt Tag, 16x25mm RW	1777-TB16RW	800-0131-01
	3 Threaded Screw Tag, 11x26mm RO	1777-TS11-RO	800-0132-00
	3 Threaded Screw Tag, 11x26mm RW	1777-TS11-RW	800-0132-01
	4 Threaded Bolt Tag, 13x25mm RO	1777-TB13-RO	800-0133-00
	4 Threaded Bolt Tag, 13x25mm RO	1777-TB13-RW	800-0133-01
	5 Nail Tag, 35x4mm RO	1777-NT-RO	800-0111-00
	5 Nail Tag, 35x4mm RW	1777-NT-RW	800-0111-01
	6 8.7mm ID Poultry or Cable Tag RO	1777-PC87-RO	800-0140-00
	6 8.7mm ID Poultry or Cable Tag RW	1777-PC87-RW	800-0140-01
	7 7.8mm ID Poultry or Cable Tag RO	1777-PC78-RO	800-0141-00
	7 7.8mm ID Poultry or Cable Tag RW	1777-PC78-RW	800-0141-01
	8 20mm ID Poultry or Cable Tag RO	1777-PC20-RO	800-0142-00
	8 20mm ID Poultry or Cable Tag RW	1777-PC20-RW	800-0142-01



**12mm Pill Tag
Laundry Tags**

**Model 1778 Series
Model 1779 Series**

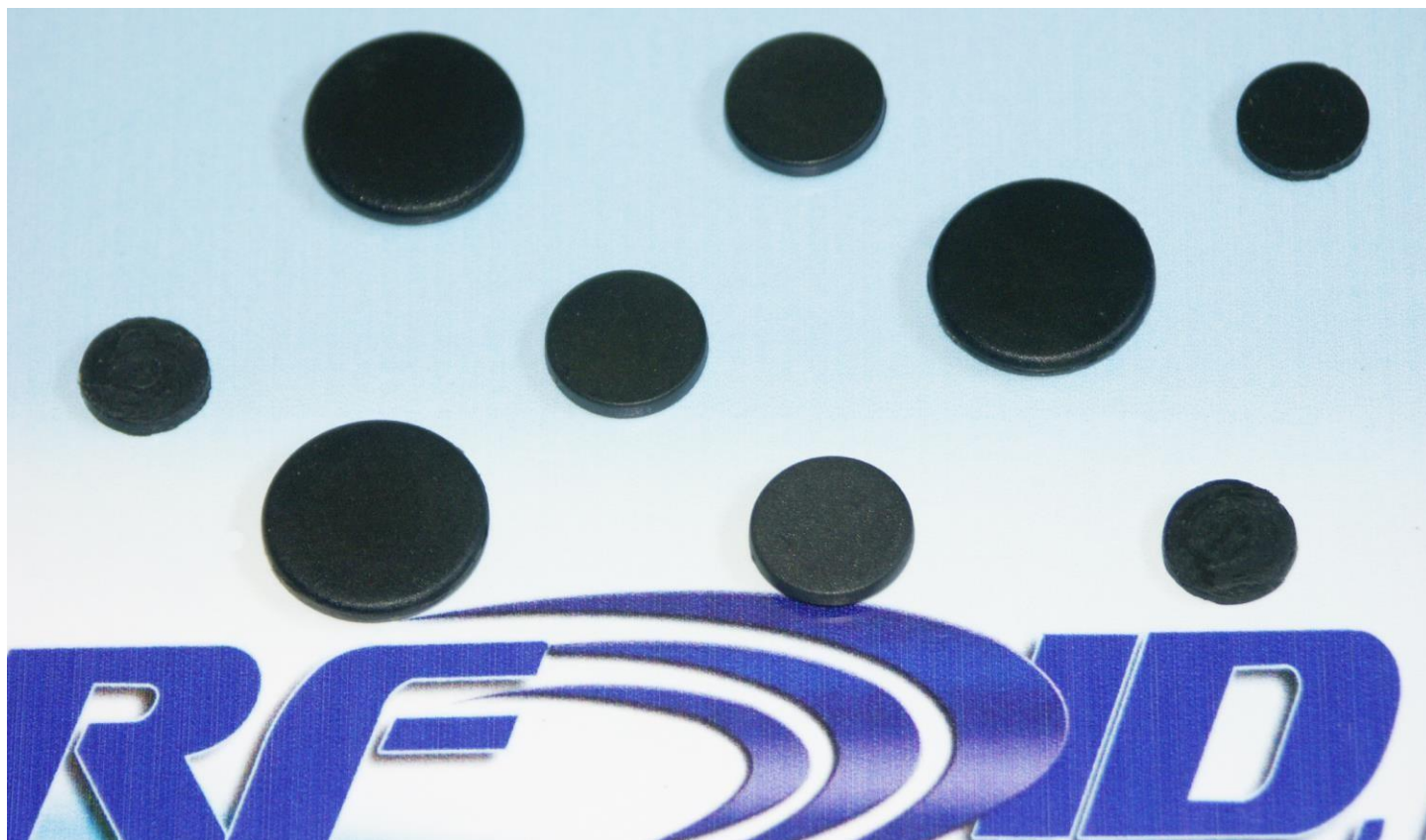

Specifications:	Dimensions: Laundry Tag	9, 10, 11, 12, 13, 14, 15, 16, 17mm	18, 20, 22, 24, 26, 28, 30mm
	Pill Tag	12mm	Custom Sizes Available
	Material:	PPS + Epoxy	
	Storage Temperature:	-20°F to +248°F indefinite -20°C to +320°F 30 min-200x -20°C to +392°F 30 sec-200x	-20°C to +120°C indefinite -20°C to +160°C 30 min-200x -20°C to +200°C 30 sec-200x
	Operating Temperature:	-40°F to +185°F	-40°C to +85°C
	Ingress Protection:	IP-68	
	Water Pressure:	300 Bars - 5 minutes	45 Bars - 10 hours
	Axial Compression Strength:	1000 N - 10 seconds	
	Radial Compression Strength:	1000 N - 10 seconds	

Part Numbering	Description	Model Number	Part Number
RO = Read Only	xxmm Laundry Tag RO	1779-xx-RO (xx=diameter in mm's)	800-0113-00/xx (dia in mm's)
RW = Read Write	xxmm Laundry Tag RW	1779-xx-RW (xx=diameter in mm's)	800-0113-01/xx (dia in mm's)
	12mm Pill Tag RO	1778-12-RO	800-0112-00
	12mm Pill Tag RW	1778-12-RW	800-0112-01

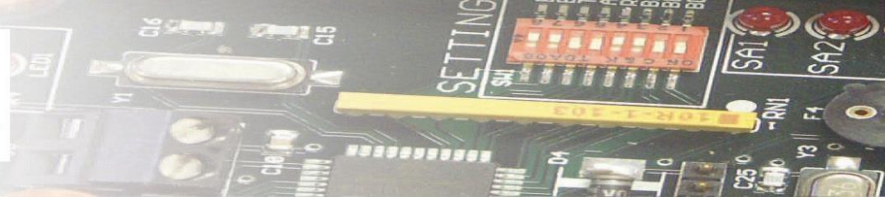

Metal Mount Bar Tags

Models 1781M1 & 1781M2 Series



Specifications:	Dimensions:	3.50" x 0.90" x 0.70"	89mm X 23mm x 17mm
	Material:	Rynite PET w/potting compound	
	Storage Temperature:	-40°F to 185°F	-40°C to +85°C
	Operating Temperature:	-40°F to +131°F	-40°C to +55°C
	Ingress Protection:	IP-68	

Part Numbering	Description	Model Number	Part Number
RW = Read Write	Bar Tag, ferrite coil, 148 KHz	1781M1-RW-148	800-0015-02 (148 KHz)
	Bar Tag, planar coil, 148 KHz	1781M2-RW-148	800-0015-03 (148 KHz)
	Bar Tag, ferrite coil, 125 KHz	1781M1-RW	800-0015-04
	Bar Tag, planar coil, 125 KHz	1781M2-RW	800-0015-05

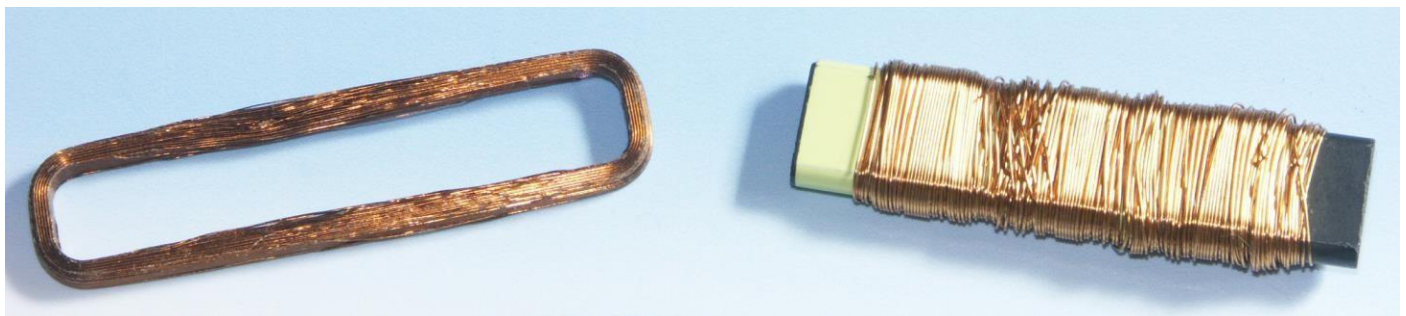

PLANAR COIL

FERRITE COIL

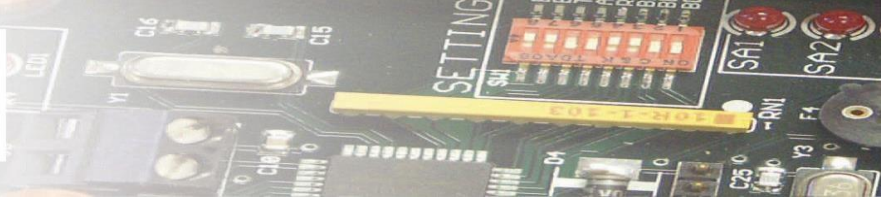

TTT (Tough Thin Tag) Model 1783 Series
With Black Attachment Housing



Specifications:	Dimensions:	1783 Tag	3.38" x 2.13" x 0.16"	86mm x 54mm x 4mm
		1783 Attachment Housing	4.62" x 2.64" x 0.25" w/0.203 hole	117mm x 67mm x 6mm
	Material:		Polycarbonate Halves, Sonic Weld	ABS Attachment Housing
	Storage Temperature:		-40°F to 185°F	-40°C to +85°C
	Operating Temperature:		-40°F to +131°F	-40°C to +55°C
	Ingress Protection:		IP-67	

Part Numbering	Description	Model Number	Part Number
RW = Read Write	Tough Thin Tag, RW	1783-RW-148	800-0007-03 (148 KHz)
	Tough Thin Tag, RW	1783-RW	800-0007-04
	Attachment Housing	1783H	473-0033-00

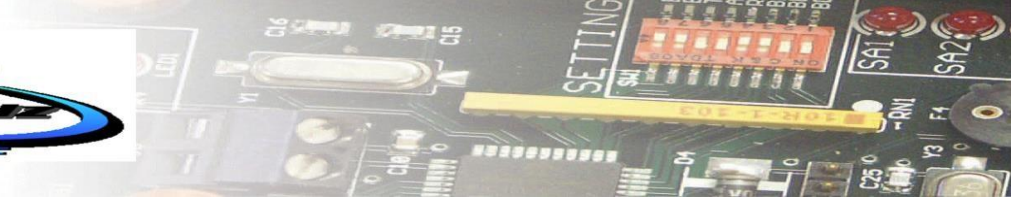

Hockey Puck Tag

Model 1786 Series



Specifications:	Dimensions:	3.35" x 1.19" w/0.265" holes	85mm x 30mm w/6.7mm holes
	Weight:	4.8 oz.	135 grams
	Material:	Housing: Nylon w/30% Glass Fill	Epoxy: 2 Part Compound
	Storage Temperature:	-40°F to 365°F	-40°C to +185°C
	Operating Temperature:	-40°F to +365°F	-40°C to +185°C
	Ingress Protection:	IP-68	

Part Numbering	Description	Model Number	Part Number
RO = Read Only	Hockey Puck Tag RW 148 KHz	1786-RW-148	800-0059-00 (148 KHz)
RW = Read Write	Hockey Puck Tag RW 125 KHz	1786-RW-125	800-0059-04

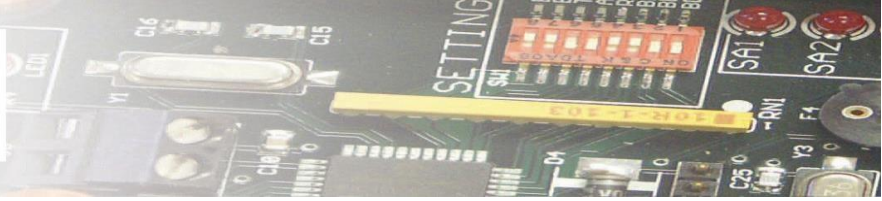

Lipstick Tag

Model 1787 Series



Specifications:	Dimensions:	2.3" x 0.75"	58mm x 19mm
	Material:	Polycarbonate	2 Part Potting Compound
	Storage Temperature:	-40°F to 185°F	-40°C to +85°C
	Operating Temperature:	-40°F to +131°F	-40°C to +55°C
	Ingress Protection:	IP-68	

Part Numbering	Description	Model Number	Part Number
RO = Read Only	Lipstick Tag RW	1787-RW-148	800-0017-02 (148 KHz)
RW = Read Write	Lipstick Tag RW	1787-RW	800-0017-04

Specifically designed for in floor mount, AGV applications.



Tank Tag

Model 1788



Specifications:	Dimensions:	1.225" diameter x .0325"	31mm x 8mm
	Material:	ABS	2 Part Potting Compound
	Storage Temperature:	-40°F to 185°F	-40°C to +85°C
	Operating Temperature:	-40°F to +131°F	-40°C to +55°C
	Ingress Protection:	IP-68	

Part Numbering	Description	Model Number	Part Number
RO = Read Only	Cylinder Tank Tag, RO	1788-RO	800-0092-00
RW = Read Write	Cylinder Tank Tag, RW	1788-RW	800-0092-01

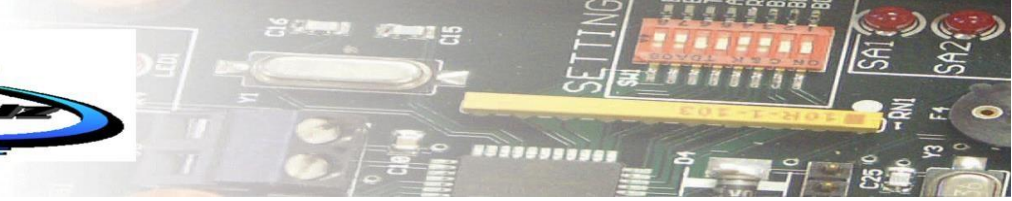

**Deck of Cards Tag
Models 1791 & 1791M Series**



**Frisbee Tag
Model 1795 Series**



Ferrite Coil sits in the center

Planar Coil is larger flat Coil

Specifications:	Dimensions: 1791	4" x 2.12" x 0.54" w/0.18"holes	101 x 54mm w/4.6mm holes
	1795	6" diameter x 0.6" w/0.30" holes	152 x 15mm w/7.6mm holes
	Material:	Polycarbonate	2 Part Potting Compound
	Storage Temperature:	-40°F to 185°F	-40°C to +85°C
	Operating Temperature:	-40°F to +131°F	-40°C to +55°C
	Ingress Protection:	IP-68	

Part Numbering	Description	Model Number	Part Number
RO = Read Only RW = Read Write	Deck of Cards Tag, Planar Coil	1791-RW-148	800-0020-00 (148 KHz)
	Deck of Cards Tag, Planar Coil	1791-RW	800-0020-04
	Deck of Cards Tag, Ferrite Coil	1791M-RW-148	800-0020-01 (148 KHz)
	Deck of Cards Tag, Ferrite Coil	1791M-RW	800-0021-04
	Frisbee Tag	1795-RW-148	800-0026-00 (148 KHz)
	Frisbee Tag	1795-RW	800-0026-04

Clear Laminate Monster Tags

Models 1796 & 1796SM Series



The Model 1796SM is shown laying atop the Model 1796.

These Tags were made for the sole purpose of maximizing read ranges when needed.

Specifications:	Dimensions:	1796	8" x 6.75"	203mm x 170mm
		1796SM	5.125" x 3.5625"	130mm x 90mm
	Material:	Clear Laminate		Custom Sizes Available
	Storage Temperature:	-40°F to 185°F		-40°C to +85°C
	Operating Temperature:	-40°F to +131°F		-40°C to +55°C
	Ingress Protection:	IP-67		

Part Numbering	Description	Model Number	Part Number
RO = Read Only	Monster Tag, P/S Tape, RO	1796RO	800-0114-00
RW = Read Write	Monster Tag, P/S Tape, RW	1796-RW	800-0114-01
P/S = Peel & Stick	Small Monster, RO	1796SM-RO	800-0122-00
	Small Monster, RW	1796SM-RW	800-0122-01



Read Range Matrix (in Inches) (Write Range is 5% to 30% less than Read Range dependent upon combination)

Valid only for R3-2 125 KHz Smart Antenna Systems

For R3-1 125 KHz Legacy & R3 148 KHz Legacy Read Ranges, See Those Reader Line Data Sheets

Tag Model Number	Smart Antenna Model	5100	5110	5120	5130	5131	5150	5155	5160	5180	5181
20mm diameter Tags 1760 – 1761 – 1763		1.0	1.25	.50	Dependent	.75	1.5	2.5	--	1.0	1.0
25mm diameter Tags 1761 -		1.0	1.5	.75	On	.75	2.25	3.0	--	1.25	1.0
30mm diameter Tags 1760 – 1761 – 1762		1.25	2.0	1.75	External	1.0	3.5	4.5	--	2.0	1.0
35mm diameter Tags 1761 - 1762		1.5	2.0	1.75	Antenna	1.25	3.75	4.5	1.25	2.0	1.0
50mm diameter Tags 1760 - 1763		2.0	3.75	3.0		1.5	5.5	6.5	5.0	3.25	1.0
1768 Keyfobs (based on average 20mm coil)		1.0	1.25	.5		.75	1.5	2.5	--	1.0	1.0
1770 Personnel Badge, ISO Card		2.0	3.0	3.25		1.5	6.0	7.0	5.25	3.5	1.0
1771 Wrist Bands		1.0	1.25	.5		.75	1.5	2.5	--	1.0	1.0
1772 22mm High Temp		1.25	2.0	1.25		1.0	3.25	4.0	--	1.5	1.0
1772-HT30 High Temp 30mm		1.5	2.0	1.5		1.0	3.5	4.0	1.0	1.0	1.0
1772-HT50 High Temp 50mm		2.0	2.5	2.5		1.5	5.0	5.5	4.5	3.5	1.0
1773 In Metal Pot Core		.25	.25	-		.25	--	--	--	.25	--
1774 Wedge/Coffin		.75	1.5	.50	Dependent	.50	1.25	3.0	--	.75	--
1775 Glass Ampoule (3x13mm)		1.0	1.25	-	On	1.0	1.0	2.0	--	1.25	--
1776 Animal Ear Tag					External						
1778 12mm Pill Tag		.75	1.00	--	Antenna	.50	--	3.25	--	.25	--
1779 Laundry Tag (based on 16mm version)		.75	1.25	.50		.50	1.0	2.0	--	1.0	--
1781M1 Bar Tag, Ferrite coil		1.0	2.25	4.0		.75	5.25	7.0	6.25	2.75	1.0
1781M2 Bar Tag, Planar coil		1.25	2.25	2.0		1.0	4.5	5.5	3.0	2.5	1.0
1783 TTT		2.25	3.5	4.0		1.75	7.0	7.0	7.5	4.0	1.0
1786 Hockey Puck		2.25	3.5	4.0		1.75	7.0	7.0	8.0	4.0	1.0
1787 Lipstick Tag		1.5	2.75	3.25		1.25	5.25	7.0	6.25	2.75	1.0
1788 Tank Tag		1.0	1.5	.50		.75	1.75	2.5	--	1.0	1.0
1791 Deck of Cards Planar Coil		2.25	3.5	4.0		1.75	7.0	7.0	7.5	4.0	1.0
1791M Deck of Cards Ferrite Coil		1.0	2.25	4.0	Dependent	.75	5.25	7.0	6.25	2.75	1.0
1795 Frisbee Tag, 6" diameter		3.0	5.0	7.0	On	2.25	11.0	13.0	14.0	7.5	1.0
1796SM Mini-Monster Tag		2.5	4.0	5.5	External	2.0	9.0	10.0	10.0	5.0	1.0
1796 Monster Tag, 8" x 6.75"		3.0	5.25	8.5	Antenna	2.25	12.0	15.0	15.0	8.0	1.0